



The Leading Open Source Backup Solution

Bacula Main Reference

Kern Sibbald

July 4, 2015

This manual documents Bacula version 7.0.5 (28 July 2014)

Copyright © 1999-2014, Free Software Foundation Europe e.V.
Bacula is a registered trademark of Kern Sibbald.

This Bacula documentation by Kern Sibbald with contributions from many
others,
a complete list can be found in the License chapter. Creative Commons

Attribution-ShareAlike 4.0 International License
<http://creativecommons.org/licenses/by-sa/4.0/>





Contents

1	What is Bacula?	1
1.1	Who Needs Bacula?	1
1.2	Bacula Components or Services	1
1.3	Bacula Configuration	3
1.4	Conventions Used in this Document	4
1.5	Quick Start	4
1.6	Terminology	4
1.7	What Bacula is Not	7
1.8	Interactions Between the Bacula Services	7
2	New Features in 7.0.0	9
2.1	New Features in 7.0.0	9
2.1.1	Storage daemon to Storage daemon	9
2.1.2	SD Calls Client	9
2.1.3	Next Pool	10
2.1.4	status storage	10
2.1.5	status schedule	10
2.1.6	Data Encryption Cipher Configuration	11
2.1.7	New Truncate Command	11
2.1.8	Migration/Copy/VirtualFull Performance Enhancements	11
2.1.9	VirtualFull Backup Consolidation Enhancements	12
2.1.10	FD Storage Address	12
2.1.11	Job Bandwidth Limitation	13
2.1.12	Maximum Concurrent Read Jobs	14
2.1.13	Director job Codes in Message Resource Commands	14
2.1.14	Additions to RunScript variables	14
2.1.15	Read Only Storage Devices	15
2.1.16	New Prune “Expired” Volume Command	15
2.1.17	Hardlink Performance Enhancements	15
2.1.18	DisableCommand Directive	15
2.1.19	Multiple Console Directors	16
2.1.20	Restricted Consoles	16
2.1.21	Configuration Files	16
2.1.22	Maximum Spawned Jobs	16
2.1.23	Progress Meter	16
2.1.24	Scheduling a 6th Week	16
2.1.25	Scheduling the Last Day of a Month	16
2.1.26	Improvements to Cancel and Restart bconsole Commands	16
2.1.27	bconsole Performance Improvements	16
2.1.28	New .bvfs_decode_lstat Command	17
3	New Features in 5.2.13	19
3.0.1	Additions to RunScript variables	19
3.1	New Features in 5.2.1	19
3.1.1	LZO Compression	19
3.1.2	New Tray Monitor	19
3.1.3	Purge Migration Job	21
3.1.4	Changes in Bvfs (Bacula Virtual FileSystem)	21



- 3.1.5 Changes in the Pruning Algorithm 24
- 3.1.6 Ability to Verify any specified Job 24
- 3.1.7 Additions to RunScript variables 25
- 3.1.8 Additions to the Plugin API 25
- 3.1.9 ACL enhancements 27
- 3.1.10 XATTR enhancements 27
- 3.1.11 Class Based Database Backend Drivers 28
- 3.1.12 Hash List Enhancements 29
- 3.2 Release Version 5.0.3 29
- 3.3 Release Version 5.0.2 29
- 3.4 New Features in 5.0.1 29
 - 3.4.1 Truncate Volume after Purge 29
 - 3.4.2 Allow Higher Duplicates 30
 - 3.4.3 Cancel Lower Level Duplicates 30
- 3.5 New Features in 5.0.0 30
 - 3.5.1 Maximum Concurrent Jobs for Devices 30
 - 3.5.2 Restore from Multiple Storage Daemons 30
 - 3.5.3 File Deduplication using Base Jobs 30
 - 3.5.4 AllowCompression = <yes|no> 31
 - 3.5.5 Accurate Fileset Options 31
 - 3.5.6 Tab-completion for Bconsole 32
 - 3.5.7 Pool File and Job Retention 32
 - 3.5.8 Read-only File Daemon using capabilities 32
 - 3.5.9 Bvfs API 32
 - 3.5.10 Testing your Tape Drive 33
 - 3.5.11 New **Block Checksum** Device Directive 33
 - 3.5.12 New Bat Features 33
 - 3.5.13 Bat on Windows 34
 - 3.5.14 New Win32 Installer 34
 - 3.5.15 Win64 Installer 36
 - 3.5.16 Linux Bare Metal Recovery USB Key 36
 - 3.5.17 bconsole Timeout Option 36
 - 3.5.18 Important Changes 36
 - 3.5.19 Misc Changes 37
- 4 Released Version 3.0.3 and 3.0.3a 39**
 - 4.1 New Features in Released Version 3.0.2 39
 - 4.1.1 Full Restore from a Given JobId 39
 - 4.1.2 Source Address 39
 - 4.1.3 Show volume availability when doing restore 40
 - 4.1.4 Accurate estimate command 40
 - 4.2 New Features in 3.0.0 40
 - 4.2.1 Accurate Backup 41
 - 4.2.2 Copy Jobs 41
 - 4.2.3 ACL Updates 43
 - 4.2.4 Extended Attributes 44
 - 4.2.5 Shared objects 45
 - 4.2.6 Building Static versions of Bacula 45
 - 4.2.7 Virtual Backup (Vbackup) 45
 - 4.2.8 Catalog Format 47
 - 4.2.9 64 bit Windows Client 47
 - 4.2.10 Duplicate Job Control 48
 - 4.2.11 TLS Authentication 48
 - 4.2.12 bextract non-portable Win32 data 49
 - 4.2.13 State File updated at Job Termination 49
 - 4.2.14 MaxFullInterval = <time-interval> 49
 - 4.2.15 MaxDiffInterval = <time-interval> 49
 - 4.2.16 Honor No Dump Flag = <yes|no> 49
 - 4.2.17 Exclude Dir Containing = <filename-string> 49
 - 4.2.18 Bacula Plugins 50



4.2.19	The bpipe Plugin	51
4.2.20	Microsoft Exchange Server 2003/2007 Plugin	51
4.2.21	libdbi Framework	54
4.2.22	Console Command Additions and Enhancements	55
4.2.23	Bare Metal Recovery	55
4.2.24	Miscellaneous	56
5	The Current State of Bacula	61
5.1	What is Implemented	61
5.2	Advantages Over Other Backup Programs	63
5.3	Current Implementation Restrictions	63
5.4	Design Limitations or Restrictions	64
5.5	Items to Note	64
6	System Requirements	65
7	Supported Operating Systems	67
8	Supported Tape Drives	69
8.1	Unsupported Tape Drives	70
8.2	FreeBSD Users Be Aware!!!	70
8.3	Supported Autochangers	70
8.4	Tape Specifications	70
9	Getting Started with Bacula	73
9.1	Understanding Jobs and Schedules	73
9.2	Understanding Pools, Volumes and Labels	73
9.3	Setting Up Bacula Configuration Files	74
9.3.1	Configuring the Console Program	74
9.3.2	Configuring the Monitor Program	74
9.3.3	Configuring the File daemon	75
9.3.4	Configuring the Director	75
9.3.5	Configuring the Storage daemon	76
9.4	Testing your Configuration Files	76
9.5	Testing Compatibility with Your Tape Drive	76
9.6	Get Rid of the /lib/tls Directory	76
9.7	Running Bacula	77
9.8	Log Rotation	77
9.9	Log Watch	77
9.10	Disaster Recovery	77
10	Installing Bacula	79
10.1	Source Release Files	79
10.2	Upgrading Bacula	79
10.3	Releases Numbering	80
10.4	Dependency Packages	81
10.5	Supported Operating Systems	82
10.6	Building Bacula from Source	83
10.7	What Database to Use?	85
10.8	Quick Start	85
10.9	Configure Options	86
10.10	Recommended Options for Most Systems	91
10.11	Red Hat	91
10.12	Solaris	92
10.13	FreeBSD	93
10.14	Win32	93
10.15	One File Configure Script	93
10.16	Installing Bacula	93
10.17	Building a File Daemon or Client	94
10.18	Auto Starting the Daemons	94
10.19	Other Make Notes	94



10.20	Installing Tray Monitor	95
10.20.1	GNOME	95
10.20.2	KDE	95
10.20.3	Other Window Managers	96
10.21	Modifying the Bacula Configuration Files	96
11	Critical Items to Implement Before Production	97
11.1	Critical Items	97
11.2	Recommended Items	98
12	A Brief Tutorial	99
12.1	Before Running Bacula	99
12.2	Starting the Database	99
12.3	Starting the Daemons	100
12.4	Using the Director to Query and Start Jobs	100
12.5	Running a Job	101
12.6	Restoring Your Files	105
12.7	Quitting the Console Program	106
12.8	Adding a Second Client	106
12.9	When The Tape Fills	108
12.10	Other Useful Console Commands	109
12.11	Debug Daemon Output	109
12.12	Patience When Starting Daemons or Mounting Blank Tapes	110
12.13	Difficulties Connecting from the FD to the SD	110
12.14	Daemon Command Line Options	110
12.15	Creating a Pool	111
12.16	Labeling Your Volumes	111
12.17	Labeling Volumes with the Console Program	111
13	Customizing the Configuration Files	113
13.1	Character Sets	114
13.2	Resource Directive Format	114
13.2.1	Comments	114
13.2.2	Upper and Lower Case and Spaces	114
13.2.3	Including other Configuration Files	115
13.2.4	Recognized Primitive Data Types	115
13.3	Resource Types	116
13.4	Names, Passwords and Authorization	116
13.5	Detailed Information for each Daemon	117
14	Configuring the Director	119
14.1	Director Resource Types	119
14.2	The Director Resource	120
14.3	The Job Resource	122
14.4	The JobDefs Resource	138
14.5	The Schedule Resource	138
14.6	Technical Notes on Schedules	140
14.7	The FileSet Resource	140
14.8	FileSet Examples	152
14.9	Backing up Raw Partitions	156
14.10	Excluding Files and Directories	156
14.11	Windows FileSets	156
14.12	Testing Your FileSet	158
14.13	The Client Resource	159
14.14	The Storage Resource	160
14.15	The Pool Resource	162
14.15.1	The Scratch Pool	168
14.16	The Catalog Resource	168
14.17	The Messages Resource	169
14.18	The Console Resource	169
14.19	The Counter Resource	170

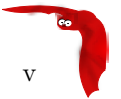

14.20	Example Director Configuration File	171
15	Client/File daemon Configuration	175
15.1	The Client Resource	175
15.2	The Director Resource	177
15.3	The Message Resource	178
15.4	Example Client Configuration File	178
16	Storage Daemon Configuration	179
16.1	Storage Resource	179
16.2	Director Resource	181
16.3	Device Resource	181
16.4	Edit Codes for Mount and Unmount Directives	188
16.5	Devices that require a mount (USB)	188
17	Autochanger Resource	191
17.1	Capabilities	192
17.2	Messages Resource	192
17.3	Sample Storage Daemon Configuration File	192
18	Messages Resource	195
19	Console Configuration	199
19.1	General	199
19.2	The Director Resource	199
19.3	The ConsoleFont Resource	199
19.4	The Console Resource	200
19.5	Console Commands	202
19.6	Sample Console Configuration File	202
20	Monitor Configuration	203
20.1	The Monitor Resource	203
20.2	The Director Resource	203
20.3	The Client Resource	204
20.4	The Storage Resource	204
20.5	Tray Monitor Security	205
20.6	Sample Tray Monitor configuration	205
20.6.1	Sample File daemon's Director record.	205
20.6.2	Sample Storage daemon's Director record.	205
20.6.3	Sample Director's Console record.	206
21	The Restore Command	207
21.1	General	207
21.2	The Restore Command	207
21.2.1	Restore a pruned job using a pattern	211
21.3	Selecting Files by Filename	212
21.4	Replace Options	213
21.5	Command Line Arguments	213
21.6	Using File Relocation	214
21.6.1	Introduction	214
21.6.2	RegexWhere Format	214
21.7	Restoring Directory Attributes	215
21.8	Restoring on Windows	215
21.9	Restoring Files Can Be Slow	215
21.10	Problems Restoring Files	216
21.11	Restore Errors	216
21.12	Example Restore Job Resource	217
21.13	File Selection Commands	217
21.14	Restoring When Things Go Wrong	218



22 Automatic Volume Recycling	223
22.1 Automatic Pruning	224
22.2 Pruning Directives	224
22.3 Recycling Algorithm	225
22.4 Recycle Status	227
22.5 Making Bacula Use a Single Tape	227
22.6 Daily, Weekly, Monthly Tape Usage Example	228
22.7 Automatic Pruning and Recycling Example	229
22.8 Manually Recycling Volumes	230
23 Basic Volume Management	233
23.1 Key Concepts and Resource Records	233
23.1.1 Pool Options to Limit the Volume Usage	234
23.1.2 Automatic Volume Labeling	234
23.1.3 Restricting the Number of Volumes and Recycling	235
23.2 Concurrent Disk Jobs	236
23.3 An Example	236
23.4 Backing up to Multiple Disks	238
23.5 Considerations for Multiple Clients	239
24 Automated Disk Backup	243
24.1 The Problem	243
24.2 The Solution	243
24.3 Overall Design	243
24.3.1 Full Pool	244
24.3.2 Differential Pool	244
24.3.3 Incremental Pool	245
24.4 The Actual Conf Files	245
25 Migration and Copy	249
25.1 Migration and Copy Job Resource Directives	250
25.2 Migration Pool Resource Directives	251
25.3 Important Migration Considerations	252
25.4 Example Migration Jobs	253
26 File Deduplication using Base Jobs	255
27 Backup Strategies	257
27.1 Simple One Tape Backup	257
27.1.1 Advantages	257
27.1.2 Disadvantages	257
27.1.3 Practical Details	257
27.2 Manually Changing Tapes	257
27.3 Daily Tape Rotation	258
27.3.1 Advantages	258
27.3.2 Disadvantages	258
27.3.3 Practical Details	259
28 Autochanger Support	263
28.1 Knowing What SCSI Devices You Have	264
28.2 Example Scripts	264
28.3 Slots	265
28.4 Multiple Devices	265
28.5 Device Configuration Records	265
29 Autochanger Resource	267
29.1 An Example Configuration File	268
29.2 A Multi-drive Example Configuration File	268
29.3 Specifying Slots When Labeling	269
29.4 Changing Cartridges	269
29.5 Dealing with Multiple Magazines	269



29.6	Simulating Barcodes in your Autochanger	270
29.7	The Full Form of the Update Slots Command	270
29.8	FreeBSD Issues	271
29.9	Testing Autochanger and Adapting mtx-changer script	271
29.10	Using the Autochanger	272
29.11	Barcode Support	273
29.12	Use bconsole to display Autochanger content	274
29.13	Bacula Autochanger Interface	274
30	Supported Autochangers	275
31	Data Spooling	277
31.1	Data Spooling Directives	277
31.2	!!! MAJOR WARNING !!!	278
31.3	Other Points	278
32	Using Bacula catalog to grab information	279
32.1	Job statistics	279
33	ANSI and IBM Tape Labels	281
33.1	Director Pool Directive	281
33.2	Storage Daemon Device Directives	281
34	The Windows Version of Bacula	283
34.1	Windows Installation	283
34.2	Post Windows Installation	287
34.3	Uninstalling Bacula on Windows	287
34.4	Dealing with Windows Problems	287
34.5	Windows Compatibility Considerations	289
34.6	Volume Shadow Copy Service	290
34.7	VSS Problems	291
34.8	Windows Firewalls	291
34.9	Windows Port Usage	291
34.10	Windows Disaster Recovery	291
34.11	Windows Restore Problems	292
34.12	Windows Ownership and Permissions Problems	292
34.13	Manually resetting the Permissions	292
34.14	Backing Up the WinNT/XP/2K System State	294
34.15	Fixing the Windows Boot Record	295
34.16	Considerations for Filename Specifications	295
34.17	Windows Specific File daemon Command Line	295
34.18	Shutting down Windows Systems	296
35	Disaster Recovery Using Bacula	297
35.1	General	297
35.2	Important Considerations	297
35.3	Steps to Take Before Disaster Strikes	297
35.4	Bare Metal Recovery on Linux with a Rescue CD	298
35.5	Requirements	298
35.6	Restoring a Client System	298
35.7	Boot with your Rescue CDROM	299
35.8	Restoring a Server	300
35.9	Linux Problems or Bugs	301
35.10	Bare Metal Recovery using a LiveCD	301
35.11	FreeBSD Bare Metal Recovery	302
35.12	Solaris Bare Metal Recovery	303
35.13	Preparing Solaris Before a Disaster	303
35.14	Bugs and Other Considerations	303
35.15	Disaster Recovery of Win32 Systems	304
35.16	Ownership and Permissions on Win32 Systems	304
35.17	Alternate Disaster Recovery Suggestion for Win32 Systems	304



- 35.18 Restoring to a Running System 305
- 35.19 Additional Resources 305
- 36 Bacula TLS – Communications Encryption 307**
- 36.1 TLS Configuration Directives 307
- 36.2 Creating a Self-signed Certificate 308
- 36.3 Getting a CA Signed Certificate 308
- 36.4 Example TLS Configuration Files 309
- 37 Data Encryption 311**
- 37.1 Building Bacula with Encryption Support 311
- 37.2 Encryption Technical Details 312
- 37.3 Decrypting with a Master Key 312
- 37.4 Generating Private/Public Encryption Keys 312
- 37.5 Example Data Encryption Configuration 313
- 38 Using Bacula to Improve Computer Security 315**
- 38.1 The Details 315
- 38.2 Running the Verify 316
- 38.3 What To Do When Differences Are Found 317
- 38.4 A Verify Configuration Example 318
- 39 Installing and Configuring MySQL 321**
- 39.1 Installing and Configuring MySQL – Phase I 321
- 39.2 Installing and Configuring MySQL – Phase II 322
- 39.3 Re-initializing the Catalog Database 323
- 39.4 Linking Bacula with MySQL 323
- 39.5 Installing MySQL from RPMs 323
- 39.6 Upgrading MySQL 323
- 40 Installing and Configuring PostgreSQL 325**
- 40.1 Installing PostgreSQL 325
- 40.2 Configuring PostgreSQL 326
- 40.3 Re-initializing the Catalog Database 328
- 40.4 Installing PostgreSQL from RPMs 328
- 40.5 Converting from MySQL to PostgreSQL 328
- 40.6 Upgrading PostgreSQL 330
- 40.7 Tuning PostgreSQL 330
- 40.8 Credits 330
- 41 Installing and Configuring SQLite 331**
- 41.1 Installing and Configuring SQLite – Phase I 331
- 41.2 Installing and Configuring SQLite – Phase II 332
- 41.3 Linking Bacula with SQLite 332
- 41.4 Testing SQLite 332
- 41.5 Re-initializing the Catalog Database 332
- 42 Catalog Maintenance 333**
- 42.1 Setting Retention Periods 333
- 42.2 Compacting Your MySQL Database 334
- 42.3 Repairing Your MySQL Database 334
- 42.4 MySQL Table is Full 335
- 42.5 MySQL Server Has Gone Away 335
- 42.6 MySQL Temporary Tables 335
- 42.7 Repairing Your PostgreSQL Database 336
- 42.8 Database Performance Issues 336
- 42.9 Performance Issues Indexes 336
 - 42.9.1 PostgreSQL Indexes 336
 - 42.9.2 MySQL Indexes 337
 - 42.9.3 SQLite Indexes 337
- 42.10 Compacting Your PostgreSQL Database 337



42.11	Compacting Your SQLite Database	338
42.12	Migrating from SQLite to MySQL or PostgreSQL	338
42.13	Backing Up Your Bacula Database	338
42.14	Security considerations	339
42.15	Backing Up Third Party Databases	339
42.16	Database Size	339
43	Bacula Security Issues	341
43.1	Backward Compatibility	341
43.2	Configuring and Testing TCP Wrappers	342
43.3	Running as non-root	343
44	The Bootstrap File	345
44.1	Bootstrap File Format	345
44.2	Automatic Generation of Bootstrap Files	348
44.3	Bootstrap for bscan	348
44.4	A Final Bootstrap Example	348
45	Bacula Copyright, Trademark, and Licenses	351
45.1	CC-BY-SA	351
45.2	GPL	351
45.3	LGPL	351
45.4	Public Domain	351
45.5	Trademark	351
45.6	Fiduciary License Agreement	351
45.7	Disclaimer	352
45.8	Authors	352
45.9	Table of Contents	364
45.10	GNU LESSER GENERAL PUBLIC LICENSE	364
45.11	Preamble	364
45.12	TERMS AND CONDITIONS	365
45.13	How to Apply These Terms to Your New Libraries	369
46	Thanks	371
46.1	Bacula Bugs	373



Chapter 1

What is Bacula?

Bacula is a set of computer programs that permits the system administrator to manage backup, recovery, and verification of computer data across a network of computers of different kinds. Bacula can also run entirely upon a single computer and can backup to various types of media, including tape and disk.

In technical terms, it is a network Client/Server based backup program. Bacula is relatively easy to use and efficient, while offering many advanced storage management features that make it easy to find and recover lost or damaged files. Due to its modular design, Bacula is scalable from small single computer systems to systems consisting of hundreds of computers located over a large network.

1.1 Who Needs Bacula?

If you are currently using a program such as tar, dump, or bru to backup your computer data, and you would like a network solution, more flexibility, or catalog services, Bacula will most likely provide the additional features you want. However, if you are new to Unix systems or do not have offsetting experience with a sophisticated backup package, the Bacula project does not recommend using Bacula as it is much more difficult to setup and use than tar or dump.

If you want Bacula to behave like the above mentioned simple programs and write over any tape that you put in the drive, then you will find working with Bacula difficult. Bacula is designed to protect your data following the rules you specify, and this means reusing a tape only as the last resort. It is possible to "force" Bacula to write over any tape in the drive, but it is easier and more efficient to use a simpler program for that kind of operation.

If you would like a backup program that can write to multiple volumes (i.e. is not limited by your tape drive capacity), Bacula can most likely fill your needs. In addition, quite a number of Bacula users report that Bacula is simpler to setup and use than other equivalent programs.

If you are currently using a sophisticated commercial package such as Legato Networker, ARCserveIT, Arkeia, or PerfectBackup+, you may be interested in Bacula, which provides many of the same features and is free software available under the Affero GPL Version 3 software license.

1.2 Bacula Components or Services

Bacula is made up of the following five major components or services: Director, Console, File, Storage, and Monitor services.

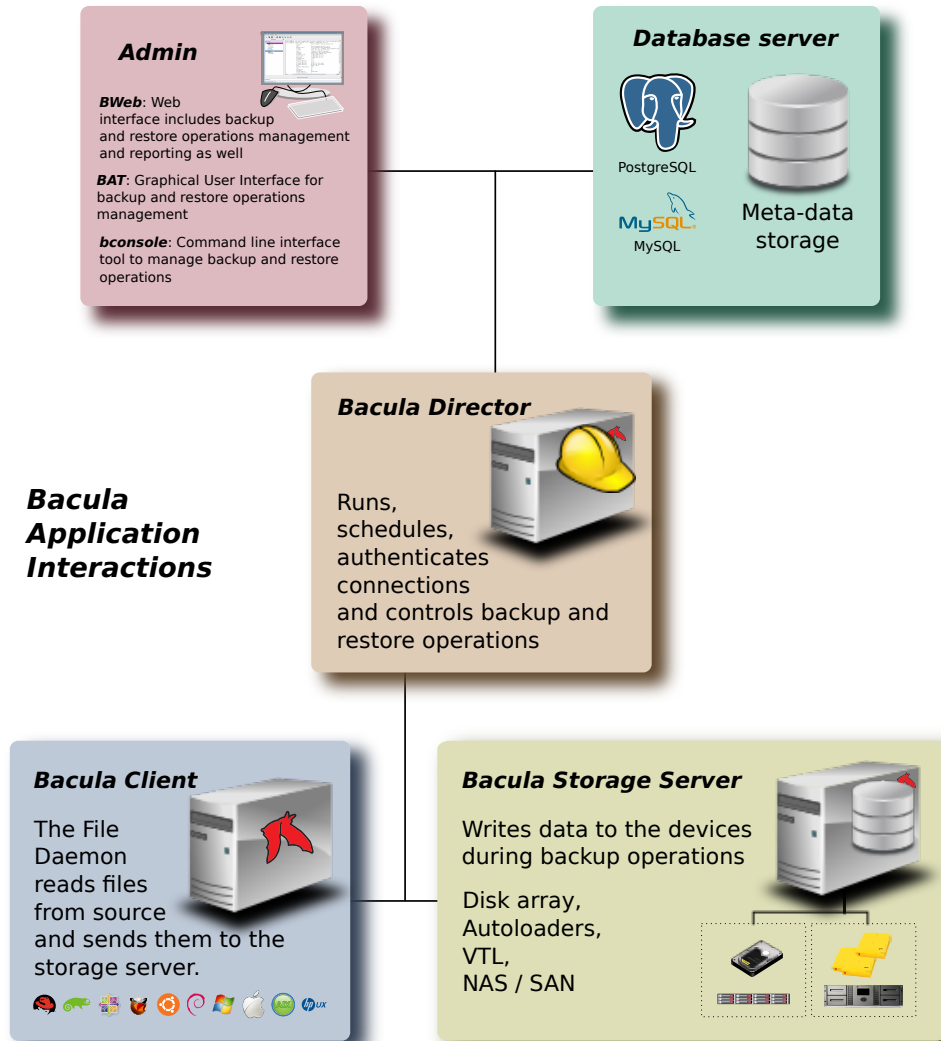

(thanks to Aristedes Maniatis for this graphic and the one below)

Bacula Director

The Bacula Director service is the program that supervises all the backup, restore, verify and archive operations. The system administrator uses the Bacula Director to schedule backups and to recover files. For more details see the Director Services Daemon Design Document in the Bacula Developer’s Guide. The Director runs as a daemon (or service) in the background.

Bacula Console

The Bacula Console service is the program that allows the administrator or user to communicate with the Bacula Director. Currently, the Bacula Console is available in three versions: text-based console interface, QT-based interface, and a wxWidgets graphical interface. The first and simplest is to run the Console program in a shell window (i.e. TTY interface). Most system administrators will find this completely adequate. The second version is a GNOME GUI interface that is far from complete, but quite functional as it has most the capabilities of the shell Console. The third version is a wxWidgets GUI with an interactive file restore. It also has most of the capabilities of the shell console, allows command completion with tabulation, and gives you instant help about the command you are typing. For more details see the **Bacula Console Design Document** (Chapter 1 on the preceding page) .

Bacula File

The Bacula File service (also known as the Client program) is the software program that is installed on the machine to be backed up. It is specific to the operating system on which it runs and is responsible for



providing the file attributes and data when requested by the Director. The File services are also responsible for the file system dependent part of restoring the file attributes and data during a recovery operation. For more details see the File Services Daemon Design Document in the Bacula Developer's Guide. This program runs as a daemon on the machine to be backed up. In addition to Unix/Linux File daemons, there is a Windows File daemon (normally distributed in binary format). The Windows File daemon runs on current Windows versions (NT, 2000, XP, 2003, and possibly Me and 98).

Bacula Storage

The Bacula Storage services consist of the software programs that perform the storage and recovery of the file attributes and data to the physical backup media or volumes. In other words, the Storage daemon is responsible for reading and writing your tapes (or other storage media, e.g. files). For more details see the Storage Services Daemon Design Document in the Bacula Developer's Guide. The Storage services runs as a daemon on the machine that has the backup device (usually a tape drive).

Catalog

The Catalog services are comprised of the software programs responsible for maintaining the file indexes and volume databases for all files backed up. The Catalog services permit the system administrator or user to quickly locate and restore any desired file. The Catalog services sets Bacula apart from simple backup programs like tar and bru, because the catalog maintains a record of all Volumes used, all Jobs run, and all Files saved, permitting efficient restoration and Volume management. Bacula currently supports three different databases, MySQL, PostgreSQL, and SQLite, one of which must be chosen when building Bacula.

The three SQL databases currently supported (MySQL, PostgreSQL or SQLite) provide quite a number of features, including rapid indexing, arbitrary queries, and security. Although the Bacula project plans to support other major SQL databases, the current Bacula implementation interfaces only to MySQL, PostgreSQL and SQLite. For the technical and porting details see the Catalog Services Design Document in the developer's documented.

The packages for MySQL and PostgreSQL are available for several operating systems. Alternatively, installing from the source is quite easy, see the Installing and Configuring MySQL chapter of this document for the details. For more information on MySQL, please see: www.mysql.com . Or see the Installing and Configuring PostgreSQL chapter of this document for the details. For more information on PostgreSQL, please see: www.postgresql.org .

Configuring and building SQLite is even easier. For the details of configuring SQLite, please see the Installing and Configuring SQLite chapter of this document.

Bacula Monitor

A Bacula Monitor service is the program that allows the administrator or user to watch current status of Bacula Directors, Bacula File Daemons and Bacula Storage Daemons. Currently, only a GTK+ version is available, which works with GNOME, KDE, or any window manager that supports the FreeDesktop.org system tray standard.

To perform a successful save or restore, the following four daemons must be configured and running: the Director daemon, the File daemon, the Storage daemon, and the Catalog service (MySQL, PostgreSQL or SQLite).

1.3 Bacula Configuration

In order for Bacula to understand your system, what clients you want backed up and how, you must create a number of configuration files containing resources (or objects). The following presents an overall picture of this:

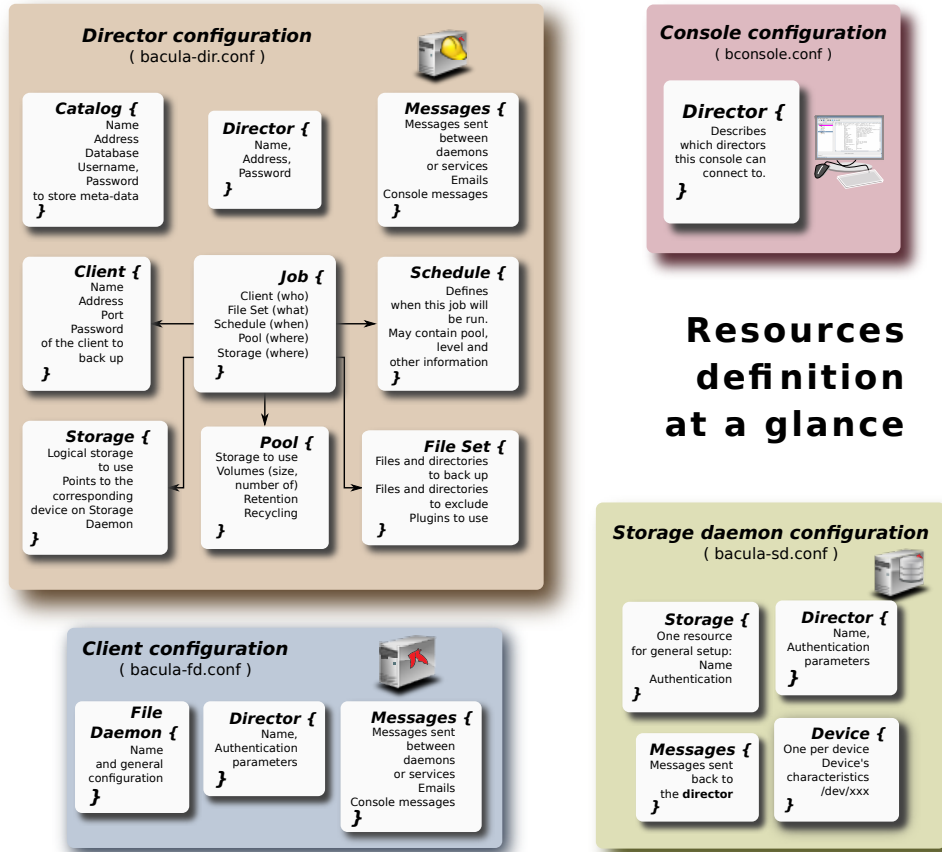

1.4 Conventions Used in this Document

Bacula is in a state of evolution, and as a consequence, this manual will not always agree with the code. If an item in this manual is preceded by an asterisk (*), it indicates that the particular feature is not implemented. If it is preceded by a plus sign (+), it indicates that the feature may be partially implemented. If you are reading this manual as supplied in a released version of the software, the above paragraph holds true. If you are reading the online version of the manual, www.bacula.org, please bear in mind that this version describes the current version in development (in the CVS) that may contain features not in the released version. Just the same, it generally lags behind the code a bit.

1.5 Quick Start

To get Bacula up and running quickly, the author recommends that you first scan the Terminology section below, then quickly review the next chapter entitled The Current State of Bacula, then the Getting Started with Bacula, which will give you a quick overview of getting Bacula running. After which, you should proceed to the chapter on Installing Bacula, then How to Configure Bacula, and finally the chapter on Running Bacula.

1.6 Terminology

Administrator The person or persons responsible for administrating the Bacula system.

Backup The term Backup refers to a Bacula Job that saves files.

Bootstrap File The bootstrap file is an ASCII file containing a compact form of commands that allow Bacula or the stand-alone file extraction utility (bextract) to restore the contents of one or more Volumes, for example, the current state of a system just backed up. With a bootstrap file, Bacula can restore your system without a Catalog. You can create a bootstrap file from a Catalog to extract any file or files you wish.

Catalog The Catalog is used to store summary information about the Jobs, Clients, and Files that were backed up and on what Volume or Volumes. The information saved in the Catalog permits the administrator or user to determine what jobs were run, their status as well as the important characteristics of each file that was backed up, and most importantly, it permits you to choose what files to restore. The Catalog is an online resource, but does not contain the data for the files backed up. Most of the information stored in the catalog is also stored on the backup volumes (i.e. tapes). Of course, the tapes will also have a copy of the file data in addition to the File Attributes (see below).

The catalog feature is one part of Bacula that distinguishes it from simple backup and archive programs such as dump and tar.

Client In Bacula's terminology, the word Client refers to the machine being backed up, and it is synonymous with the File services or File daemon, and quite often, it is referred to it as the FD. A Client is defined in a configuration file resource.

Console The program that interfaces to the Director allowing the user or system administrator to control Bacula.

Daemon Unix terminology for a program that is always present in the background to carry out a designated task. On Windows systems, as well as some Unix systems, daemons are called Services.

Directive The term directive is used to refer to a statement or a record within a Resource in a configuration file that defines one specific setting. For example, the **Name** directive defines the name of the Resource.

Director The main Bacula server daemon that schedules and directs all Bacula operations. Occasionally, the project refers to the Director as DIR.

Differential A backup that includes all files changed since the last Full save started. Note, other backup programs may define this differently.

File Attributes The File Attributes are all the information necessary about a file to identify it and all its properties such as size, creation date, modification date, permissions, etc. Normally, the attributes are handled entirely by Bacula so that the user never needs to be concerned about them. The attributes do not include the file's data.

File Daemon The daemon running on the client computer to be backed up. This is also referred to as the File services, and sometimes as the Client services or the FD.

FileSet A FileSet is a Resource contained in a configuration file that defines the files to be backed up. It consists of a list of included files or directories, a list of excluded files, and how the file is to be stored (compression, encryption, signatures). For more details, see the FileSet Resource definition in the Director chapter of this document.

Incremental A backup that includes all files changed since the last Full, Differential, or Incremental backup started. It is normally specified on the **Level** directive within the Job resource definition, or in a Schedule resource.

Job A Bacula Job is a configuration resource that defines the work that Bacula must perform to backup or restore a particular Client. It consists of the **Type** (backup, restore, verify, etc), the **Level** (full, incremental,...), the **FileSet**, and **Storage** the files are to be backed up (Storage device, Media Pool). For more details, see the Job Resource definition in the Director chapter of this document.

Monitor The program that interfaces to all the daemons allowing the user or system administrator to monitor Bacula status.

Resource A resource is a part of a configuration file that defines a specific unit of information that is available to Bacula. It consists of several directives (individual configuration statements). For example, the **Job** resource defines all the properties of a specific Job: name, schedule, Volume pool, backup type, backup level, ...

Restore A restore is a configuration resource that describes the operation of recovering a file from backup media. It is the inverse of a save, except that in most cases, a restore will normally have a small set of files to restore, while normally a Save backs up all the files on the system. Of course, after a disk crash, Bacula can be called upon to do a full Restore of all files that were on the system.



Schedule A Schedule is a configuration resource that defines when the Bacula Job will be scheduled for execution. To use the Schedule, the Job resource will refer to the name of the Schedule. For more details, see the Schedule Resource definition in the Director chapter of this document.

Service This is a program that remains permanently in memory awaiting instructions. In Unix environments, services are also known as **daemons**.

Storage Coordinates The information returned from the Storage Services that uniquely locates a file on a backup medium. It consists of two parts: one part pertains to each file saved, and the other part pertains to the whole Job. Normally, this information is saved in the Catalog so that the user doesn't need specific knowledge of the Storage Coordinates. The Storage Coordinates include the File Attributes (see above) plus the unique location of the information on the backup Volume.

Storage Daemon The Storage daemon, sometimes referred to as the SD, is the code that writes the attributes and data to a storage Volume (usually a tape or disk).

Session Normally refers to the internal conversation between the File daemon and the Storage daemon. The File daemon opens a **session** with the Storage daemon to save a FileSet or to restore it. A session has a one-to-one correspondence to a Bacula Job (see above).

Verify A verify is a job that compares the current file attributes to the attributes that have previously been stored in the Bacula Catalog. This feature can be used for detecting changes to critical system files similar to what a file integrity checker like Tripwire does. One of the major advantages of using Bacula to do this is that on the machine you want protected such as a server, you can run just the File daemon, and the Director, Storage daemon, and Catalog reside on a different machine. As a consequence, if your server is ever compromised, it is unlikely that your verification database will be tampered with.

Verify can also be used to check that the most recent Job data written to a Volume agrees with what is stored in the Catalog (i.e. it compares the file attributes), *or it can check the Volume contents against the original files on disk.

***Archive** An Archive operation is done after a Save, and it consists of removing the Volumes on which data is saved from active use. These Volumes are marked as Archived, and may no longer be used to save files. All the files contained on an Archived Volume are removed from the Catalog. NOT YET IMPLEMENTED.

Retention Period There are various kinds of retention periods that Bacula recognizes. The most important are the **File** Retention Period, **Job** Retention Period, and the **Volume** Retention Period. Each of these retention periods applies to the time that specific records will be kept in the Catalog database. This should not be confused with the time that the data saved to a Volume is valid.

The File Retention Period determines the time that File records are kept in the catalog database. This period is important for two reasons: the first is that as long as File records remain in the database, you can "browse" the database with a console program and restore any individual file. Once the File records are removed or pruned from the database, the individual files of a backup job can no longer be "browsed". The second reason for carefully choosing the File Retention Period is because the volume of the database File records use the most storage space in the database. As a consequence, you must ensure that regular "pruning" of the database file records is done to keep your database from growing too large. (See the Console **prune** command for more details on this subject).

The Job Retention Period is the length of time that Job records will be kept in the database. Note, all the File records are tied to the Job that saved those files. The File records can be purged leaving the Job records. In this case, information will be available about the jobs that ran, but not the details of the files that were backed up. Normally, when a Job record is purged, all its File records will also be purged.

The Volume Retention Period is the minimum of time that a Volume will be kept before it is reused. Bacula will normally never overwrite a Volume that contains the only backup copy of a file. Under ideal conditions, the Catalog would retain entries for all files backed up for all current Volumes. Once a Volume is overwritten, the files that were backed up on that Volume are automatically removed from the Catalog. However, if there is a very large pool of Volumes or a Volume is never overwritten, the Catalog database may become enormous. To keep the Catalog to a manageable size, the backup information should be removed from the Catalog after the defined File Retention Period. Bacula provides the mechanisms for the catalog to be automatically pruned according to the retention periods defined.



Scan A Scan operation causes the contents of a Volume or a series of Volumes to be scanned. These Volumes with the information on which files they contain are restored to the Bacula Catalog. Once the information is restored to the Catalog, the files contained on those Volumes may be easily restored. This function is particularly useful if certain Volumes or Jobs have exceeded their retention period and have been pruned or purged from the Catalog. Scanning data from Volumes into the Catalog is done by using the **bscan** program. See the **bscan** section (section 1.7 on the next page) of the Bacula Community Utility programs for more details.

Volume A Volume is an archive unit, normally a tape or a named disk file where Bacula stores the data from one or more backup jobs. All Bacula Volumes have a software label written to the Volume by Bacula so that it identifies what Volume it is really reading. (Normally there should be no confusion with disk files, but with tapes, it is easy to mount the wrong one.)

1.7 What Bacula is Not

Bacula is a backup, restore and verification program and is not a complete disaster recovery system in itself, but it can be a key part of one if you plan carefully and follow the instructions included in the Disaster Recovery Chapter of this manual.

With proper planning, as mentioned in the Disaster Recovery chapter, Bacula can be a central component of your disaster recovery system. For example, if you have created an emergency boot disk, and/or a Bacula Rescue disk to save the current partitioning information of your hard disk, and maintain a complete Bacula backup, it is possible to completely recover your system from "bare metal" that is starting from an empty disk.

If you have used the **WriteBootstrap** record in your job or some other means to save a valid bootstrap file, you will be able to use it to extract the necessary files (without using the catalog or manually searching for the files to restore).

1.8 Interactions Between the Bacula Services

The following block diagram shows the typical interactions between the Bacula Services for a backup job. Each block represents in general a separate process (normally a daemon). In general, the Director oversees the flow of information. It also maintains the Catalog.

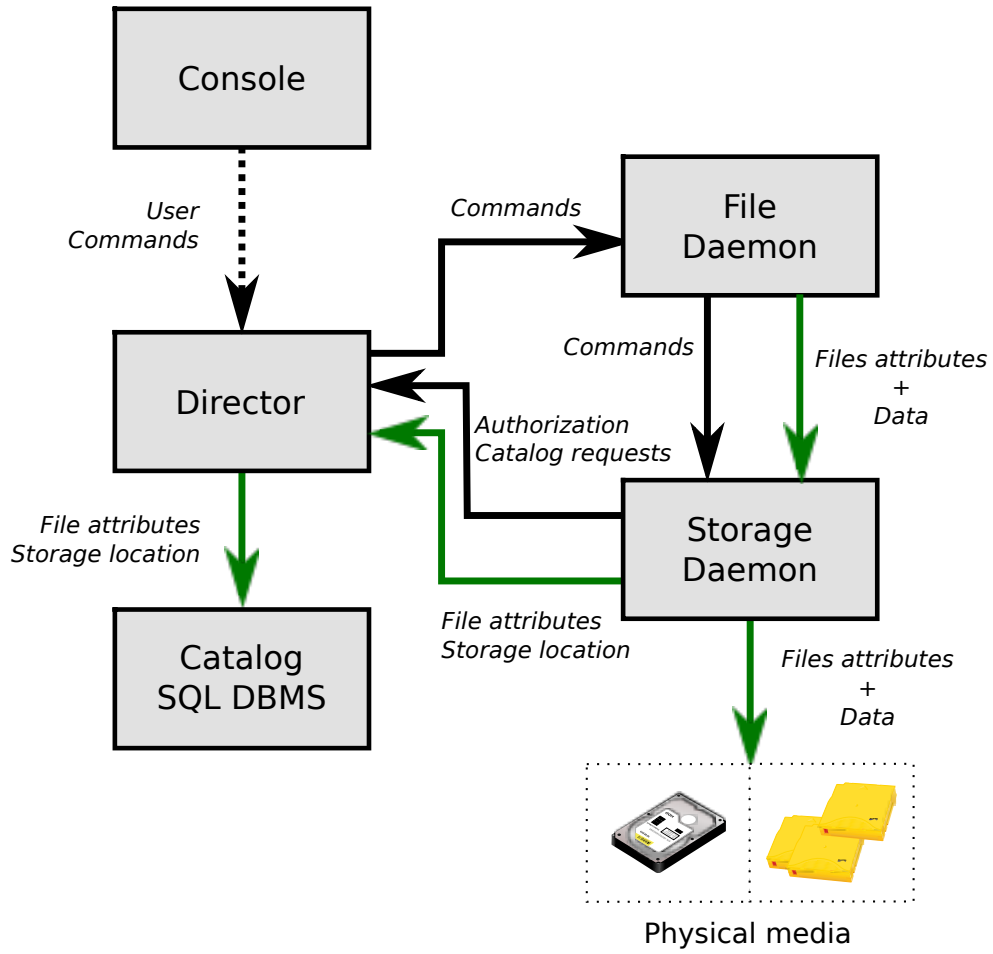



Chapter 2

New Features in 7.0.0

This chapter presents the new features that have been added to the various versions of Bacula.

2.1 New Features in 7.0.0

2.1.1 Storage daemon to Storage daemon

Bacula version 7.0 permits SD to SD transfer of Copy and Migration Jobs. This permits what is commonly referred to as replication or off-site transfer of Bacula backups. It occurs automatically, if the source SD and destination SD of a Copy or Migration job are different. The following picture shows how this works.

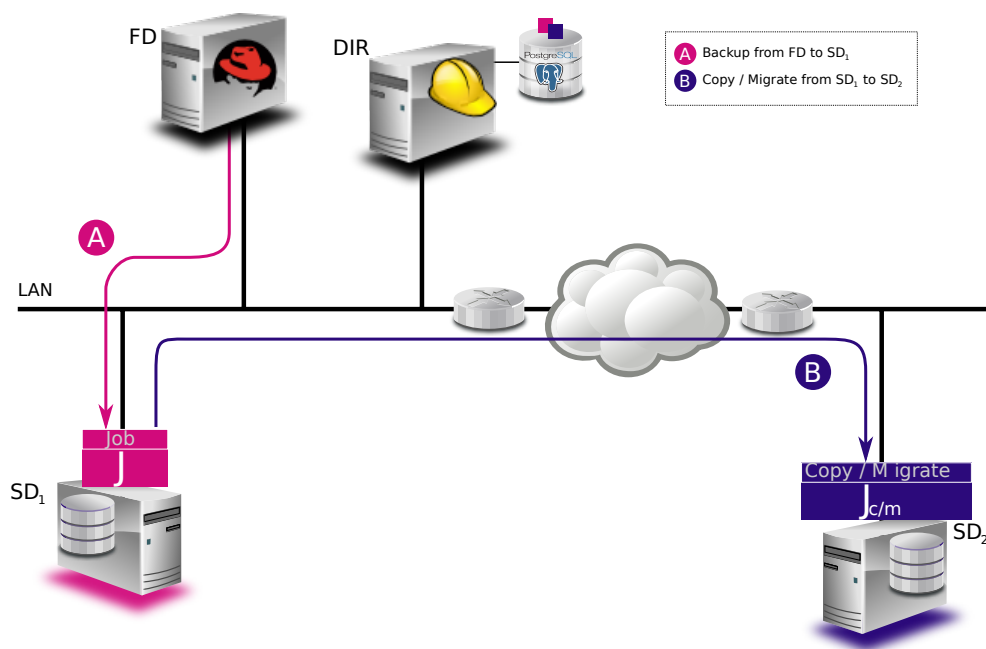

2.1.2 SD Calls Client

If the **SD Calls Client** directive is set to true in a Client resource any Backup, Restore, Verify, Copy, or Migration Job where the client is involved, the client will wait for the Storage daemon to contact it. By default this directive is set to false, and the Client will call the Storage daemon. This directive can be useful if your Storage daemon is behind a firewall that permits outgoing connections but not incoming one. The following picture shows the communications connection paths in both cases.



Default Connection Sequence

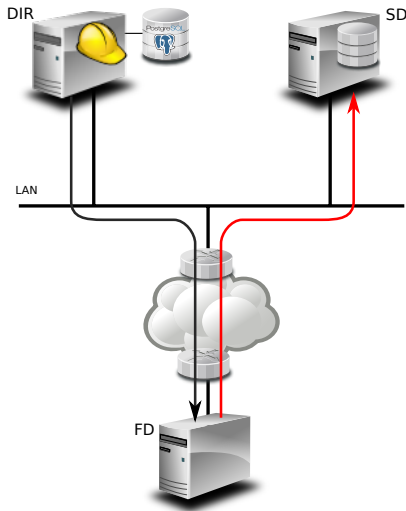

Connection Sequence with SD Calls Client directive

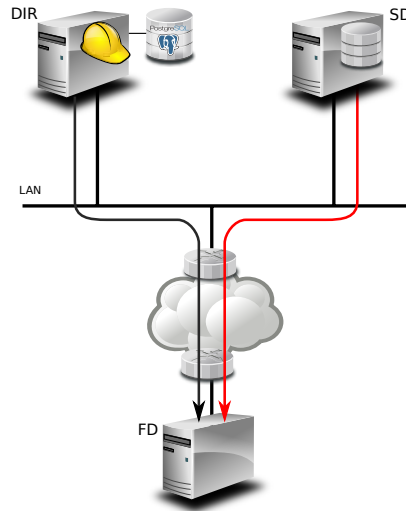

2.1.3 Next Pool

In previous versions of Bacula the Next Pool directive could be specified in the Pool resource for use with Migration and Copy Jobs. The Next Pool concept has been extended in Bacula version 7.0.0 to allow you to specify the Next Pool directive in the Job resource as well. If specified in the Job resource, it will override any value specified in the Pool resource.

In addition to being permitted in the Job resource, the **nextpool=xxx** specification can be specified as a run override in the **run** directive of a Schedule resource. Any **nextpool** specification in a **run** directive will override any other specification in either the Job or the Pool.

In general, more information is displayed in the Job log on exactly which Next Pool specification is ultimately used.

2.1.4 status storage

The bconsole **status storage** has been modified to attempt to eliminate duplicate storage resources and only show one that references any given storage daemon. This might be confusing at first, but tends to make a much more compact list of storage resource from which to select if there are multiple storage devices in the same storage daemon.

If you want the old behavior (always display all storage resources) simply add the keyword **select** to the command – i.e. use **status select storage**.

2.1.5 status schedule

A new status command option called **scheduled** has been implemented in bconsole. By default it will display 20 lines of the next scheduled jobs. For example, with the default bacula-dir.conf configuration file, a bconsole command **status scheduled** produces:

Scheduled Jobs:

Level	Type	Pri	Scheduled	Job Name	Schedule
Differential	Backup	10	Sun 30-Mar 23:05	BackupClient1	WeeklyCycle
Incremental	Backup	10	Mon 24-Mar 23:05	BackupClient1	WeeklyCycle
Incremental	Backup	10	Tue 25-Mar 23:05	BackupClient1	WeeklyCycle
...					
Full	Backup	11	Mon 24-Mar 23:10	BackupCatalog	WeeklyCycleAfterBackup
Full	Backup	11	Wed 26-Mar 23:10	BackupCatalog	WeeklyCycleAfterBackup
...					



Note, the output is listed by the Jobs found, and is not sorted chronologically.

This command has a number of options, most of which act as filters:

- **days=nn** This specifies the number of days to list. The default is 10 but can be set from 0 to 500.
- **limit=nn** This specifies the limit to the number of lines to print. The default is 100 but can be any number in the range 0 to 2000.
- **time="YYYY-MM-DD HH:MM:SS"** Sets the start time for listing the scheduled jobs. The default is to use the current time. Note, the time value must be specified inside double quotes and must be in the exact form shown above.
- **schedule=schedule-name** This option restricts the output to the named schedule.
- **job=job-name** This option restricts the output to the specified Job name.

2.1.6 Data Encryption Cipher Configuration

Bacula version 7.0 and later now allows to configure the data encryption cipher and the digest algorithm. The cipher was forced to AES 128, and it is now possible to choose between the following ciphers:

- AES128 (default)
- AES192
- AES256
- blowfish

The digest algorithm was set to SHA1 or SHA256 depending on the local OpenSSL options. We advise you to not modify the PkiDigest default setting. Please, refer to OpenSSL documentation to know about pro and cons on these options.

```
FileDaemon {
    ...
    PkiCipher = AES256
}
```

2.1.7 New Truncate Command

We have added a new truncate command to bconsole, which will truncate a Volume if the Volume is purged and if the Volume is also marked **Action On Purge = Truncate**. This feature was originally added in Bacula version 5.0.1, but the mechanism for actually doing the truncate required the user to enter a command such as:

```
purge volume action=truncate storage=File pool=Default
```

The above command is now simplified to be:

```
truncate storage=File pool=Default
```

2.1.8 Migration/Copy/VirtualFull Performance Enhancements

The Bacula Storage daemon now permits multiple jobs to simultaneously read the same disk Volume, which gives substantial performance enhancements when running Migration, Copy, or VirtualFull jobs that read disk Volumes. Our testing shows that when running multiple simultaneous jobs, the jobs can finish up to ten times faster with this version of Bacula. This is built-in to the Storage daemon, so it happens automatically and transparently.



2.1.9 VirtualFull Backup Consolidation Enhancements

By default Bacula selects jobs automatically for a VirtualFull, however, you may want to create the Virtual backup based on a particular backup (point in time) that exists.

For example, if you have the following backup Jobs in your catalog:

JobId	Name	Level	JobFiles	JobBytes	JobStatus
1	Vbackup	F	1754	50118554	T
2	Vbackup	I	1	4	T
3	Vbackup	I	1	4	T
4	Vbackup	D	2	8	T
5	Vbackup	I	1	6	T
6	Vbackup	I	10	60	T
7	Vbackup	I	11	65	T
8	Save	F	1758	50118564	T

and you want to consolidate only the first 3 jobs and create a virtual backup equivalent to Job 1 + Job 2 + Job 3, you will use `jobid=3` in the `run` command, then Bacula will select the previous Full backup, the previous Differential (if any) and all subsequent Incremental jobs.

```
run job=Vbackup jobid=3 level=VirtualFull
```

If you want to consolidate a specific job list, you must specify the exact list of jobs to merge in the run command line. For example, to consolidate the last Differential and all subsequent Incremental, you will use `jobid=4,5,6,7` or `jobid=4-7` on the run command line. As one of the Job in the list is a Differential backup, Bacula will set the new job level to Differential. If the list is composed only with Incremental jobs, the new job will have a level set to Incremental.

```
run job=Vbackup jobid=4-7 level=VirtualFull
```

When using this feature, Bacula will automatically discard jobs that are not related to the current Job. For example, specifying `jobid=7,8`, Bacula will discard JobId 8 because it is not part of the same backup Job.

We do not recommend it, but really want to consolidate jobs that have different names (so probably different clients, filesets, etc...), you must use `alljobid=` keyword instead of `jobid=`.

```
run job=Vbackup alljobid=1-3,6-8 level=VirtualFull
```

2.1.10 FD Storage Address

When the Director is behind a NAT, in a WAN area, to connect to the StorageDaemon, the Director uses an “external” ip address, and the FileDaemon should use an “internal” IP address to contact the StorageDaemon.

The normal way to handle this situation is to use a canonical name such as “storage-server” that will be resolved on the Director side as the WAN address and on the Client side as the LAN address. This is now possible to configure this parameter using the new directive `FDStorageAddress` in the Storage or Client resource.

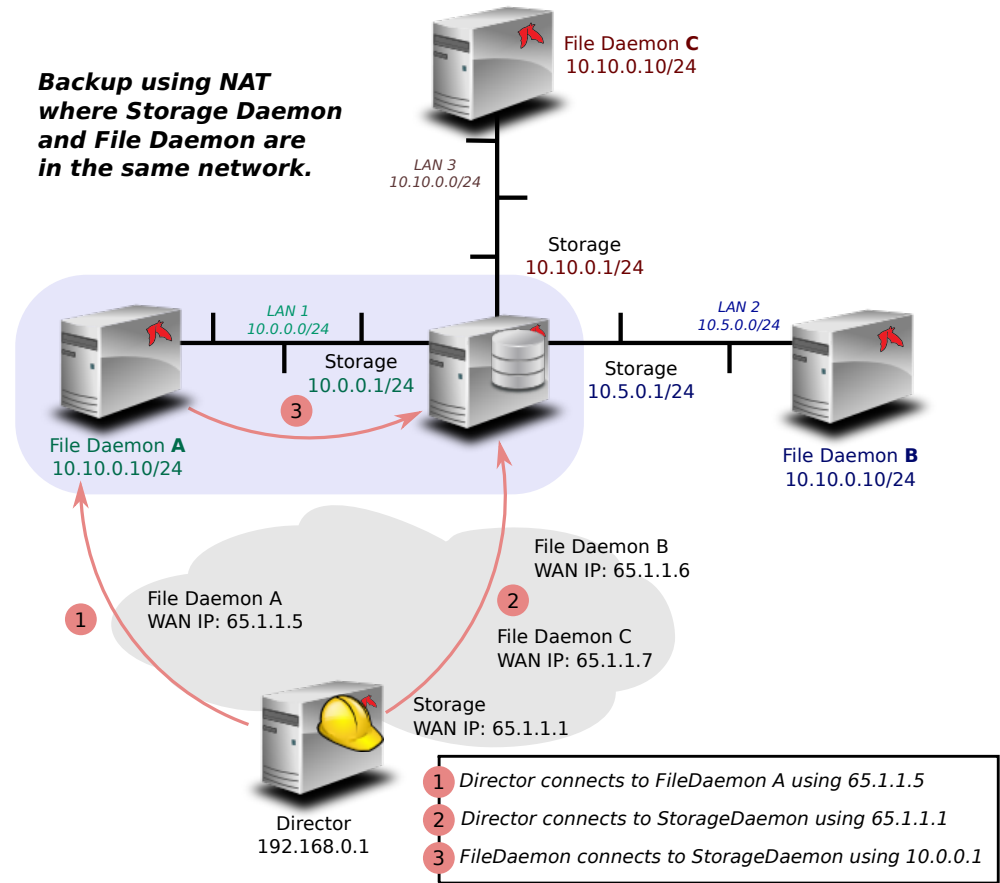

```
Storage {
    Name = storage1
    Address = 65.1.1.1
    FD Storage Address = 10.0.0.1
    SD Port = 9103
    ...
}

Client {
    Name = client1
    Address = 65.1.1.2
    FD Storage Address = 10.0.0.1
    FD Port = 9102
    ...
}
```

Note that using the Client `FDStorageAddress` directive will not allow to use multiple Storage Daemon, all Backup or Restore requests will be sent to the specified `FDStorageAddress`.

2.1.11 Job Bandwidth Limitation

The new **Job Bandwidth Limitation** directive may be added to the File daemon's and/or Director's configuration to limit the bandwidth used by a Job on a Client. It can be set in the File daemon's conf file for all Jobs run in that File daemon, or it can be set for each Job in the Director's conf file. The speed is always specified in bytes per second.

For example:

```
FileDaemon {
    Name = localhost-fd
    Working Directory = /some/path
    Pid Directory = /some/path
    ...
}
```



```
Maximum Bandwidth Per Job = 5Mb/s
}
```

The above example would cause any jobs running with the FileDaemon to not exceed 5 megabytes per second of throughput when sending data to the Storage Daemon. Note, the speed is always specified in bytes per second (not in bits per second), and the case (upper/lower) of the specification characters is ignored (i.e. 1MB/s = 1Mb/s).

You may specify the following speed parameter modifiers: k/s (1,000 bytes per second), kb/s (1,024 bytes per second), m/s (1,000,000 bytes per second), or mb/s (1,048,576 bytes per second).

For example:

```
Job {
  Name = localhost-data
  FileSet = FS_localhost
  Accurate = yes
  ...
  Maximum Bandwidth = 5Mb/s
  ...
}
```

The above example would cause Job `localhost-data` to not exceed 5MB/s of throughput when sending data from the File daemon to the Storage daemon.

A new console command `setbandwidth` permits to set dynamically the maximum throughput of a running Job or for future jobs of a Client.

```
* setbandwidth limit=1000 jobid=10
```

Please note that the value specified for the `limit` command line parameter is always in units of 1024 bytes (i.e. the number is multiplied by 1024 to give the number of bytes per second). As a consequence, the above limit of 1000 will be interpreted as a limit of $1000 * 1024 = 1,024,000$ bytes per second.

This project was funded by Bacula Systems.

2.1.12 Maximum Concurrent Read Jobs

This is a new directive that can be used in the `bacula-dir.conf` file in the Storage resource. The main purpose is to limit the number of concurrent Copy, Migration, and VirtualFull jobs so that they don't monopolize all the Storage drives causing a deadlock situation where all the drives are allocated for reading but none remain for writing. This deadlock situation can occur when running multiple simultaneous Copy, Migration, and VirtualFull jobs.

The default value is set to 0 (zero), which means there is no limit on the number of read jobs. Note, limiting the read jobs does not apply to Restore jobs, which are normally started by hand. A reasonable value for this directive is one half the number of drives that the Storage resource has rounded down. Doing so, will leave the same number of drives for writing and will generally avoid over committing drives and a deadlock.

2.1.13 Director job Codes in Message Resource Commands

Before submitting the specified mail command to the operating system, Bacula performs character substitution like in Runscript commands. Bacula will now perform also specific Director character substitution.

The code for this feature was contributed by Bastian Friedrich.

2.1.14 Additions to RunScript variables

The following variables are now available in runscripts:

- current PID using `%P`
- if the job is a clone job using `%C`

```
RunAfterJob = "/bin/echo Pid=%P isCloned=%C"
```

2.1.15 Read Only Storage Devices

This version of Bacula permits defining a Storage daemon device to be read-only. That is if the **ReadOnly** directive is specified and enabled, the drive can only be used for read operations. The the **ReadOnly** directive can be defined in any bacula-sd.conf Device resource, and is most useful to reserve one or more drives for restores. An example is:

```
Read Only = yes
```

2.1.16 New Prune “Expired” Volume Command

It is now possible to prune all volumes (from a pool, or globally) that are “expired”. This option can be scheduled after or before the backup of the Catalog and can be combined with the Truncate On Purge option. The Expired Prune option can be used instead of the `manual_prune.pl` script.

```
* prune expired volumes
* prune expired volumes pool=FullPool
```

To schedule this option automatically, it can be added to the BackupCatalog job definition.

```
Job {
  Name = CatalogBackup
  ...
  RunScript {
    Console = "prune expired volume yes"
    RunsWhen = Before
  }
}
```

2.1.17 Hardlink Performance Enhancements

If you use a program such as Cyrus IMAP that creates very large numbers of hardlinks, the time to build the interactive restore tree can be excessively long. This version of Bacula has a new feature that automatically keeps the hardlinks associated with the restore tree in memory, which consumes a bit more memory but vastly speeds up building the tree. If the memory usage is too big for your system, you can reduce the amount of memory used during the restore command by adding the option **optimizespeed=false** on the `bconsole` run command line.

This feature was developed by Josip Almasi, and enhanced to be runtime dynamic by Kern Sibbald.

2.1.18 DisableCommand Directive

There is a new Directive named **Disable Command** that can be put in the File daemon Client or Director resource. If it is in the Client, it applies globally, otherwise the directive applies only to the Director in which it is found. The Disable Command adds security to your File daemon by disabling certain commands. The commands that can be disabled are:

```
backup
cancel
setdebug=
setbandwidth=
estimate
fileset
JobId=
level =
restore
endrestore
session
status
.status
storage
verify
```



RunBeforeNow
RunBeforeJob
RunAfterJob
Run
accurate

On or more of these command keywords can be placed in quotes and separated by spaces on the Disable Command directive line. Note: the commands must be written exactly as they appear above.

2.1.19 Multiple Console Directors

Support for multiple bconsole and bat Directors in the bconsole.conf and bat.conf files has been implemented and/or improved.

2.1.20 Restricted Consoles

Better support for Restricted consoles has been implement for bconsole and bat.

2.1.21 Configuration Files

In previous versions of Bacula the configuration files for each component were limited to a maximum of 499 bytes per configuration file line. This version of Bacula permits unlimited input line lengths. This can be especially useful for specifying more complicated Migration/Copy SQL statements and in creating long restricted console ACL lists.

2.1.22 Maximum Spawned Jobs

The Job resource now permits specifying a number of **Maximum Spawn Jobs**. The default is 300. This directive can be useful if you have big hardware and you do a lot of Migration/Copy jobs which start at the same time. In prior versions of Bacula, Migration/Copy was limited to spawning a maximum of 100 jobs at a time.

2.1.23 Progress Meter

The new File daemon has been enhanced to send its progress (files processed and bytes written) to the Director every 30 seconds. These figures can then be displayed with a bconsole **status dir** command.

2.1.24 Scheduling a 6th Week

Prior version of Bacula permits specifying 1st through 5th week of a month (first through fifth) as a keyword on the **run** directive of a Schedule resource. This version of Bacula also permits specifying the 6th week of a month with the keyword **sixth** or **6th**.

2.1.25 Scheduling the Last Day of a Month

This version of Bacula now permits specifying the **lastday** keyword in the **run** directive of a Schedule resource. If **lastday** is specified, it will apply only to those months specified on the **run** directive. Note: by default all months are specified.

2.1.26 Improvements to Cancel and Restart bconsole Commands

The Restart bconsole command now allow selection of either canceled or failed jobs to be restarted. In addition both the **cancel** and **restart** bconsole commands permit entering a number of JobIds separated by commas or a range of JobIds indicated by a dash between the begin and end range (e.g. 3-10). Finally the two commands also allow one to enter the special keyword **all** to select all the appropriate Jobs.

2.1.27 bconsole Performance Improvements

In previous versions of Bacula certain bconsole commands could wait a long time due to catalog lock contention. This was especially noticeable when a large number of jobs were running and putting their attributes into the catalog. This version uses a separate catalog connection that should significantly enhance performance.

2.1.28 New .bvfs_decode_lstat Command

There is a new bconsole command, which is `.bvfs_decode_lstat` it requires one argument, which is `lstat="lstat value to decode"`. An example command in bconsole and the output might be:

```
.bvfs_decode_lstat lstat="A A Eht B A A A JP BAA B BTL/A7 BTL/A7 BTL/A7 A A C"

st_nlink=1
st_mode=16877
st_uid=0
st_gid=0
st_size=591
st_blocks=1
st_ino=0
st_ctime=1395650619
st_mtime=1395650619
st_mtime=1395650619
st_dev=0
LinkFI=0
```

New Debug Options

In Bacula Enterprise version 8.0 and later, we introduced new options to the `setdebug` command. If the `options` parameter is set, the following arguments can be used to control debug functions.

- 0 clear debug flags
- i Turn off, ignore `bwrite()` errors on restore on File Daemon
- d Turn off decomp of `BackupRead()` streams on File Daemon
- t Turn on timestamp in traces
- T Turn off timestamp in traces
- c Truncate trace file if trace file is activated
- l Turn on recoding events on `P()` and `V()`
- p Turn on the display of the event ring when doing a backtrace

The following command will truncate the trace file and will turn on timestamps in the trace file.

```
* setdebug level=10 trace=1 options=ct fd
```

It is now possible to use `class` of debug messages called `tags` to control the debug output of Bacula daemons.

- all Display all debug messages
- bvfs Display BVFS debug messages
- sql Display SQL related debug messages

memory Display memory and poolmem allocation messages

scheduler Display scheduler related debug messages

```
* setdebug level=10 tags=bvfs,sql,memory
* setdebug level=10 tags=!bvfs
```

```
# bacula-dir -t -d 200,bvfs,sql
```

The `tags` option is composed of a list of tags, tags are separated by “,” or “+” or “-” or “!”. To disable a specific tag, use “-” or “!” in front of the tag. Note that more tags will come in future versions.





Chapter 3

New Features in 5.2.13

This chapter presents the new features that have been added to the current Community version of Bacula that is now released.

3.0.1 Additions to RunScript variables

You can have access to Director name using %D in your runscript command.

```
RunAfterJob = "/bin/echo Director=%D"
```

3.1 New Features in 5.2.1

This chapter presents the new features were added in the Community release version 5.2.1. There are additional features (plugins) available in the Enterprise version that are described in another chapter. A subscription to Bacula Systems is required for the Enterprise version.

3.1.1 LZO Compression

LZO compression has been to the File daemon. From the user's point of view, it works like the GZIP compression (just replace **compression=GZIP** with **compression=LZO**).

For example:

```
Include {  
    Options {compression=LZO }  
    File = /home  
    File = /data  
}
```

LZO provides a much faster compression and decompression speed but lower compression ratio than GZIP. It is a good option when you backup to disk. For tape, the hardware compression is almost always a better option.

LZO is a good alternative for GZIP1 when you don't want to slow down your backup. With a modern CPU it should be able to run almost as fast as:

- your client can read data from disk. Unless you have very fast disks like SSD or large/fast RAID array.
- the data transfers between the file daemon and the storage daemon even on a 1Gb/s link.

Note, Bacula uses compression level LZO1X-1.

The code for this feature was contributed by Laurent Papier.

3.1.2 New Tray Monitor

Since the old integrated Windows tray monitor doesn't work with recent Windows versions, we have written a new Qt Tray Monitor that is available for both Linux and Windows. In addition to all the previous features, this new version allows you to run Backups from the tray monitor menu.

To be able to run a job from the tray monitor, you need to allow specific commands in the Director monitor console:

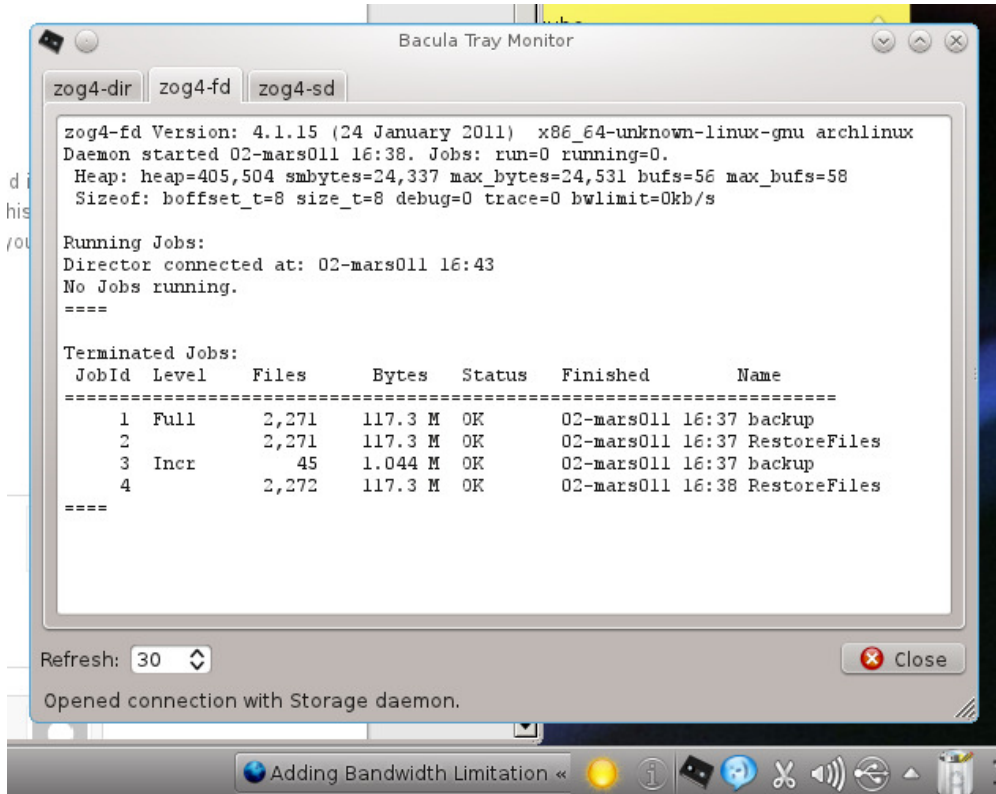

Figure 3.1: New tray monitor

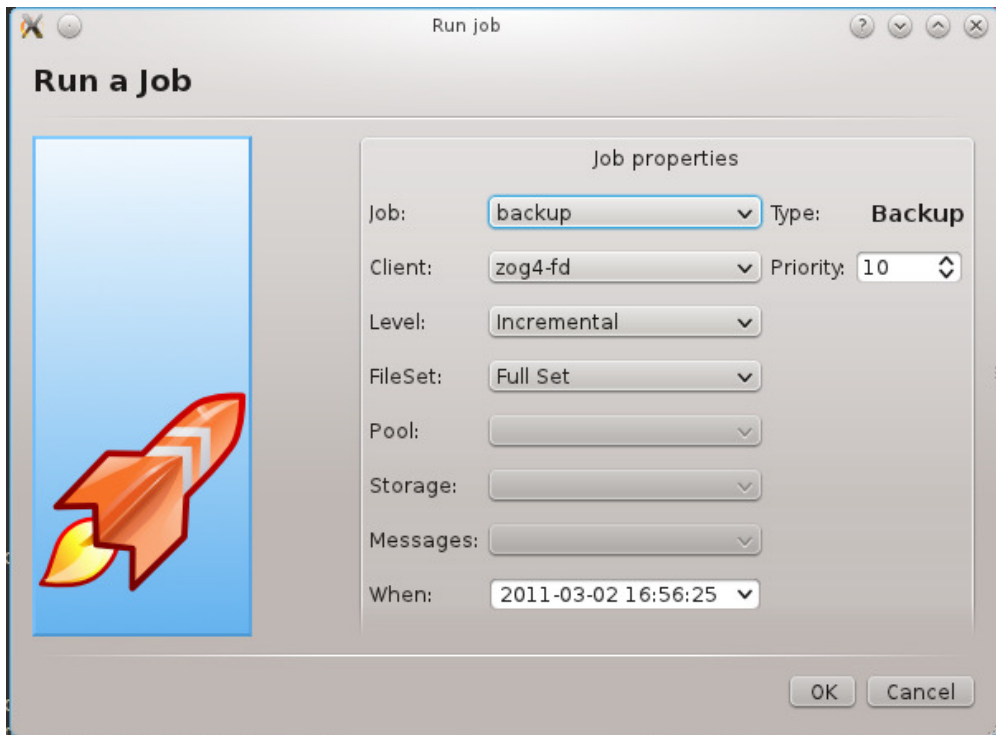

Figure 3.2: Run a Job through the new tray monitor

```

Console {
  Name = win2003-mon
  Password = "xxx"
  CommandACL = status, .clients, .jobs, .pools, .storage, .filesets, .messages, run
  ClientACL = *all*           # you can restrict to a specific host
  CatalogACL = *all*
  JobACL = *all*
  StorageACL = *all*
  ScheduleACL = *all*
  PoolACL = *all*
  FileSetACL = *all*
  WhereACL = *all*
}

```

This project was funded by Bacula Systems and is available with Bacula the Enterprise Edition and the Community Edition.

3.1.3 Purge Migration Job

The new **Purge Migration Job** directive may be added to the Migration Job definition in the Director's configuration file. When it is enabled the Job that was migrated during a migration will be purged at the end of the migration job.

For example:

```

Job {
  Name = "migrate-job"
  Type = Migrate
  Level = Full
  Client = localhost-fd
  FileSet = "Full Set"
  Messages = Standard
  Storage = DiskChanger
  Pool = Default
  Selection Type = Job
  Selection Pattern = ".*Save"
  ...
  Purge Migration Job = yes
}

```

This project was submitted by Dunlap Blake; testing and documentation was funded by Bacula Systems.

3.1.4 Changes in Bvfs (Bacula Virtual FileSystem)

Bat has now a bRestore panel that uses Bvfs to display files and directories.

The Bvfs module works correctly with BaseJobs, Copy and Migration jobs.

This project was funded by Bacula Systems.

General notes

- All fields are separated by a tab
- You can specify `limit=` and `offset=` to list smoothly records in very big directories
- All operations (except cache creation) are designed to run instantly
- At this time, Bvfs works faster on PostgreSQL than MySQL catalog. If you can contribute new faster SQL queries we will be happy, else don't complain about speed.
- The cache creation is dependent of the number of directories. As Bvfs shares information across jobs, the first creation can be slow
- All fields are separated by a tab
- Due to potential encoding problem, it's advised to always use `pathid` in queries.

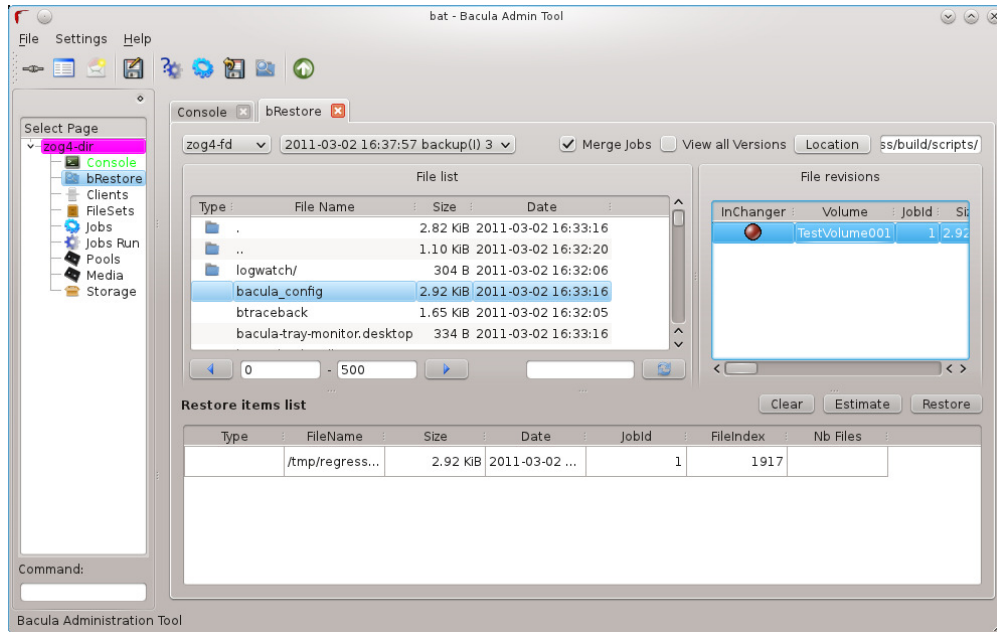

Figure 3.3: Bat BRestore Panel

Get dependent jobs from a given JobId

Bvfs allows you to query the catalog against any combination of jobs. You can combine all Jobs and all FileSet for a Client in a single session.

To get all JobId needed to restore a particular job, you can use the `.bvfs_get_jobids` command.

```
.bvfs_get_jobids jobid=num [all]

.bvfs_get_jobids jobid=10
1,2,5,10
.bvfs_get_jobids jobid=10 all
1,2,3,5,10
```

In this example, a normal restore will need to use JobIds 1,2,5,10 to compute a complete restore of the system.

With the `all` option, the Director will use all defined FileSet for this client.

Generating Bvfs cache

The `.bvfs_update` command computes the directory cache for jobs specified in argument, or for all jobs if unspecified.

```
.bvfs_update [jobid=numlist]
```

Example:

```
.bvfs_update jobid=1,2,3
```

You can run the cache update process in a RunScript after the catalog backup.

Get all versions of a specific file

Bvfs allows you to find all versions of a specific file for a given Client with the `.bvfs_version` command. To avoid problems with encoding, this function uses only PathId and FileNameId. The jobid argument is mandatory but unused.

```
.bvfs_versions client=filedaemon pathid=num filenameid=num jobid=1
PathId FileNameId FileId JobId LStat Md5 VolName Inchanger
PathId FileNameId FileId JobId LStat Md5 VolName Inchanger
...
```



Example:

```
.bvfs_versions client=localhost-fd pathid=1 fnid=47 jobid=1
1 47 52 12 gD HRid IGk D Po Po A P BAA I A /uPgWaxMgKZlnMti7LChyA Vol1 1
```

List directories

Bvfs allows you to list directories in a specific path.

```
.bvfs_lsdirs pathid=num path=/apath jobid=numlist limit=num offset=num
PathId FilenameId FileId JobId LStat Path
PathId FilenameId FileId JobId LStat Path
PathId FilenameId FileId JobId LStat Path
...
```

You need to pathid or path. Using path="" will list "/" on Unix and all drives on Windows. If FilenameId is 0, the record listed is a directory.

```
.bvfs_lsdirs pathid=4 jobid=1,11,12
4 0 0 0 A A A A A A A A A A A A A A .
5 0 0 0 A A A A A A A A A A A A A A ..
3 0 0 0 A A A A A A A A A A A A A A regress/
```

In this example, to list directories present in regress/, you can use

```
.bvfs_lsdirs pathid=3 jobid=1,11,12
3 0 0 0 A A A A A A A A A A A A A A .
4 0 0 0 A A A A A A A A A A A A A A ..
2 0 0 0 A A A A A A A A A A A A A A tmp/
```

List files

Bvfs allows you to list files in a specific path.

```
.bvfs_lsfiles pathid=num path=/apath jobid=numlist limit=num offset=num
PathId FilenameId FileId JobId LStat Path
PathId FilenameId FileId JobId LStat Path
PathId FilenameId FileId JobId LStat Path
...
```

You need to pathid or path. Using path="" will list "/" on Unix and all drives on Windows. If FilenameId is 0, the record listed is a directory.

```
.bvfs_lsfiles pathid=4 jobid=1,11,12
4 0 0 0 A A A A A A A A A A A A A A .
5 0 0 0 A A A A A A A A A A A A A A ..
1 0 0 0 A A A A A A A A A A A A A A regress/
```

In this example, to list files present in regress/, you can use

```
.bvfs_lsfiles pathid=1 jobid=1,11,12
1 47 52 12 gD HRid IGk BAA I BMqcPH BMqcPE BMqe+t A titi
1 49 53 12 gD HRid IGk BAA I BMqe/K BMqcPE BMqe+t B toto
1 48 54 12 gD HRie IGk BAA I BMqcPH BMqcPE BMqe+3 A tutu
1 45 55 12 gD HRid IGk BAA I BMqe/K BMqcPE BMqe+t B fichero1.txt
1 46 56 12 gD HRie IGk BAA I BMqe/K BMqcPE BMqe+3 D fichero2.txt
```

Restore set of files

Bvfs allows you to create a SQL table that contains files that you want to restore. This table can be provided to a restore command with the file option.

```
.bvfs_restore fileid=numlist dirid=numlist hardlink=numlist path=b2num
OK
restore file=?b2num ...
```



To include a directory (with `dirid`), `Bvfs` needs to run a query to select all files. This query could be time consuming.

`hardlink` list is always composed of a series of two numbers (jobid, fileindex). This information can be found in the `LinkFI` field of the `LStat` packet.

The `path` argument represents the name of the table that `Bvfs` will store results. The format of this table is `b2[0-9]+`. (Should start by `b2` and followed by digits).

Example:

```
.bvfs_restore fileid=1,2,3,4 hardlink=10,15,10,20 jobid=10 path=b20001
OK
```

Cleanup after Restore

To drop the table used by the restore command, you can use the `.bvfs_cleanup` command.

```
.bvfs_cleanup path=b20001
```

Clearing the BVFS Cache

To clear the BVFS cache, you can use the `.bvfs_clear_cache` command.

```
.bvfs_clear_cache yes
OK
```

3.1.5 Changes in the Pruning Algorithm

We rewrote the job pruning algorithm in this version. Previously, in some users reported that the pruning process at the end of jobs was very long. It should not be longer the case. Now, Bacula won't prune automatically a Job if this particular Job is needed to restore data. Example:

```
JobId: 1 Level: Full
JobId: 2 Level: Incremental
JobId: 3 Level: Incremental
JobId: 4 Level: Differential
.. Other incrementals up to now
```

In this example, if the Job Retention defined in the Pool or in the Client resource causes that Jobs with Jobid in 1,2,3,4 can be pruned, Bacula will detect that JobId 1 and 4 are essential to restore data at the current state and will prune only JobId 2 and 3.

Important, this change affect only the automatic pruning step after a Job and the `prune jobs Bconsole` command. If a volume expires after the `VolumeRetention` period, important jobs can be pruned.

3.1.6 Ability to Verify any specified Job

You now have the ability to tell Bacula which Job should verify instead of automatically verify just the last one.

This feature can be used with `VolumeToCatalog`, `DiskToCatalog` and `Catalog` level.

To verify a given job, just specify the Job jobid in argument when starting the job.

```
*run job=VerifyVolume jobid=1 level=VolumeToCatalog
Run Verify job
JobName:    VerifyVolume
Level:      VolumeToCatalog
Client:     127.0.0.1-fd
FileSet:    Full Set
Pool:       Default (From Job resource)
Storage:    File (From Job resource)
Verify Job: VerifyVol.2010-09-08_14.17.17_03
Verify List: /tmp/regress/working/VerifyVol.bsr
When:       2010-09-08 14:17:31
Priority:    10
OK to run? (yes/mod/no):
```

This project was funded by Bacula Systems and is available with Bacula Enterprise Edition and Community Edition.



3.1.7 Additions to RunScript variables

You can have access to JobBytes and JobFiles using %b and %F in your runscript command. The Client address is now available through %h.

```
RunAfterJob = "/bin/echo Job=%j JobBytes=%b JobFiles=%F ClientAddress=%h"
```

3.1.8 Additions to the Plugin API

The bfuncs structure has been extended to include a number of new entrypoints.

bfuncs

The bFuncs structure defines the callback entry points within Bacula that the plugin can use register events, get Bacula values, set Bacula values, and send messages to the Job output or debug output.

The exact definition as of this writing is:

```
typedef struct s_baculaFuncs {
    uint32_t size;
    uint32_t version;
    bRC (*registerBaculaEvents)(bpContext *ctx, ...);
    bRC (*getBaculaValue)(bpContext *ctx, bVariable var, void *value);
    bRC (*setBaculaValue)(bpContext *ctx, bVariable var, void *value);
    bRC (*JobMessage)(bpContext *ctx, const char *file, int line,
        int type, utime_t mtime, const char *fmt, ...);
    bRC (*DebugMessage)(bpContext *ctx, const char *file, int line,
        int level, const char *fmt, ...);
    void *(*baculaMalloc)(bpContext *ctx, const char *file, int line,
        size_t size);
    void (*baculaFree)(bpContext *ctx, const char *file, int line, void *mem);

    /* New functions follow */
    bRC (*AddExclude)(bpContext *ctx, const char *file);
    bRC (*AddInclude)(bpContext *ctx, const char *file);
    bRC (*AddIncludeOptions)(bpContext *ctx, const char *opts);
    bRC (*AddRegex)(bpContext *ctx, const char *item, int type);
    bRC (*AddWild)(bpContext *ctx, const char *item, int type);
    bRC (*checkChanges)(bpContext *ctx, struct save_pkt *sp);
} bFuncs;
```

AddExclude can be called to exclude a file. The file string passed may include wildcards that will be interpreted by the **fnmatch** subroutine. This function can be called multiple times, and each time the file specified will be added to the list of files to be excluded. Note, this function only permits adding excludes of specific file or directory names, or files matched by the rather simple fnmatch mechanism. See below for information on doing wild-card and regex excludes.

NewPreInclude can be called to create a new Include block. This block will be added after the current defined Include block. This function can be called multiple times, but each time, it will create a new Include section (not normally needed). This function should be called only if you want to add an entirely new Include block.

NewInclude can be called to create a new Include block. This block will be added before any user defined Include blocks. This function can be called multiple times, but each time, it will create a new Include section (not normally needed). This function should be called only if you want to add an entirely new Include block.

AddInclude can be called to add new files/directories to be included. They are added to the current Include block. If NewInclude has not been included, the current Include block is the last one that the user created. This function should be used only if you want to add totally new files/directories to be included in the backup.



NewOptions adds a new Options block to the current Include in front of any other Options blocks. This permits the plugin to add exclude directives (wild-cards and regexes) in front of the user Options, and thus prevent certain files from being backed up. This can be useful if the plugin backs up files, and they should not be also backed up by the main Bacula code. This function may be called multiple times, and each time, it creates a new prepended Options block. Note: normally you want to call this entry point prior to calling AddOptions, AddRegex, or AddWild.

AddOptions allows the plugin to set options in the current Options block, which is normally created with the NewOptions call just prior to adding Include Options. The permitted options are passed as a character string, where each character has a specific meaning as defined below:

- a** always replace files (default).
- e** exclude rather than include.
- h** no recursion into subdirectories.
- H** do not handle hard links.
- i** ignore case in wildcard and regex matches.
- M** compute an MD5 sum.
- p** use a portable data format on Windows (not recommended).
- R** backup resource forks and Findr Info.
- r** read from a fifo
- S1** compute an SHA1 sum.
- S2** compute an SHA256 sum.
- S3** compute an SHA512 sum.
- s** handle sparse files.
- m** use st_mtime only for file differences.
- k** restore the st_atime after accessing a file.
- A** enable ACL backup.
- Vxxx:** specify verify options. Must terminate with :
- Cxxx:** specify accurate options. Must terminate with :
- Jxxx:** specify base job Options. Must terminate with :
- Pnnn:** specify integer nnn paths to strip. Must terminate with :
- w** if newer
- Zn** specify gzip compression level n.
- K** do not use st_atime in backup decision.
- c** check if file changed during backup.
- N** honor no dump flag.
- X** enable backup of extended attributes.

AddRegex adds a regex expression to the current Options block. The following options are permitted:

- (a blank) regex applies to whole path and filename.
- F** regex applies only to the filename (directory or path stripped).
- D** regex applies only to the directory (path) part of the name.

AddWild adds a wildcard expression to the current Options block. The following options are permitted:

- (a blank) regex applies to whole path and filename.
- F** regex applies only to the filename (directory or path stripped).
- D** regex applies only to the directory (path) part of the name.

checkChanges call the `check_changes()` function in Bacula code that can use Accurate code to compare the file information in argument with the previous file information. The `delta_seq` attribute of the `save_pkt` will be updated, and the call will return `BRC_Seen` if the core code wouldn't decide to backup it.

Bacula events

The list of events has been extended to include:

```
typedef enum {
    bEventJobStart          = 1,
    bEventJobEnd            = 2,
    bEventStartBackupJob    = 3,
    bEventEndBackupJob      = 4,
    bEventStartRestoreJob   = 5,
    bEventEndRestoreJob     = 6,
    bEventStartVerifyJob    = 7,
    bEventEndVerifyJob      = 8,
    bEventBackupCommand     = 9,
    bEventRestoreCommand    = 10,
    bEventLevel             = 11,
    bEventSince             = 12,

    /* New events */
    bEventCancelCommand     = 13,
    bEventVssBackupAddComponents = 14,
    bEventVssRestoreLoadComponentMetadata = 15,
    bEventVssRestoreSetComponentsSelected = 16,
    bEventRestoreObject     = 17,
    bEventEndFileSet        = 18,
    bEventPluginCommand     = 19,
    bEventVssBeforeCloseRestore = 20,
    bEventVssPrepareSnapshot = 21
} bEventType;
```

bEventCancelCommand is called whenever the currently running Job is canceled */

bEventVssBackupAddComponents

bEventVssPrepareSnapshot is called before creating VSS snapshots, it provides a char[27] table where the plugin can add Windows drives that will be used during the Job. You need to add them without duplicates, and you can use in `fd_common.h` `add_drive()` and `copy_drives()` for this purpose.

3.1.9 ACL enhancements

The following enhancements are made to the Bacula Filed with regards to Access Control Lists (ACLs)

- Added support for AIX 5.3 and later new `aclx_get` interface which supports POSIX and NFSv4 ACLs.
- Added support for new `acl` types on FreeBSD 8.1 and later which supports POSIX and NFSv4 ACLs.
- Some generic cleanups for internal ACL handling.
- Fix for `acl` storage on OSX
- Cleanup of configure checks for ACL detection, now configure only tests for a certain interface type based on the operating system this should give less false positives on detection. Also when ACLs are detected no other `acl` checks are performed anymore.

This project was funded by Planets Communications B.V. and ELM Consultancy B.V. and is available with Bacula Enterprise Edition and Community Edition.

3.1.10 XATTR enhancements

The following enhancements are made to the Bacula Filed with regards to Extended Attributes (XATTRs)

- Added support for IRIX extended attributes using the `attr_get` interface.



- Added support for Tru64 (OSF1) extended attributes using the getproplist interface.
- Added support for AIX extended attributes available in AIX 6.x and higher using the listea/getea/setea interface.
- Added some debugging to generic xattr code so it easier to debug.
- Cleanup of configure checks for XATTR detection, now configure only tests for a certain interface type based on the operating system this should give less false positives on detection. Also when xattrs are detected no other xattr checks are performed anymore.

This project was funded by Planets Communications B.V. and ELM Consultancy B.V. and is available with Bacula Enterprise Edition and Community Edition.

3.1.11 Class Based Database Backend Drivers

The main Bacula Director code is independent of the SQL backend in version 5.2.0 and greater. This means that the Bacula Director can be packaged by itself, then each of the different SQL backends supported can be packaged separately. It is possible to build all the DB backends at the same time by including multiple database options at the same time.

`./configure` can be run with multiple database configure options.

```
--with-sqlite3
--with-mysql
--with-postgresql
```

Order of testing for databases is:

- postgresql
- mysql
- sqlite3

Each configured backend generates a file named: `libbaccats-<sql_backend_name>-<version>.so` A dummy catalog library is created named `libbaccats-version.so`

At configure time the first detected backend is used as the so called default backend and at install time the dummy `libbaccats-<version>.so` is replaced with the default backend type.

If you configure all three backends you get three backend libraries and the postgresql gets installed as the default.

When you want to switch to another database, first save any old catalog you may have then you can copy one of the three backend libraries over the `libbaccats-<version>.so` e.g.

An actual command, depending on your Bacula version might be:

```
cp libbaccats-postgresql-5.2.2.so libbaccats-5.2.2.so
```

where the 5.2.2 must be replaced by the Bacula release version number.

Then you must update the default backend in the following files:

```
create_bacula_database
drop_bacula_database
drop_bacula_tables
grant_bacula_privileges
make_bacula_tables
make_catalog_backup
update_bacula_tables
```

And re-run all the above scripts. Please note, this means you will have a new empty database and if you had a previous one it will be lost.

All current database backend drivers for catalog information are rewritten to use a set of multi inherited C++ classes which abstract the specific database specific internals and make sure we have a more stable generic interface with the rest of SQL code. From now on there is a strict boundary between the SQL code and the low-level database functions. This new interface should also make it easier to add a new backend for a currently unsupported database. As part of the rewrite the SQLite 2 code was removed (e.g. only SQLite

3 is now supported). An extra bonus of the new code is that you can configure multiple backends in the configure and build all backends in one compile session and select the correct database backend at install time. This should make it a lot easier for packages maintainers.

We also added cursor support for PostgreSQL backend, this improves memory usage for large installation.

This project was implemented by Planets Communications B.V. and ELM Consultancy B.V. and Bacula Systems and is available with both the Bacula Enterprise Edition and the Community Edition.

3.1.12 Hash List Enhancements

The htable hash table class has been extended with extra hash functions for handling next to char pointer hashes also 32 bits and 64 bits hash keys. Also the hash table initialization routines have been enhanced with support for passing a hint as to the number of initial pages to use for the size of the hash table. Until now the hash table always used a fixed value of 10 Mb. The private hash functions of the mountpoint entry cache have been rewritten to use the new htable class with a small memory footprint.

This project was funded by Planets Communications B.V. and ELM Consultancy B.V. and Bacula Systems and is available with Bacula Enterprise Edition and Community Edition.

3.2 Release Version 5.0.3

There are no new features in version 5.0.2. This version simply fixes a number of bugs found in version 5.0.1 during the ongoing development process.

3.3 Release Version 5.0.2

There are no new features in version 5.0.2. This version simply fixes a number of bugs found in version 5.0.1 during the ongoing development process.

3.4 New Features in 5.0.1

This chapter presents the new features that are in the released Bacula version 5.0.1. This version mainly fixes a number of bugs found in version 5.0.0 during the ongoing development process.

3.4.1 Truncate Volume after Purge

The Pool directive **ActionOnPurge=Truncate** instructs Bacula to truncate the volume when it is purged with the new command `purge volume action`. It is useful to prevent disk based volumes from consuming too much space.

```
Pool {
  Name = Default
  Action On Purge = Truncate
  ...
}
```

As usual you can also set this property with the `update volume` command

```
*update volume=xxx ActionOnPurge=Truncate
*update volume=xxx actiononpurge=None
```

To ask Bacula to truncate your Purged volumes, you need to use the following command in interactive mode or in a RunScript as shown after:

```
*purge volume action=truncate storage=File allpools
# or by default, action=all
*purge volume action storage=File pool=Default
```

This is possible to specify the volume name, the media type, the pool, the storage, etc... (see `help purge`) Be sure that your storage device is idle when you decide to run this command.



```
Job {
  Name = CatalogBackup
  ...
  RunScript {
    RunsWhen=After
    RunsOnClient=No
    Console = "purge volume action=all allpools storage=File"
  }
}
```

Important note: This feature doesn't work as expected in version 5.0.0. Please do not use it before version 5.0.1.

3.4.2 Allow Higher Duplicates

This directive did not work correctly and has been deprecated (disabled) in version 5.0.1. Please remove it from your bacula-dir.conf file as it will be removed in a future release.

3.4.3 Cancel Lower Level Duplicates

This directive was added in Bacula version 5.0.1. It compares the level of a new backup job to old jobs of the same name, if any, and will kill the job which has a lower level than the other one. If the levels are the same (i.e. both are Full backups), then nothing is done and the other Cancel XXX Duplicate directives will be examined.

3.5 New Features in 5.0.0

3.5.1 Maximum Concurrent Jobs for Devices

Maximum Concurrent Jobs is a new Device directive in the Storage Daemon configuration permits setting the maximum number of Jobs that can run concurrently on a specified Device. Using this directive, it is possible to have different Jobs using multiple drives, because when the Maximum Concurrent Jobs limit is reached, the Storage Daemon will start new Jobs on any other available compatible drive. This facilitates writing to multiple drives with multiple Jobs that all use the same Pool.

This project was funded by Bacula Systems.

3.5.2 Restore from Multiple Storage Daemons

Previously, you were able to restore from multiple devices in a single Storage Daemon. Now, Bacula is able to restore from multiple Storage Daemons. For example, if your full backup runs on a Storage Daemon with an autochanger, and your incremental jobs use another Storage Daemon with lots of disks, Bacula will switch automatically from one Storage Daemon to an other within the same Restore job.

You must upgrade your File Daemon to version 3.1.3 or greater to use this feature.

This project was funded by Bacula Systems with the help of Equinet.

3.5.3 File Deduplication using Base Jobs

A base job is sort of like a Full save except that you will want the FileSet to contain only files that are unlikely to change in the future (i.e. a snapshot of most of your system after installing it). After the base job has been run, when you are doing a Full save, you specify one or more Base jobs to be used. All files that have been backed up in the Base job/jobs but not modified will then be excluded from the backup. During a restore, the Base jobs will be automatically pulled in where necessary.

This is something none of the competition does, as far as we know (except perhaps BackupPC, which is a Perl program that saves to disk only). It is big win for the user, it makes Bacula stand out as offering a unique optimization that immediately saves time and money. Basically, imagine that you have 100 nearly identical Windows or Linux machine containing the OS and user files. Now for the OS part, a Base job will be backed up once, and rather than making 100 copies of the OS, there will be only one. If one or more of the systems have some files updated, no problem, they will be automatically restored.

See the Base Job Chapter for more information.

This project was funded by Bacula Systems.



3.5.4 AllowCompression = <yes|no>

This new directive may be added to Storage resource within the Director's configuration to allow users to selectively disable the client compression for any job which writes to this storage resource.

For example:

```
Storage {
  Name = UltriumTape
  Address = ultrium-tape
  Password = storage_password # Password for Storage Daemon
  Device = Ultrium
  Media Type = LTO 3
  AllowCompression = No # Tape drive has hardware compression
}
```

The above example would cause any jobs running with the UltriumTape storage resource to run without compression from the client file daemons. This effectively overrides any compression settings defined at the FileSet level.

This feature is probably most useful if you have a tape drive which supports hardware compression. By setting the `AllowCompression = No` directive for your tape drive storage resource, you can avoid additional load on the file daemon and possibly speed up tape backups.

This project was funded by Collaborative Fusion, Inc.

3.5.5 Accurate Fileset Options

In previous versions, the accurate code used the file creation and modification times to determine if a file was modified or not. Now you can specify which attributes to use (time, size, checksum, permission, owner, group, ...), similar to the Verify options.

```
FileSet {
  Name = Full
  Include = {
    Options {
      Accurate = mcs
      Verify   = pin5
    }
    File = /
  }
}
```

i compare the inodes

p compare the permission bits

n compare the number of links

u compare the user id

g compare the group id

s compare the size

a compare the access time

m compare the modification time (st_mtime)

c compare the change time (st_ctime)

d report file size decreases

5 compare the MD5 signature

1 compare the SHA1 signature

Important note: If you decide to use checksum in Accurate jobs, the File Daemon will have to read all files even if they normally would not be saved. This increases the I/O load, but also the accuracy of the deduplication. By default, Bacula will check modification/creation time and size.

This project was funded by Bacula Systems.



3.5.6 Tab-completion for Bconsole

If you build `bconsole` with readline support, you will be able to use the new auto-completion mode. This mode supports all commands, gives help inside command, and lists resources when required. It works also in the restore mode.

To use this feature, you should have readline development package loaded on your system, and use the following option in configure.

```
./configure --with-readline=/usr/include/readline --disable-conio ...
```

The new `bconsole` won't be able to tab-complete with older directors.

This project was funded by Bacula Systems.

3.5.7 Pool File and Job Retention

We added two new Pool directives, `FileRetention` and `JobRetention`, that take precedence over Client directives of the same name. It allows you to control the Catalog pruning algorithm Pool by Pool. For example, you can decide to increase Retention times for Archive or OffSite Pool.

It seems obvious to us, but apparently not to some users, that given the definition above that the Pool File and Job Retention periods is a global override for the normal Client based pruning, which means that when the Job is pruned, the pruning will apply globally to that particular Job.

Currently, there is a bug in the implementation that causes any Pool retention periods specified to apply to **all** Pools for that particular Client. Thus we suggest that you avoid using these two directives until this implementation problem is corrected.

3.5.8 Read-only File Daemon using capabilities

This feature implements support of keeping `ReadAll` capabilities after UID/GID switch, this allows FD to keep root read but drop write permission.

It introduces new `bacula-fd` option (`-k`) specifying that `ReadAll` capabilities should be kept after UID/GID switch.

```
root@localhost:~# bacula-fd -k -u nobody -g nobody
```

The code for this feature was contributed by our friends at AltLinux.

3.5.9 Bvfs API

To help developers of restore GUI interfaces, we have added new *dot commands* that permit browsing the catalog in a very simple way.

- `.bvfs_update [jobid=x,y,z]` This command is required to update the Bvfs cache in the catalog. You need to run it before any access to the Bvfs layer.
- `.bvfs_lsdirs jobid=x,y,z path=/path | pathid=101` This command will list all directories in the specified `path` or `pathid`. Using `pathid` avoids problems with character encoding of `path/`filenames.
- `.bvfs_lsfiles jobid=x,y,z path=/path | pathid=101` This command will list all files in the specified `path` or `pathid`. Using `pathid` avoids problems with character encoding.

You can use `limit=xxx` and `offset=yyy` to limit the amount of data that will be displayed.

```
* .bvfs_update jobid=1,2
* .bvfs_update
* .bvfs_lsdir path=/ jobid=1,2
```

This project was funded by Bacula Systems.



3.5.10 Testing your Tape Drive

To determine the best configuration of your tape drive, you can run the new `speed` command available in the `btape` program.

This command can have the following arguments:

`file_size=n` Specify the Maximum File Size for this test (between 1 and 5GB). This counter is in GB.

`nb_file=n` Specify the number of file to be written. The amount of data should be greater than your memory ($file_size * nb_file$).

`skip_zero` This flag permits to skip tests with constant data.

`skip_random` This flag permits to skip tests with random data.

`skip_raw` This flag permits to skip tests with raw access.

`skip_block` This flag permits to skip tests with Bacula block access.

```
*speed file_size=3 skip_raw
btape.c:1078 Test with zero data and bacula block structure.
btape.c:956 Begin writing 3 files of 3.221 GB with blocks of 129024 bytes.
+++++
btape.c:604 Wrote 1 EOF to "Drive-0" (/dev/nst0)
btape.c:406 Volume bytes=3.221 GB. Write rate = 44.128 MB/s
...
btape.c:383 Total Volume bytes=9.664 GB. Total Write rate = 43.531 MB/s

btape.c:1090 Test with random data, should give the minimum throughput.
btape.c:956 Begin writing 3 files of 3.221 GB with blocks of 129024 bytes.
+++++
btape.c:604 Wrote 1 EOF to "Drive-0" (/dev/nst0)
btape.c:406 Volume bytes=3.221 GB. Write rate = 7.271 MB/s
+++++
...
btape.c:383 Total Volume bytes=9.664 GB. Total Write rate = 7.365 MB/s
```

When using compression, the random test will give you the minimum throughput of your drive . The test using constant string will give you the maximum speed of your hardware chain. (CPU, memory, SCSI card, cable, drive, tape).

You can change the block size in the Storage Daemon configuration file.

3.5.11 New Block Checksum Device Directive

You may now turn off the Block Checksum (CRC32) code that Bacula uses when writing blocks to a Volume. This is done by adding:

```
Block Checksum = no
```

doing so can reduce the Storage daemon CPU usage slightly. It will also permit Bacula to read a Volume that has corrupted data.

The default is **yes** – i.e. the checksum is computed on write and checked on read.

We do not recommend to turn this off particularly on older tape drives or for disk Volumes where doing so may allow corrupted data to go undetected.

3.5.12 New Bat Features

Those new features were funded by Bacula Systems.

Media List View

By clicking on “Media”, you can see the list of all your volumes. You will be able to filter by Pool, Media Type, Location,... And sort the result directly in the table. The old “Media” view is now known as “Pool”.



Volume Name	Online	Vol Bytes	Vol Usage	Vol Status	Pool	Media Type	Last Written	When expire?
BBN000L1	●	253.37 GiB	██████	Append	Default	LTO-2	2009-10-31 05:07:34	2010-10-31 05:07:34
BBN001L1	●	345.80 GiB	██████	Full	Default	LTO-2	2009-01-28 13:56:35	2010-01-28 13:56:35
BBN002L1	●	469.51 GiB	██████	Full	Default	LTO-2	2008-11-19 03:39:32	2009-11-19 03:39:32
BBN003L1	●	350.46 GiB	██████	Full	Default	LTO-2	2009-02-23 06:11:35	2010-02-23 06:11:35
BBN004L1	●	448.62 GiB	██████	Full	Default	LTO-2	2008-12-18 03:10:34	2009-12-18 03:10:34
BBN005L1	●	349.08 GiB	██████	Full	Default	LTO-2	2009-01-07 12:10:17	2010-01-07 12:10:17
BBN006L1	●	331.62 GiB	██████	Full	Default	LTO-2	2009-08-10 03:30:31	2010-08-10 03:30:31
BBN007L1	●	324.30 GiB	██████	Full	Default	LTO-2	2009-07-17 03:30:25	2010-07-17 03:30:25
BBN008L1	●	349.62 GiB	██████	Full	Default	LTO-2	2009-09-13 03:35:48	2010-09-13 03:35:48
BBN013L1	●	349.67 GiB	██████	Full	Default	LTO-2	2009-10-19 04:43:52	2010-10-19 04:43:52
BBN014L1	●	456.27 GiB	██████	Full	Default	LTO-2	2008-11-03 04:50:02	2009-11-03 04:50:02
BBN015L1	●	328.48 GiB	██████	Full	Default	LTO-2	2009-03-16 04:19:40	2010-03-16 04:19:40
BBN016L1	●	392.12 GiB	██████	Full	Default	LTO-2	2009-04-25 03:27:10	2010-04-25 03:27:10
BBN017L1	●	416.85 GiB	██████	Full	Default	LTO-2	2009-05-23 03:23:52	2010-05-23 03:23:52
BBN018L1	●	343.32 GiB	██████	Full	Default	LTO-2	2009-06-24 03:32:27	2010-06-24 03:32:27
BBN019L1	●	64.51 KiB	██████	Append	Default	LTO-2	0000-00-00 00:00:00	1971-01-01 01:00:00
GJY616L1	●	64.51 KiB	██████	Append	Default	LTO-2	0000-00-00 00:00:00	1971-01-01 01:00:00
BBN009L1	●	1 B	██████	Recycle	Default	LTO-2	2008-08-04 04:57:19	2009-08-04 04:57:19
BBN010L1	●	485.84 GiB	██████	Full	Default	LTO-2	2008-08-26 03:51:19	2009-08-26 03:51:19
BBN011L1	●	478.57 GiB	██████	Full	Default	LTO-2	2008-09-12 05:05:08	2009-09-12 05:05:08
BBN012L1	●	529.47 GiB	██████	Full	Default	LTO-2	2008-10-04 03:36:13	2009-10-04 03:36:13

Media Information View

By double-clicking on a volume (on the Media list, in the Autochanger content or in the Job information panel), you can access a detailed overview of your Volume. (cf figure 3.4 on the facing page.)

Job Information View

By double-clicking on a Job record (on the Job run list or in the Media information panel), you can access a detailed overview of your Job. (cf figure 3.5 on the next page.)

Autochanger Content View

By double-clicking on a Storage record (on the Storage list panel), you can access a detailed overview of your Autochanger. (cf figure 3.5 on the facing page.)

To use this feature, you need to use the latest mt-x-changer script version. (With new `listall` and `transfer` commands)

3.5.13 Bat on Windows

We have ported `bat` to Windows and it is now installed by default when the installer is run. It works quite well on Win32, but has not had a lot of testing there, so your feedback would be welcome. Unfortunately, even though it is installed by default, it does not yet work on 64 bit Windows operating systems.

3.5.14 New Win32 Installer

The Win32 installer has been modified in several very important ways.

- You must uninstall any current version of the Win32 File daemon before upgrading to the new one. If you forget to do so, the new installation will fail. To correct this failure, you must manually shutdown and reinstall the old File daemon.
- All files (other than menu links) are installed in `c:/Program Files/Bacula`.
- The installer no longer sets this file to require administrator privileges by default. If you want to do so, please do it manually using the `cacls` program. For example:

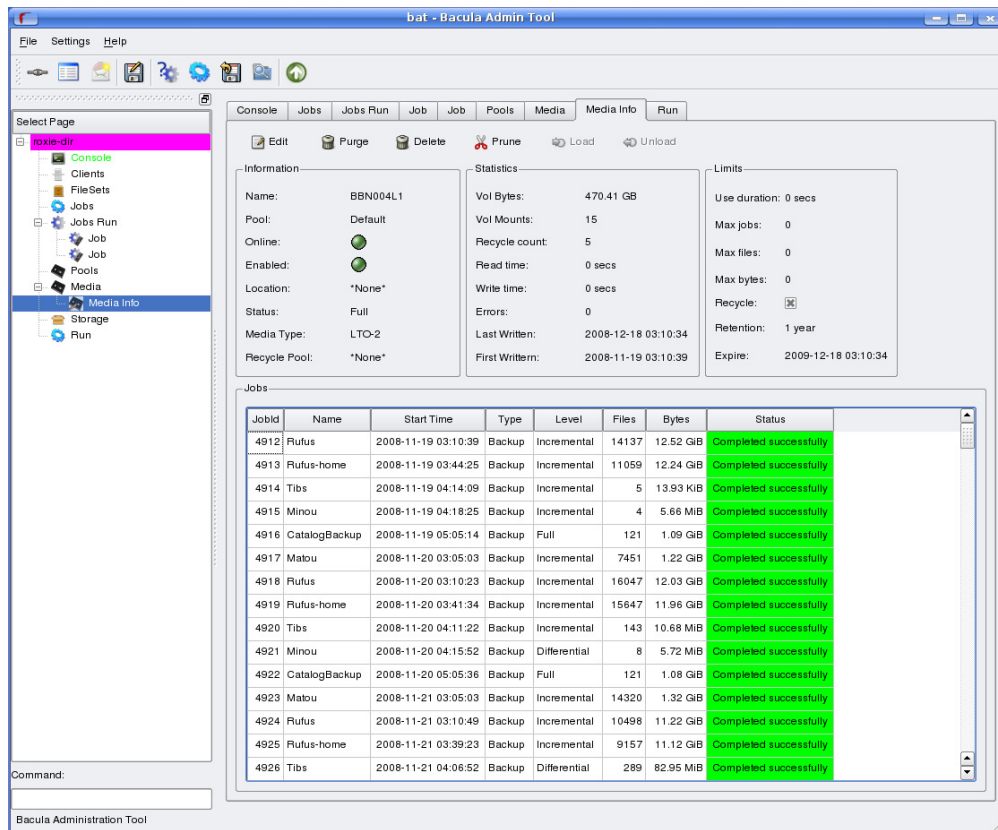

Figure 3.4: Media information

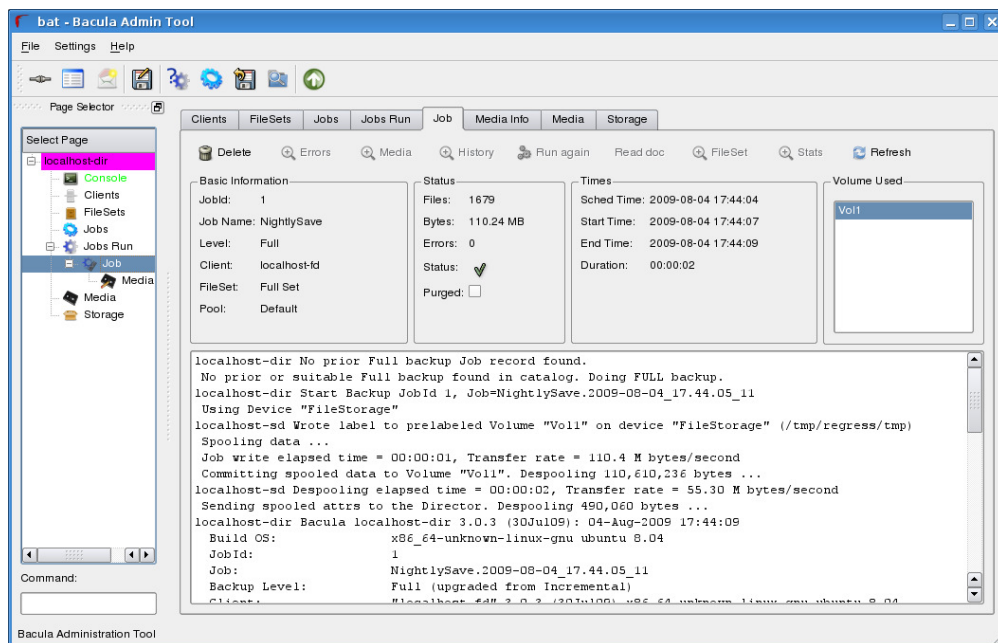

Figure 3.5: Job information

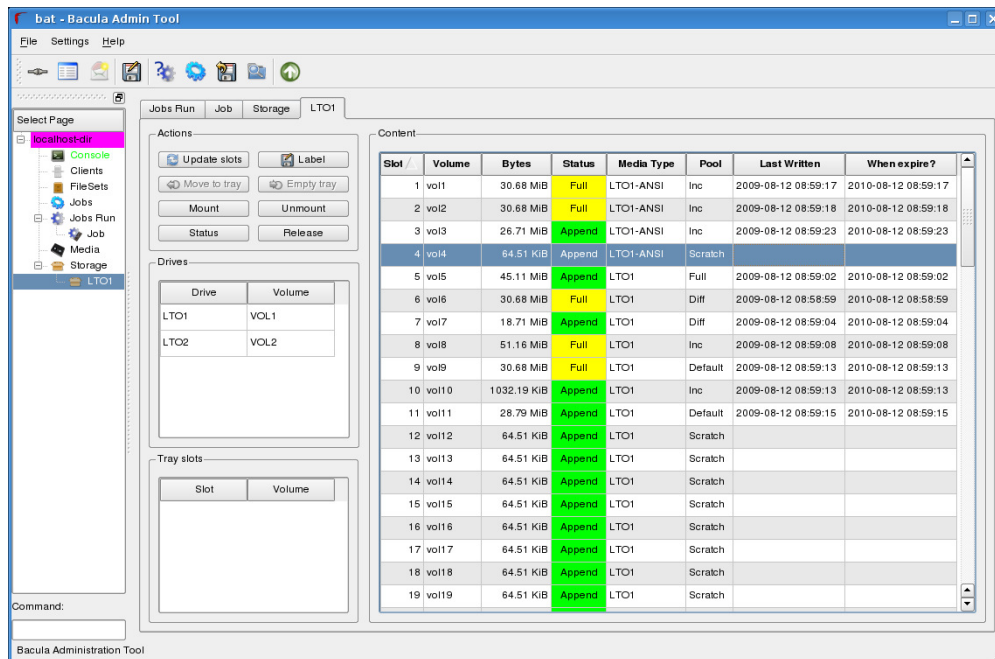

Figure 3.6: Autochanger content

```
cacls "C:\Program Files\Bacula" /T /G SYSTEM:F Administrators:F
```

- The server daemons (Director and Storage daemon) are no longer included in the Windows installer. If you want the Windows servers, you will either need to build them yourself (note they have not been ported to 64 bits), or you can contact Bacula Systems about this.

3.5.15 Win64 Installer

We have corrected a number of problems that required manual editing of the conf files. In most cases, it should now install and work. **bat** is by default installed in **c:/Program Files/Bacula/bin32** rather than **c:/Program Files/Bacula** as is the case with the 32 bit Windows installer.

3.5.16 Linux Bare Metal Recovery USB Key

We have made a number of significant improvements in the Bare Metal Recovery USB key. Please see the README files in the **rescue** release for more details.

We are working on an equivalent USB key for Windows bare metal recovery, but it will take some time to develop it (best estimate 3Q2010 or 4Q2010)

3.5.17 bconsole Timeout Option

You can now use the **-u** option of **bconsole** to set a timeout in seconds for commands. This is useful with GUI programs that use **bconsole** to interface to the Director.

3.5.18 Important Changes

- You are now allowed to Migrate, Copy, and Virtual Full to read and write to the same Pool. The Storage daemon ensures that you do not read and write to the same Volume.
- The **Device Poll Interval** is now 5 minutes. (previously did not poll by default).
- Virtually all the features of **mtx-changer** have now been parametrized, which allows you to configure **mtx-changer** without changing it. There is a new configuration file **mtx-changer.conf** that contains variables that you can set to configure **mtx-changer**. This configuration file will not be overwritten during upgrades. We encourage you to submit any changes that are made to **mtx-changer** and to parametrize it all in **mtx-changer.conf** so that all configuration will be done by changing only **mtx-changer.conf**.

- The new `mtx-changer` script has two new options, `listall` and `transfer`. Please configure them as appropriate in `mtx-changer.conf`.
- To enhance security of the `BackupCatalog` job, we provide a new script (`make_catalog_backup.pl`) that does not expose your catalog password. If you want to use the new script, you will need to manually change the `BackupCatalog` Job definition.
- The `bconsole help` command now accepts an argument, which if provided produces information on that command (ex: `help run`).

Truncate volume after purge

Note that the Truncate Volume after purge feature doesn't work as expected in 5.0.0 version. Please, don't use it before version 5.0.1.

Custom Catalog queries

If you wish to add specialized commands that list the contents of the catalog, you can do so by adding them to the `query.sql` file. This `query.sql` file is now empty by default. The file `examples/sample-query.sql` has an a number of sample commands you might find useful.

Deprecated parts

The following items have been **deprecated** for a long time, and are now removed from the code.

- Gnome console
- Support for SQLite 2

3.5.19 Misc Changes

- Updated Nagios `check_bacula`
- Updated man files
- Added OSX package generation script in `platforms/darwin`
- Added Spanish and Ukrainian Bacula translations
- `Enable/disable` command shows only Jobs that can change
- Added `show disabled` command to show disabled Jobs
- Many ACL improvements
- Added Level to FD status Job output
- Begin Ingres DB driver (not yet working)
- Split RedHat spec files into `bacula`, `bat`, `mtx`, and `docs`
- Reorganized the manuals (fewer separate manuals)
- Added lock/unlock order protection in lock manager
- Allow 64 bit sizes for a number of variables
- Fixed several deadlocks or potential race conditions in the SD





Chapter 4

Released Version 3.0.3 and 3.0.3a

There are no new features in version 3.0.3. This version simply fixes a number of bugs found in version 3.0.2 during the ongoing development process.

4.1 New Features in Released Version 3.0.2

This chapter presents the new features added to the Released Bacula Version 3.0.2.

4.1.1 Full Restore from a Given JobId

This feature allows selecting a single JobId and having Bacula automatically select all the other jobs that comprise a full backup up to and including the selected date (through JobId).

Assume we start with the following jobs:

jobid	client	starttime	level	jobfiles	jobbytes
6	localhost-fd	2009-07-15 11:45:49	I	2	0
5	localhost-fd	2009-07-15 11:45:45	I	15	44143
3	localhost-fd	2009-07-15 11:45:38	I	1	10
1	localhost-fd	2009-07-15 11:45:30	F	1527	44143073

Below is an example of this new feature (which is number 12 in the menu).

```
* restore
To select the JobIds, you have the following choices:
  1: List last 20 Jobs run
  2: List Jobs where a given File is saved
...
 12: Select full restore to a specified Job date
 13: Cancel
```

```
Select item: (1-13): 12
Enter JobId to get the state to restore: 5
Selecting jobs to build the Full state at 2009-07-15 11:45:45
You have selected the following JobIds: 1,3,5
```

```
Building directory tree for JobId(s) 1,3,5 ... ++++++
1,444 files inserted into the tree.
```

This project was funded by Bacula Systems.

4.1.2 Source Address

A feature has been added which allows the administrator to specify the address from which the Director and File daemons will establish connections. This may be used to simplify system configuration overhead when working in complex networks utilizing multi-homing and policy-routing.



To accomplish this, two new configuration directives have been implemented:

```
FileDaemon {
  FDSrcAddress=10.0.1.20    # Always initiate connections from this address
}

Director {
  DirSrcAddress=10.0.1.10   # Always initiate connections from this address
}
```

Simply adding specific host routes on the OS would have an undesirable side-effect: any application trying to contact the destination host would be forced to use the more specific route possibly diverting management traffic onto a backup VLAN. Instead of adding host routes for each client connected to a multi-homed backup server (for example where there are management and backup VLANs), one can use the new directives to specify a specific source address at the application level.

Additionally, this allows the simplification and abstraction of firewall rules when dealing with a Hot-Standby director or storage daemon configuration. The Hot-standby pair may share a CARP address, which connections must be sourced from, while system services listen and act from the unique interface addresses.

This project was funded by Collaborative Fusion, Inc.

4.1.3 Show volume availability when doing restore

When doing a restore the selection dialog ends by displaying this screen:

```
The job will require the following
Volume(s)                Storage(s)                SD Device(s)
=====
*000741L3                 LTO-4                     LT03
*000866L3                 LTO-4                     LT03
*000765L3                 LTO-4                     LT03
*000764L3                 LTO-4                     LT03
*000756L3                 LTO-4                     LT03
*001759L3                 LTO-4                     LT03
*001763L3                 LTO-4                     LT03
 001762L3                 LTO-4                     LT03
 001767L3                 LTO-4                     LT03
```

Volumes marked with ‘*’ are online (in the autochanger).

This should help speed up large restores by minimizing the time spent waiting for the operator to discover that he must change tapes in the library.

This project was funded by Bacula Systems.

4.1.4 Accurate estimate command

The `estimate` command can now use the accurate code to detect changes and give a better estimation.

You can set the accurate behavior on the command line by using `accurate=yes|no` or use the Job setting as default value.

```
* estimate listing accurate=yes level=incremental job=BackupJob
```

This project was funded by Bacula Systems.

4.2 New Features in 3.0.0

This chapter presents the new features added to the development 2.5.x versions to be released as Bacula version 3.0.0 sometime in April 2009.



4.2.1 Accurate Backup

As with most other backup programs, by default Bacula decides what files to backup for Incremental and Differential backup by comparing the change (`st_ctime`) and modification (`st_mtime`) times of the file to the time the last backup completed. If one of those two times is later than the last backup time, then the file will be backed up. This does not, however, permit tracking what files have been deleted and will miss any file with an old time that may have been restored to or moved onto the client filesystem.

Accurate = <yes|no>

If the **Accurate** = <yes|no> directive is enabled (default no) in the Job resource, the job will be run as an Accurate Job. For a **Full** backup, there is no difference, but for **Differential** and **Incremental** backups, the Director will send a list of all previous files backed up, and the File daemon will use that list to determine if any new files have been added or or moved and if any files have been deleted. This allows Bacula to make an accurate backup of your system to that point in time so that if you do a restore, it will restore your system exactly.

One note of caution about using Accurate backup is that it requires more resources (CPU and memory) on both the Director and the Client machines to create the list of previous files backed up, to send that list to the File daemon, for the File daemon to keep the list (possibly very big) in memory, and for the File daemon to do comparisons between every file in the FileSet and the list. In particular, if your client has lots of files (more than a few million), you will need lots of memory on the client machine.

Accurate must not be enabled when backing up with a plugin that is not specially designed to work with Accurate. If you enable it, your restores will probably not work correctly.

This project was funded by Bacula Systems.

4.2.2 Copy Jobs

A new **Copy** job type 'C' has been implemented. It is similar to the existing Migration feature with the exception that the Job that is copied is left unchanged. This essentially creates two identical copies of the same backup. However, the copy is treated as a copy rather than a backup job, and hence is not directly available for restore. The **restore** command lists copy jobs and allows selection of copies by using `jobid=` option. If the keyword **copies** is present on the command line, Bacula will display the list of all copies for selected jobs.

```
* restore copies
[...]
```

These JobIds have copies as follows:

```

+-----+-----+-----+-----+-----+-----+
| JobId | Job                               | CopyJobId | MediaType          |
+-----+-----+-----+-----+-----+-----+
| 2     | CopyJobSave.2009-02-17_16.31.00.11 | 7         | DiskChangerMedia  |
+-----+-----+-----+-----+-----+-----+
+-----+-----+-----+-----+-----+-----+
| JobId | Level | JobFiles | JobBytes | StartTime          | VolumeName          |
+-----+-----+-----+-----+-----+-----+
| 19   | F     | 6274    | 76565018 | 2009-02-17 16:30:45 | ChangerVolume002  |
| 2    | I     | 1       | 5        | 2009-02-17 16:30:51 | FileVolume001     |
+-----+-----+-----+-----+-----+-----+

```

You have selected the following JobIds: 19,2

```

Building directory tree for JobId(s) 19,2 ... +-----+
5,611 files inserted into the tree.
...

```

The Copy Job runs without using the File daemon by copying the data from the old backup Volume to a different Volume in a different Pool. See the Migration documentation for additional details. For copy Jobs there is a new selection directive named **PoolUncopiedJobs** which selects all Jobs that were not already copied to another Pool.

As with Migration, the Client, Volume, Job, or SQL query, are other possible ways of selecting the Jobs to be copied. Selection types like `SmallestVolume`, `OldestVolume`, `PoolOccupancy` and `PoolTime` also work, but are probably more suited for Migration Jobs.



If Bacula finds a Copy of a job record that is purged (deleted) from the catalog, it will promote the Copy to a *real* backup job and will make it available for automatic restore. If more than one Copy is available, it will promote the copy with the smallest JobId.

A nice solution which can be built with the new Copy feature is often called disk-to-disk-to-tape backup (DTDDTT). A sample config could look something like the one below:

```
Pool {
  Name = FullBackupsVirtualPool
  Pool Type = Backup
  Purge Oldest Volume = Yes
  Storage = vtl
  NextPool = FullBackupsTapePool
}

Pool {
  Name = FullBackupsTapePool
  Pool Type = Backup
  Recycle = Yes
  AutoPrune = Yes
  Volume Retention = 365 days
  Storage = superloader
}

#
# Fake fileset for copy jobs
#
Fileset {
  Name = None
  Include {
    Options {
      signature = MD5
    }
  }
}

#
# Fake client for copy jobs
#
Client {
  Name = None
  Address = localhost
  Password = "NoNe"
  Catalog = MyCatalog
}

#
# Default template for a CopyDiskToTape Job
#
JobDefs {
  Name = CopyDiskToTape
  Type = Copy
  Messages = StandardCopy
  Client = None
  FileSet = None
  Selection Type = PoolUncopiedJobs
  Maximum Concurrent Jobs = 10
  SpoolData = No
  Allow Duplicate Jobs = Yes
  Cancel Queued Duplicates = No
  Cancel Running Duplicates = No
}
```



```

Priority = 13
}

Schedule {
    Name = DaySchedule7:00
    Run = Level=Full daily at 7:00
}

Job {
    Name = CopyDiskToTapeFullBackups
    Enabled = Yes
    Schedule = DaySchedule7:00
    Pool = FullBackupsVirtualPool
    JobDefs = CopyDiskToTape
}

```

The example above had 2 pool which are copied using the PoolUncopiedJobs selection criteria. Normal Full backups go to the Virtual pool and are copied to the Tape pool the next morning.

The command `list copies [jobid=x,y,z]` lists copies for a given **jobid**.

```
*list copies
```

```

+-----+-----+-----+-----+-----+
| JobId | Job                               | CopyJobId | MediaType          |
+-----+-----+-----+-----+-----+
|      9 | CopyJobSave.2008-12-20_22.26.49.05 |          11 | DiskChangerMedia  |
+-----+-----+-----+-----+-----+

```

4.2.3 ACL Updates

The whole ACL code had been overhauled and in this version each platform has different streams for each type of acl available on such an platform. As ACLs between platforms tend to be not that portable (most implement POSIX acls but some use an other draft or a completely different format) we currently only allow certain platform specific ACL streams to be decoded and restored on the same platform that they were created on. The old code allowed to restore ACL cross platform but the comments already mention that not being to wise. For backward compatibility the new code will accept the two old ACL streams and handle those with the platform specific handler. But for all new backups it will save the ACLs using the new streams.

Currently the following platforms support ACLs:

- **AIX**
- **Darwin/OSX**
- **FreeBSD**
- **HPUX**
- **IRIX**
- **Linux**
- **Tru64**
- **Solaris**

Currently we support the following ACL types (these ACL streams use a reserved part of the stream numbers):

- **STREAM_ACL_AIX_TEXT** 1000 AIX specific string representation from `acl_get`
- **STREAM_ACL_DARWIN_ACCESS_ACL** 1001 Darwin (OSX) specific `acl_t` string representation from `acl_to_text` (POSIX acl)
- **STREAM_ACL_FREEBSD_DEFAULT_ACL** 1002 FreeBSD specific `acl_t` string representation from `acl_to_text` (POSIX acl) for default acls.



- **STREAM_ACL_FREEBSD_ACCESS_ACL** 1003 FreeBSD specific `acl_t` string representation from `acl_to_text` (POSIX `acl`) for access acls.
- **STREAM_ACL_HPUX_ACL_ENTRY** 1004 HPUX specific `acl_entry` string representation from `acltostr` (POSIX `acl`)
- **STREAM_ACL_IRIX_DEFAULT_ACL** 1005 IRIX specific `acl_t` string representation from `acl_to_text` (POSIX `acl`) for default acls.
- **STREAM_ACL_IRIX_ACCESS_ACL** 1006 IRIX specific `acl_t` string representation from `acl_to_text` (POSIX `acl`) for access acls.
- **STREAM_ACL_LINUX_DEFAULT_ACL** 1007 Linux specific `acl_t` string representation from `acl_to_text` (POSIX `acl`) for default acls.
- **STREAM_ACL_LINUX_ACCESS_ACL** 1008 Linux specific `acl_t` string representation from `acl_to_text` (POSIX `acl`) for access acls.
- **STREAM_ACL_TRU64_DEFAULT_ACL** 1009 Tru64 specific `acl_t` string representation from `acl_to_text` (POSIX `acl`) for default acls.
- **STREAM_ACL_TRU64_DEFAULT_DIR_ACL** 1010 Tru64 specific `acl_t` string representation from `acl_to_text` (POSIX `acl`) for default acls.
- **STREAM_ACL_TRU64_ACCESS_ACL** 1011 Tru64 specific `acl_t` string representation from `acl_to_text` (POSIX `acl`) for access acls.
- **STREAM_ACL_SOLARIS_ACLNT** 1012 Solaris specific `aclnt_t` string representation from `acltotext` or `acl_totext` (POSIX `acl`)
- **STREAM_ACL_SOLARIS_ACE** 1013 Solaris specific `ace_t` string representation from `acl_totext` (NFSv4 or ZFS `acl`)

In future versions we might support conversion functions from one type of `acl` into another for types that are either the same or easily convertible. For now the streams are separate and restoring them on a platform that doesn't recognize them will give you a warning.

4.2.4 Extended Attributes

Something that was on the project list for some time is now implemented for platforms that support a similar kind of interface. It's the support for backup and restore of so-called extended attributes. As extended attributes are so platform-specific these attributes are saved in separate streams for each platform. Restores of the extended attributes can only be performed on the same platform the backup was done. There is support for all types of extended attributes, but restoring from one type of filesystem onto another type of filesystem on the same platform may lead to surprises. As extended attributes can contain any type of data they are stored as a series of so-called value-pairs. This data must be seen as mostly binary and is stored as such. As security labels from `selinux` are also extended attributes this option also stores those labels and no specific code is enabled for handling `selinux` security labels.

Currently the following platforms support extended attributes:

- Darwin/OSX
- FreeBSD
- Linux
- NetBSD

On Linux `acls` are also extended attributes, as such when you enable ACLs on a Linux platform it will NOT save the same data twice e.g. it will save the ACLs and not the same extended attribute.

To enable the backup of extended attributes please add the following to your fileset definition.

```
FileSet {
  Name = "MyFileSet"
  Include {
    Options {
      signature = MD5
      xattrsupport = yes
    }
    File = ...
  }
}
```

4.2.5 Shared objects

A default build of Bacula will now create the libraries as shared objects (.so) rather than static libraries as was previously the case. The shared libraries are built using **libtool** so it should be quite portable.

An important advantage of using shared objects is that on a machine with the Directory, File daemon, the Storage daemon, and a console, you will have only one copy of the code in memory rather than four copies. Also the total size of the binary release is smaller since the library code appears only once rather than once for every program that uses it; this results in significant reduction in the size of the binaries particularly for the utility tools.

In order for the system loader to find the shared objects when loading the Bacula binaries, the Bacula shared objects must either be in a shared object directory known to the loader (typically /usr/lib) or they must be in the directory that may be specified on the `./configure` line using the `--libdir` option as:

```
./configure --libdir=/full-path/dir
```

the default is /usr/lib. If `--libdir` is specified, there should be no need to modify your loader configuration provided that the shared objects are installed in that directory (Bacula does this with the `make install` command). The shared objects that Bacula references are:

```
libbaccfg.so
libbacfind.so
libbacpy.so
libbac.so
```

These files are symbolically linked to the real shared object file, which has a version number to permit running multiple versions of the libraries if desired (not normally the case).

If you have problems with libtool or you wish to use the old way of building static libraries, or you want to build a static version of Bacula you may disable libtool on the configure command line with:

```
./configure --disable-libtool
```

4.2.6 Building Static versions of Bacula

In order to build static versions of Bacula, in addition to configuration options that were needed you now must also add `--disable-libtool`. Example

```
./configure --enable-static-client-only --disable-libtool
```

4.2.7 Virtual Backup (Vbackup)

Bacula's virtual backup feature is often called Synthetic Backup or Consolidation in other backup products. It permits you to consolidate the previous Full backup plus the most recent Differential backup and any subsequent Incremental backups into a new Full backup. This new Full backup will then be considered as the most recent Full for any future Incremental or Differential backups. The VirtualFull backup is accomplished without contacting the client by reading the previous backup data and writing it to a volume in a different pool.

In some respects the Vbackup feature works similar to a Migration job, in that Bacula normally reads the data from the pool specified in the Job resource, and writes it to the **Next Pool** specified in the Job resource. Note, this means that usually the output from the Virtual Backup is written into a different pool from where your prior backups are saved. Doing it this way guarantees that you will not get a deadlock situation attempting to read and write to the same volume in the Storage daemon. If you then want to

do subsequent backups, you may need to move the Virtual Full Volume back to your normal backup pool. Alternatively, you can set your **Next Pool** to point to the current pool. This will cause Bacula to read and write to Volumes in the current pool. In general, this will work, because Bacula will not allow reading and writing on the same Volume. In any case, once a VirtualFull has been created, and a restore is done involving the most current Full, it will read the Volume or Volumes by the VirtualFull regardless of in which Pool the Volume is found.

The Vbackup is enabled on a Job by Job in the Job resource by specifying a level of **VirtualFull**.

A typical Job resource definition might look like the following:

```
Job {
  Name = "MyBackup"
  Type = Backup
  Client=localhost-fd
  FileSet = "Full Set"
  Storage = File
  Messages = Standard
  Pool = Default
  SpoolData = yes
}

# Default pool definition
Pool {
  Name = Default
  Pool Type = Backup
  Recycle = yes           # Automatically recycle Volumes
  AutoPrune = yes        # Prune expired volumes
  Volume Retention = 365d # one year
  NextPool = Full
  Storage = File
}

Pool {
  Name = Full
  Pool Type = Backup
  Recycle = yes           # Automatically recycle Volumes
  AutoPrune = yes        # Prune expired volumes
  Volume Retention = 365d # one year
  Storage = DiskChanger
}

# Definition of file storage device
Storage {
  Name = File
  Address = localhost
  Password = "xxx"
  Device = FileStorage
  Media Type = File
  Maximum Concurrent Jobs = 5
}

# Definition of DDS Virtual tape disk storage device
Storage {
  Name = DiskChanger
  Address = localhost # N.B. Use a fully qualified name here
  Password = "yyy"
  Device = DiskChanger
  Media Type = DiskChangerMedia
  Maximum Concurrent Jobs = 4
  Autochanger = yes
}
```

Then in bconsole or via a Run schedule, you would run the job as:

```
run job=MyBackup level=Full
run job=MyBackup level=Incremental
run job=MyBackup level=Differential
run job=MyBackup level=Incremental
run job=MyBackup level=Incremental
```

So providing there were changes between each of those jobs, you would end up with a Full backup, a Differential, which includes the first Incremental backup, then two Incremental backups. All the above jobs would be written to the **Default** pool.

To consolidate those backups into a new Full backup, you would run the following:

```
run job=MyBackup level=VirtualFull
```

And it would produce a new Full backup without using the client, and the output would be written to the **Full Pool** which uses the Diskchanger Storage.

If the Virtual Full is run, and there are no prior Jobs, the Virtual Full will fail with an error.

Note, the Start and End time of the Virtual Full backup is set to the values for the last job included in the Virtual Full (in the above example, it is an Increment). This is so that if another incremental is done, which will be based on the Virtual Full, it will backup all files from the last Job included in the Virtual Full rather than from the time the Virtual Full was actually run.

4.2.8 Catalog Format

Bacula 3.0 comes with some changes to the catalog format. The upgrade operation will convert the FileId field of the File table from 32 bits (max 4 billion table entries) to 64 bits (very large number of items). The conversion process can take a bit of time and will likely **DOUBLE THE SIZE** of your catalog during the conversion. Also you won't be able to run jobs during this conversion period. For example, a 3 million file catalog will take 2 minutes to upgrade on a normal machine. Please don't forget to make a valid backup of your database before executing the upgrade script. See the ReleaseNotes for additional details.

4.2.9 64 bit Windows Client

Unfortunately, Microsoft's implementation of Volume Shadow Copy (VSS) on their 64 bit OS versions is not compatible with a 32 bit Bacula Client. As a consequence, we are also releasing a 64 bit version of the Bacula Windows Client (win64bacula-3.0.0.exe) that does work with VSS. These binaries should only be installed on 64 bit Windows operating systems. What is important is not your hardware but whether or not you have a 64 bit version of the Windows OS.

Compared to the Win32 Bacula Client, the 64 bit release contains a few differences:

1. Before installing the Win64 Bacula Client, you must totally deinstall any prior 2.4.x Client installation using the Bacula deinstallation (see the menu item). You may want to save your .conf files first.
2. Only the Client (File daemon) is ported to Win64, the Director and the Storage daemon are not in the 64 bit Windows installer.
3. bwx-console is not yet ported.
4. bconsole is ported but it has not been tested.
5. The documentation is not included in the installer.
6. Due to Vista security restrictions imposed on a default installation of Vista, before upgrading the Client, you must manually stop any prior version of Bacula from running, otherwise the install will fail.
7. Due to Vista security restrictions imposed on a default installation of Vista, attempting to edit the conf files via the menu items will fail. You must directly edit the files with appropriate permissions. Generally double clicking on the appropriate .conf file will work providing you have sufficient permissions.
8. All Bacula files are now installed in **C:/Program Files/Bacula** except the main menu items, which are installed as before. This vastly simplifies the installation.



9. If you are running on a foreign language version of Windows, most likely **C:/Program Files** does not exist, so you should use the Custom installation and enter an appropriate location to install the files.
10. The 3.0.0 Win32 Client continues to install files in the locations used by prior versions. For the next version we will convert it to use the same installation conventions as the Win64 version.

This project was funded by Bacula Systems.

4.2.10 Duplicate Job Control

The new version of Bacula provides four new directives that give additional control over what Bacula does if duplicate jobs are started. A duplicate job in the sense we use it here means a second or subsequent job with the same name starts. This happens most frequently when the first job runs longer than expected because no tapes are available.

The four directives each take as an argument a **yes** or **no** value and are specified in the Job resource.

They are:

Allow Duplicate Jobs = <yes|no>

If this directive is set to **yes**, duplicate jobs will be run. If the directive is set to **no** (default) then only one job of a given name may run at one time, and the action that Bacula takes to ensure only one job runs is determined by the other directives (see below).

If **Allow Duplicate Jobs** is set to **no** and two jobs are present and none of the three directives given below permit Canceling a job, then the current job (the second one started) will be canceled.

Allow Higher Duplicates = <yes|no>

This directive was in version 5.0.0, but does not work as expected. If used, it should always be set to **no**. In later versions of Bacula the directive is disabled (disregarded).

Cancel Running Duplicates = <yes|no>

If **Allow Duplicate Jobs** is set to **no** and if this directive is set to **yes** any job that is already running will be canceled. The default is **no**.

Cancel Queued Duplicates = <yes|no>

If **Allow Duplicate Jobs** is set to **no** and if this directive is set to **yes** any job that is already queued to run but not yet running will be canceled. The default is **no**.

4.2.11 TLS Authentication

In Bacula version 2.5.x and later, in addition to the normal Bacula CRAM-MD5 authentication that is used to authenticate each Bacula connection, you can specify that you want TLS Authentication as well, which will provide more secure authentication.

This new feature uses Bacula's existing TLS code (normally used for communications encryption) to do authentication. To use it, you must specify all the TLS directives normally used to enable communications encryption (TLS Enable, TLS Verify Peer, TLS Certificate, ...) and a new directive:

TLS Authenticate = yes

TLS Authenticate = yes

in the main daemon configuration resource (Director for the Director, Client for the File daemon, and Storage for the Storage daemon).

When **TLS Authenticate** is enabled, after doing the CRAM-MD5 authentication, Bacula will also do TLS authentication, then TLS encryption will be turned off, and the rest of the communication between the two Bacula daemons will be done without encryption.

If you want to encrypt communications data, use the normal TLS directives but do not turn on **TLS Authenticate**.

4.2.12 bextract non-portable Win32 data

bextract has been enhanced to be able to restore non-portable Win32 data to any OS. Previous versions were unable to restore non-portable Win32 data to machines that did not have the Win32 BackupRead and BackupWrite API calls.

4.2.13 State File updated at Job Termination

In previous versions of Bacula, the state file, which provides a summary of previous jobs run in the **status** command output was updated only when Bacula terminated, thus if the daemon crashed, the state file might not contain all the run data. This version of the Bacula daemons updates the state file on each job termination.

4.2.14 MaxFullInterval = <time-interval>

The new Job resource directive **Max Full Interval = <time-interval>** can be used to specify the maximum time interval between **Full** backup jobs. When a job starts, if the time since the last Full backup is greater than the specified interval, and the job would normally be an **Incremental** or **Differential**, it will be automatically upgraded to a **Full** backup.

4.2.15 MaxDiffInterval = <time-interval>

The new Job resource directive **Max Diff Interval = <time-interval>** can be used to specify the maximum time interval between **Differential** backup jobs. When a job starts, if the time since the last Differential backup is greater than the specified interval, and the job would normally be an **Incremental**, it will be automatically upgraded to a **Differential** backup.

4.2.16 Honor No Dump Flag = <yes|no>

On FreeBSD systems, each file has a **no dump flag** that can be set by the user, and when it is set it is an indication to backup programs to not backup that particular file. This version of Bacula contains a new Options directive within a FileSet resource, which instructs Bacula to obey this flag. The new directive is:

```
Honor No Dump Flag = yes\vb{no}
```

The default value is **no**.

4.2.17 Exclude Dir Containing = <filename-string>

The **ExcludeDirContaining = <filename>** is a new directive that can be added to the Include section of the FileSet resource. If the specified filename (**filename-string**) is found on the Client in any directory to be backed up, the whole directory will be ignored (not backed up). For example:

```
# List of files to be backed up
FileSet {
  Name = "MyFileSet"
  Include {
    Options {
      signature = MD5
    }
    File = /home
    Exclude Dir Containing = .excludeme
  }
}
```

But in /home, there may be hundreds of directories of users and some people want to indicate that they don't want to have certain directories backed up. For example, with the above FileSet, if the user or sysadmin creates a file named **.excludeme** in specific directories, such as

```
/home/user/www/cache/.excludeme
/home/user/temp/.excludeme
```

then Bacula will not backup the two directories named:



```
/home/user/www/cache  
/home/user/temp
```

NOTE: subdirectories will not be backed up. That is, the directive applies to the two directories in question and any children (be they files, directories, etc).

4.2.18 Bacula Plugins

Support for shared object plugins has been implemented in the Linux, Unix and Win32 File daemons. The API will be documented separately in the Developer's Guide or in a new document. For the moment, there is a single plugin named **bpipe** that allows an external program to get control to backup and restore a file. Plugins are also planned (partially implemented) in the Director and the Storage daemon.

Plugin Directory

Each daemon (DIR, FD, SD) has a new **Plugin Directory** directive that may be added to the daemon definition resource. The directory takes a quoted string argument, which is the name of the directory in which the daemon can find the Bacula plugins. If this directive is not specified, Bacula will not load any plugins. Since each plugin has a distinctive name, all the daemons can share the same plugin directory.

Plugin Options

The **Plugin Options** directive takes a quoted string argument (after the equal sign) and may be specified in the Job resource. The options specified will be passed to all plugins when they are run. This each plugin must know what it is looking for. The value defined in the Job resource can be modified by the user when he runs a Job via the **bconsole** command line prompts.

Note: this directive may be specified, and there is code to modify the string in the run command, but the plugin options are not yet passed to the plugin (i.e. not fully implemented).

Plugin Options ACL

The **Plugin Options ACL** directive may be specified in the Director's Console resource. It functions as all the other ACL commands do by permitting users running restricted consoles to specify a **Plugin Options** that overrides the one specified in the Job definition. Without this directive restricted consoles may not modify the Plugin Options.

Plugin = <plugin-command-string>

The **Plugin** directive is specified in the Include section of a FileSet resource where you put your **File = xxx** directives. For example:

```
FileSet {  
  Name = "MyFileSet"  
  Include {  
    Options {  
      signature = MD5  
    }  
    File = /home  
    Plugin = "bpipe:..."  
  }  
}
```

In the above example, when the File daemon is processing the directives in the Include section, it will first backup all the files in **/home** then it will load the plugin named **bpipe** (actually bpipe-dir.so) from the Plugin Directory. The syntax and semantics of the Plugin directive require the first part of the string up to the colon (:) to be the name of the plugin. Everything after the first colon is ignored by the File daemon but is passed to the plugin. Thus the plugin writer may define the meaning of the rest of the string as he wishes.

Please see the next section for information about the **bpipe** Bacula plugin.



4.2.19 The bpipe Plugin

The **bpipe** plugin is provided in the directory `src/plugins/fd/bpipe-fd.c` of the Bacula source distribution. When the plugin is compiled and linking into the resulting dynamic shared object (DSO), it will have the name **bpipe-fd.so**. Please note that this is a very simple plugin that was written for demonstration and test purposes. It is and can be used in production, but that was never really intended.

The purpose of the plugin is to provide an interface to any system program for backup and restore. As specified above the **bpipe** plugin is specified in the Include section of your Job's FileSet resource. The full syntax of the plugin directive as interpreted by the **bpipe** plugin (each plugin is free to specify the syntax as it wishes) is:

```
Plugin = "<field1>:<field2>:<field3>:<field4>"
```

where

field1 is the name of the plugin with the trailing **-fd.so** stripped off, so in this case, we would put **bpipe** in this field.

field2 specifies the namespace, which for **bpipe** is the pseudo path and filename under which the backup will be saved. This pseudo path and filename will be seen by the user in the restore file tree. For example, if the value is `/MYSQL/regress.sql`, the data backed up by the plugin will be put under that "pseudo" path and filename. You must be careful to choose a naming convention that is unique to avoid a conflict with a path and filename that actually exists on your system.

field3 for the **bpipe** plugin specifies the "reader" program that is called by the plugin during backup to read the data. **bpipe** will call this program by doing a **popen** on it.

field4 for the **bpipe** plugin specifies the "writer" program that is called by the plugin during restore to write the data back to the filesystem.

Please note that for two items above describing the "reader" and "writer" fields, these programs are "executed" by Bacula, which means there is no shell interpretation of any command line arguments you might use. If you want to use shell characters (redirection of input or output, ...), then we recommend that you put your command or commands in a shell script and execute the script. In addition if you backup a file with the reader program, when running the writer program during the restore, Bacula will not automatically create the path to the file. Either the path must exist, or you must explicitly do so with your command or in a shell script.

Putting it all together, the full plugin directive line might look like the following:

```
Plugin = "bpipe:/MYSQL/regress.sql:mysqldump -f
        --opt --databases bacula:mysql"
```

The directive has been split into two lines, but within the **bacula-dir.conf** file would be written on a single line.

This causes the File daemon to call the **bpipe** plugin, which will write its data into the "pseudo" file `/MYSQL/regress.sql` by calling the program `mysqldump -f --opt --database bacula` to read the data during backup. The `mysqldump` command outputs all the data for the database named **bacula**, which will be read by the plugin and stored in the backup. During restore, the data that was backed up will be sent to the program specified in the last field, which in this case is **mysql**. When **mysql** is called, it will read the data sent to it by the plugin then write it back to the same database from which it came (**bacula** in this case).

The **bpipe** plugin is a generic pipe program, that simply transmits the data from a specified program to Bacula for backup, and then from Bacula to a specified program for restore.

By using different command lines to **bpipe**, you can backup any kind of data (ASCII or binary) depending on the program called.

4.2.20 Microsoft Exchange Server 2003/2007 Plugin

Background

The Exchange plugin was made possible by a funded development project between Equinix Ltd – www.equinix.com (many thanks) and Bacula Systems. The code for the plugin was written by James Harper, and the Bacula core code by Kern Sibbald. All the code for this funded development has become part of the Bacula project. Thanks to everyone who made it happen.



Concepts

Although it is possible to backup Exchange using Bacula VSS the Exchange plugin adds a good deal of functionality, because while Bacula VSS completes a full backup (snapshot) of Exchange, it does not support Incremental or Differential backups, restoring is more complicated, and a single database restore is not possible.

Microsoft Exchange organises its storage into Storage Groups with Databases inside them. A default installation of Exchange will have a single Storage Group called 'First Storage Group', with two Databases inside it, "Mailbox Store (SERVER NAME)" and "Public Folder Store (SERVER NAME)", which hold user email and public folders respectively.

In the default configuration, Exchange logs everything that happens to log files, such that if you have a backup, and all the log files since, you can restore to the present time. Each Storage Group has its own set of log files and operates independently of any other Storage Groups. At the Storage Group level, the logging can be turned off by enabling a function called "Enable circular logging". At this time the Exchange plugin will not function if this option is enabled.

The plugin allows backing up of entire storage groups, and the restoring of entire storage groups or individual databases. Backing up and restoring at the individual mailbox or email item is not supported but can be simulated by use of the "Recovery" Storage Group (see below).

Installing

The Exchange plugin requires a DLL that is shipped with Microsoft Exchanger Server called **esebcli2.dll**. Assuming Exchange is installed correctly the Exchange plugin should find this automatically and run without any additional installation.

If the DLL can not be found automatically it will need to be copied into the Bacula installation directory (eg C:\Program Files\Bacula\bin). The Exchange API DLL is named esebcli2.dll and is found in C:\Program Files\Exchsrvr\bin on a default Exchange installation.

Backing Up

To back up an Exchange server the Fileset definition must contain at least **Plugin = "exchange:/@EXCHANGE/Microsoft Information Store"** for the backup to work correctly. The 'exchange:' bit tells Bacula to look for the exchange plugin, the '@EXCHANGE' bit makes sure all the backed up files are prefixed with something that isn't going to share a name with something outside the plugin, and the 'Microsoft Information Store' bit is required also. It is also possible to add the name of a storage group to the "Plugin =" line, eg

Plugin = "exchange:/@EXCHANGE/Microsoft Information Store/First Storage Group"

if you want only a single storage group backed up.

Additionally, you can suffix the 'Plugin =' directive with ":notrunconfull" which will tell the plugin not to truncate the Exchange database at the end of a full backup.

An Incremental or Differential backup will backup only the database logs for each Storage Group by inspecting the "modified date" on each physical log file. Because of the way the Exchange API works, the last logfile backed up on each backup will always be backed up by the next Incremental or Differential backup too. This adds 5MB to each Incremental or Differential backup size but otherwise does not cause any problems.

By default, a normal VSS fileset containing all the drive letters will also back up the Exchange databases using VSS. This will interfere with the plugin and Exchange's shared ideas of when the last full backup was done, and may also truncate log files incorrectly. It is important, therefore, that the Exchange database files be excluded from the backup, although the folders the files are in should be included, or they will have to be recreated manually if a bare metal restore is done.

```
FileSet {
  Include {
    File = C:/Program Files/Exchsrvr/mdbdata
    Plugin = "exchange:..."
  }
  Exclude {
    File = C:/Program Files/Exchsrvr/mdbdata/E00.chk
    File = C:/Program Files/Exchsrvr/mdbdata/E00.log
    File = C:/Program Files/Exchsrvr/mdbdata/E000000F.log
    File = C:/Program Files/Exchsrvr/mdbdata/E0000010.log
    File = C:/Program Files/Exchsrvr/mdbdata/E0000011.log
  }
}
```

```

    File = C:/Program Files/Exchsrvr/mdbdata/E00tmp.log
    File = C:/Program Files/Exchsrvr/mdbdata/priv1.edb
  }
}
```

The advantage of excluding the above files is that you can significantly reduce the size of your backup since all the important Exchange files will be properly saved by the Plugin.

Restoring

The restore operation is much the same as a normal Bacula restore, with the following provisos:

- The **Where** restore option must not be specified
- Each Database directory must be marked as a whole. You cannot just select (say) the .edb file and not the others.
- If a Storage Group is restored, the directory of the Storage Group must be marked too.
- It is possible to restore only a subset of the available log files, but they **must** be contiguous. Exchange will fail to restore correctly if a log file is missing from the sequence of log files
- Each database to be restored must be dismounted and marked as "Can be overwritten by restore"
- If an entire Storage Group is to be restored (eg all databases and logs in the Storage Group), then it is best to manually delete the database files from the server (eg C:\Program Files\Exchsrvr\mdbdata*) as Exchange can get confused by stray log files lying around.

Restoring to the Recovery Storage Group

The concept of the Recovery Storage Group is well documented by Microsoft <http://support.microsoft.com/kb/824126> , but to briefly summarize...

Microsoft Exchange allows the creation of an additional Storage Group called the Recovery Storage Group, which is used to restore an older copy of a database (e.g. before a mailbox was deleted) into without messing with the current live data. This is required as the Standard and Small Business Server versions of Exchange can not ordinarily have more than one Storage Group.

To create the Recovery Storage Group, drill down to the Server in Exchange System Manager, right click, and select "New -> Recovery Storage Group...". Accept or change the file locations and click OK. On the Recovery Storage Group, right click and select "Add Database to Recover..." and select the database you will be restoring.

Restore only the single database nominated as the database in the Recovery Storage Group. Exchange will redirect the restore to the Recovery Storage Group automatically. Then run the restore.

Restoring on Microsoft Server 2007

Apparently the **Exmerge** program no longer exists in Microsoft Server 2007, and hence you use a new procedure for recovering a single mail box. This procedure is documented by Microsoft at: <http://technet.microsoft.com/en-us/library/aa997694.aspx> , and involves using the **Restore-Mailbox** and **Get-Mailbox Statistics** shell commands.

Caveats

This plugin is still being developed, so you should consider it currently in BETA test, and thus use in a production environment should be done only after very careful testing.

When doing a full backup, the Exchange database logs are truncated by Exchange as soon as the plugin has completed the backup. If the data never makes it to the backup medium (eg because of spooling) then the logs will still be truncated, but they will also not have been backed up. A solution to this is being worked on. You will have to schedule a new Full backup to ensure that your next backups will be usable.

The "Enable Circular Logging" option cannot be enabled or the plugin will fail.

Exchange insists that a successful Full backup must have taken place if an Incremental or Differential backup is desired, and the plugin will fail if this is not the case. If a restore is done, Exchange will require that a Full backup be done before an Incremental or Differential backup is done.

The plugin will most likely not work well if another backup application (eg NTBACKUP) is backing up the Exchange database, especially if the other backup application is truncating the log files.



The Exchange plugin has not been tested with the **Accurate** option, so we recommend either carefully testing or that you avoid this option for the current time.

The Exchange plugin is not called during processing the bconsole **estimate** command, and so anything that would be backed up by the plugin will not be added to the estimate total that is displayed.

4.2.21 libdbi Framework

As a general guideline, Bacula has support for a few catalog database drivers (MySQL, PostgreSQL, SQLite) coded natively by the Bacula team. With the libdbi implementation, which is a Bacula driver that uses libdbi to access the catalog, we have an open field to use many different kinds database engines following the needs of users.

The according to libdbi (<http://libdbi.sourceforge.net/>) project: libdbi implements a database-independent abstraction layer in C, similar to the DBI/DBD layer in Perl. Writing one generic set of code, programmers can leverage the power of multiple databases and multiple simultaneous database connections by using this framework.

Currently the libdbi driver in Bacula project only supports the same drivers natively coded in Bacula. However the libdbi project has support for many others database engines. You can view the list at <http://libdbi-drivers.sourceforge.net/>. In the future all those drivers can be supported by Bacula, however, they must be tested properly by the Bacula team.

Some of benefits of using libdbi are:

- The possibility to use proprietary databases engines in which your proprietary licenses prevent the Bacula team from developing the driver.
- The possibility to use the drivers written for the libdbi project.
- The possibility to use other database engines without recompiling Bacula to use them. Just change one line in bacula-dir.conf
- Abstract Database access, this is, unique point to code and profiling catalog database access.

The following drivers have been tested:

- PostgreSQL, with and without batch insert
- Mysql, with and without batch insert
- SQLite
- SQLite3

In the future, we will test and approve to use others databases engines (proprietary or not) like DB2, Oracle, Microsoft SQL.

To compile Bacula to support libdbi we need to configure the code with the `-with-dbi` and `-with-dbi-driver=[database]` `./configure` options, where `[database]` is the database engine to be used with Bacula (of course we can change the driver in file bacula-dir.conf, see below). We must configure the access port of the database engine with the option `-with-db-port`, because the libdbi framework doesn't know the default access port of each database.

The next phase is checking (or configuring) the bacula-dir.conf, example:

```
Catalog {
  Name = MyCatalog
  dbdriver = dbi:mysql; dbaddress = 127.0.0.1; dbport = 3306
  dbname = regress; user = regress; password = ""
}
```

The parameter **dbdriver** indicates that we will use the driver dbi with a mysql database. Currently the drivers supported by Bacula are: postgresql, mysql, sqlite, sqlite3; these are the names that may be added to string "dbi:".

The following limitations apply when Bacula is set to use the libdbi framework: - Not tested on the Win32 platform - A little performance is lost if comparing with native database driver. The reason is bound with the database driver provided by libdbi and the simple fact that one more layer of code was added.

It is important to remember, when compiling Bacula with libdbi, the following packages are needed:

- libdbi version 1.0.0, <http://libdbi.sourceforge.net/>
- libdbi-drivers 1.0.0, <http://libdbi-drivers.sourceforge.net/>

You can download them and compile them on your system or install the packages from your OS distribution.



4.2.22 Console Command Additions and Enhancements

Display Autochanger Content

The `status slots storage=<storage-name>` command displays autochanger content.

Slot	Volume Name	Status	Media Type	Pool
1	00001	Append	DiskChangerMedia	Default
2	00002	Append	DiskChangerMedia	Default
3*	00003	Append	DiskChangerMedia	Scratch
4				

If you an asterisk (*) appears after the slot number, you must run an `update slots` command to synchronize autochanger content with your catalog.

list joblog job=xxx or jobid=nnn

A new list command has been added that allows you to list the contents of the Job Log stored in the catalog for either a Job Name (fully qualified) or for a particular JobId. The `l`list command will include a line with the time and date of the entry.

Note for the catalog to have Job Log entries, you must have a directive such as:

```
catalog = all
```

In your Director's `Messages` resource.

Use separator for multiple commands

When using `bconsole` with `readline`, you can set the command separator with `@separator` command to one of those characters to write commands who require multiple input in one line.

```
!$%&'()*+,-/:;<>?[]^_{|}~
```

Deleting Volumes

The delete volume `bconsole` command has been modified to require an asterisk (*) in front of a MediaId otherwise the value you enter is a taken to be a Volume name. This is so that users may delete numeric Volume names. The previous Bacula versions assumed that all input that started with a number was a MediaId.

This new behavior is indicated in the prompt if you read it carefully.

4.2.23 Bare Metal Recovery

The old bare metal recovery project is essentially dead. One of the main features of it was that it would build a recovery CD based on the kernel on your system. The problem was that every distribution has a different boot procedure and different scripts, and worse yet, the boot procedures and scripts change from one distribution to another. This meant that maintaining (keeping up with the changes) the rescue CD was too much work.

To replace it, a new bare metal recovery USB boot stick has been developed by Bacula Systems. This technology involves remastering a Ubuntu LiveCD to boot from a USB key.

Advantages:

1. Recovery can be done from within graphical environment.
2. Recovery can be done in a shell.
3. Ubuntu boots on a large number of Linux systems.
4. The process of updating the system and adding new packages is not too difficult.
5. The USB key can easily be upgraded to newer Ubuntu versions.
6. The USB key has writable partitions for modifications to the OS and for modification to your home directory.
7. You can add new files/directories to the USB key very easily.



8. You can save the environment from multiple machines on one USB key.
9. Bacula Systems is funding its ongoing development.

The disadvantages are:

1. The USB key is usable but currently under development.
2. Not everyone may be familiar with Ubuntu (no worse than using Knoppix)
3. Some older OSes cannot be booted from USB. This can be resolved by first booting a Ubuntu LiveCD then plugging in the USB key.
4. Currently the documentation is sketchy and not yet added to the main manual. See below ...

The documentation and the code can be found in the **rescue** package in the directory **linux/usb**.

4.2.24 Miscellaneous

Allow Mixed Priority = <yes|no>

This directive is only implemented in version 2.5 and later. When set to **yes** (default **no**), this job may run even if lower priority jobs are already running. This means a high priority job will not have to wait for other jobs to finish before starting. The scheduler will only mix priorities when all running jobs have this set to true.

Note that only higher priority jobs will start early. Suppose the director will allow two concurrent jobs, and that two jobs with priority 10 are running, with two more in the queue. If a job with priority 5 is added to the queue, it will be run as soon as one of the running jobs finishes. However, new priority 10 jobs will not be run until the priority 5 job has finished.

Bootstrap File Directive – FileRegex

FileRegex is a new command that can be added to the bootstrap (.bsr) file. The value is a regular expression. When specified, only matching filenames will be restored.

During a restore, if all File records are pruned from the catalog for a Job, normally Bacula can restore only all files saved. That is there is no way using the catalog to select individual files. With this new feature, Bacula will ask if you want to specify a Regex expression for extracting only a part of the full backup.

```
Building directory tree for JobId(s) 1,3 ...
There were no files inserted into the tree, so file selection
is not possible. Most likely your retention policy pruned the files

Do you want to restore all the files? (yes\vb{ }no): no

Regex matching files to restore? (empty to abort): /tmp/regress/(bin|tests)/
Bootstrap records written to /tmp/regress/working/zog4-dir.restore.1.bsr
```

Bootstrap File Optimization Changes

In order to permit proper seeking on disk files, we have extended the bootstrap file format to include a **VolStartAddr** and **VolEndAddr** records. Each takes a 64 bit unsigned integer range (i.e. nnn-mmm) which defines the start address range and end address range respectively. These two directives replace the **VolStartFile**, **VolEndFile**, **VolStartBlock** and **VolEndBlock** directives. Bootstrap files containing the old directives will still work, but will not properly take advantage of proper disk seeking, and may read completely to the end of a disk volume during a restore. With the new format (automatically generated by the new Director), restores will seek properly and stop reading the volume when all the files have been restored.

Solaris ZFS/NFSv4 ACLs

This is an upgrade of the previous Solaris ACL backup code to the new library format, which will backup both the old POSIX(UFS) ACLs as well as the ZFS ACLs.

The new code can also restore POSIX(UFS) ACLs to a ZFS filesystem (it will translate the POSIX(UFS)) ACL into a ZFS/NFSv4 one) it can also be used to transfer from UFS to ZFS filesystems.



Virtual Tape Emulation

We now have a Virtual Tape emulator that allows us to run through 99.9% of the tape code but actually reading and writing to a disk file. Used with the **disk-changer** script, you can now emulate an autochanger with 10 drives and 700 slots. This feature is most useful in testing. It is enabled by using **Device Type = vtape** in the Storage daemon's Device directive. This feature is only implemented on Linux machines and should not be used for production.

Bat Enhancements

Bat (the Bacula Administration Tool) GUI program has been significantly enhanced and stabilized. In particular, there are new table based status commands; it can now be easily localized using Qt4 Linguist. The Bat communications protocol has been significantly enhanced to improve GUI handling. Note, you **must** use a the bat that is distributed with the Director you are using otherwise the communications protocol will not work.

RunScript Enhancements

The **RunScript** resource has been enhanced to permit multiple commands per RunScript. Simply specify multiple **Command** directives in your RunScript.

```
Job {
  Name = aJob
  RunScript {
    Command = "/bin/echo test"
    Command = "/bin/echo an other test"
    Command = "/bin/echo 3 commands in the same runscript"
    RunsWhen = Before
  }
  ...
}
```

A new Client RunScript **RunsWhen** keyword of **AfterVSS** has been implemented, which runs the command after the Volume Shadow Copy has been made.

Console commands can be specified within a RunScript by using: **Console = <command>**, however, this command has not been carefully tested and debugged and is known to easily crash the Director. We would appreciate feedback. Due to the recursive nature of this command, we may remove it before the final release.

Status Enhancements

The bconsole **status dir** output has been enhanced to indicate Storage daemon job spooling and despooling activity.

Connect Timeout

The default connect timeout to the File daemon has been set to 3 minutes. Previously it was 30 minutes.

ftruncate for NFS Volumes

If you write to a Volume mounted by NFS (say on a local file server), in previous Bacula versions, when the Volume was recycled, it was not properly truncated because NFS does not implement ftruncate (file truncate). This is now corrected in the new version because we have written code (actually a kind user) that deletes and recreates the Volume, thus accomplishing the same thing as a truncate.

Support for Ubuntu

The new version of Bacula now recognizes the Ubuntu (and Kubuntu) version of Linux, and thus now provides correct autostart routines. Since Ubuntu officially supports Bacula, you can also obtain any recent release of Bacula from the Ubuntu repositories.



Recycle Pool = <pool-name>

The new **RecyclePool** directive defines to which pool the Volume will be placed (moved) when it is recycled. Without this directive, a Volume will remain in the same pool when it is recycled. With this directive, it can be moved automatically to any existing pool during a recycle. This directive is probably most useful when defined in the Scratch pool, so that volumes will be recycled back into the Scratch pool.

FD Version

The File daemon to Director protocol now includes a version number, which although there is no visible change for users, will help us in future versions automatically determine if a File daemon is not compatible.

Max Run Sched Time = <time-period-in-seconds>

The time specifies the maximum allowed time that a job may run, counted from when the job was scheduled. This can be useful to prevent jobs from running during working hours. We can see it like **Max Start Delay + Max Run Time**.

Max Wait Time = <time-period-in-seconds>

Previous **MaxWaitTime** directives aren't working as expected, instead of checking the maximum allowed time that a job may block for a resource, those directives worked like **MaxRunTime**. Some users are reporting to use **Incr/Diff/Full Max Wait Time** to control the maximum run time of their job depending on the level. Now, they have to use **Incr/Diff/Full Max Run Time**. **Incr/Diff/Full Max Wait Time** directives are now deprecated.

Incremental—Differential Max Wait Time = <time-period-in-seconds>

These directives have been deprecated in favor of **Incremental|Differential Max Run Time**.

Max Run Time directives

Using **Full/Diff/Incr Max Run Time**, it's now possible to specify the maximum allowed time that a job can run depending on the level.

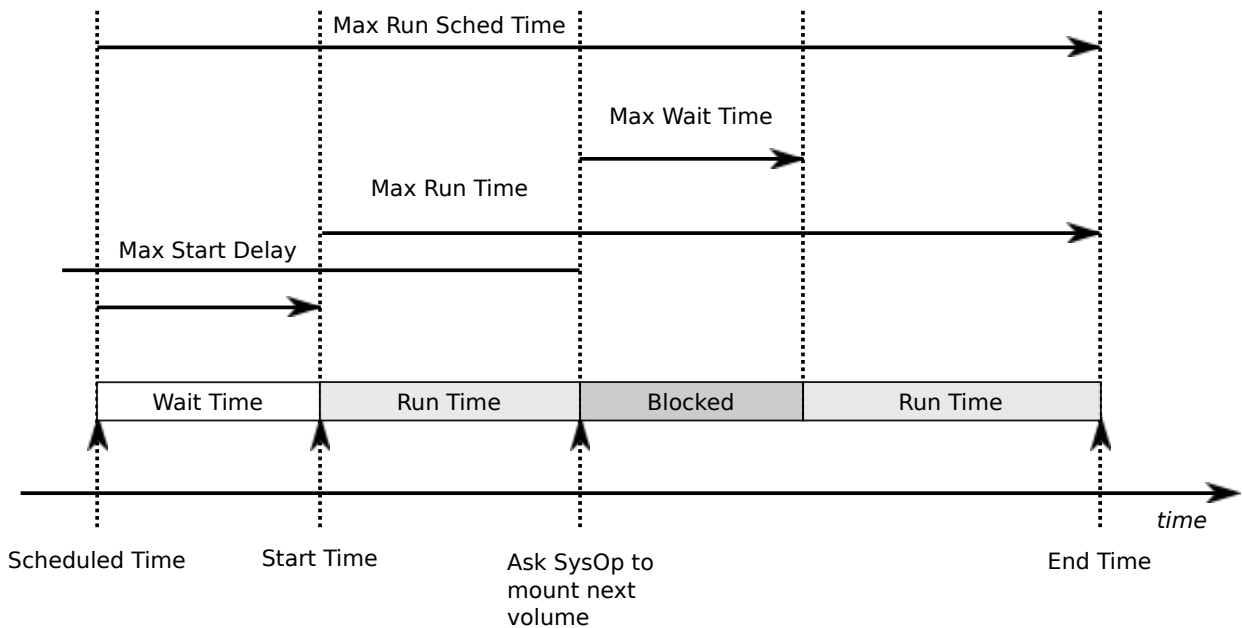

Statistics Enhancements

If you (or probably your boss) want to have statistics on your backups to provide some *Service Level Agreement* indicators, you could use a few SQL queries on the Job table to report how many:

- jobs have run

- jobs have been successful
- files have been backed up
- ...

However, these statistics are accurate only if your job retention is greater than your statistics period. Ie, if jobs are purged from the catalog, you won't be able to use them.

Now, you can use the **update stats [days=num]** console command to fill the JobHistory table with new Job records. If you want to be sure to take in account only **good jobs**, ie if one of your important job has failed but you have fixed the problem and restarted it on time, you probably want to delete the first *bad* job record and keep only the successful one. For that simply let your staff do the job, and update JobHistory table after two or three days depending on your organization using the **[days=num]** option.

These statistics records aren't used for restoring, but mainly for capacity planning, billings, etc.

The Bweb interface provides a statistics module that can use this feature. You can also use tools like Talend or extract information by yourself.

The **Statistics Retention = <time>** director directive defines the length of time that Bacula will keep statistics job records in the Catalog database after the Job End time. (In JobHistory table) When this time period expires, and if user runs **prune stats** command, Bacula will prune (remove) Job records that are older than the specified period.

You can use the following Job resource in your nightly **BackupCatalog** job to maintain statistics.

```
Job {
  Name = BackupCatalog
  ...
  RunScript {
    Console = "update stats days=3"
    Console = "prune stats yes"
    RunsWhen = After
    RunsOnClient = no
  }
}
```

ScratchPool = <pool-resource-name>

This directive permits to specify a specific *Scratch* pool for the current pool. This is useful when using multiple storage sharing the same mediatype or when you want to dedicate volumes to a particular set of pool.

Enhanced Attribute Despooling

If the storage daemon and the Director are on the same machine, the spool file that contains attributes is read directly by the Director instead of being transmitted across the network. That should reduce load and speedup insertion.

SpoolSize = <size-specification-in-bytes>

A new Job directive permits to specify the spool size per job. This is used in advanced job tuning. **SpoolSize=bytes**

MaximumConsoleConnections = <number>

A new director directive permits to specify the maximum number of Console Connections that could run concurrently. The default is set to 20, but you may set it to a larger number.

VerId = <string>

A new director directive permits to specify a personal identifier that will be displayed in the **version** command.



dbcheck enhancements

If you are using Mysql, dbcheck will now ask you if you want to create temporary indexes to speed up orphaned Path and Filename elimination.

A new `-B` option allows you to print catalog information in a simple text based format. This is useful to backup it in a secure way.

```
$ dbcheck -B
catalog=MyCatalog
db_type=SQLite
db_name=regress
db_driver=
db_user=regress
db_password=
db_address=
db_port=0
db_socket=
```

You can now specify the database connection port in the command line.

`--docdir` configure option

You can use `--docdir=` on the `./configure` command to specify the directory where you want Bacula to install the LICENSE, ReleaseNotes, ChangeLog, ... files. The default is `/usr/share/doc/bacula`.

`--htmldir` configure option

You can use `--htmldir=` on the `./configure` command to specify the directory where you want Bacula to install the bat html help files. The default is `/usr/share/doc/bacula/html`

`--with-plugindir` configure option

You can use `--plugindir=` on the `./configure` command to specify the directory where you want Bacula to install the plugins (currently only bpipe-fd). The default is `/usr/lib`.



Chapter 5

The Current State of Bacula

In other words, what is and what is not currently implemented and functional.

5.1 What is Implemented

- Job Control
 - Network backup/restore with centralized Director.
 - Internal scheduler for automatic Job execution.
 - Scheduling of multiple Jobs at the same time.
 - You may run one Job at a time or multiple simultaneous Jobs (sometimes called multiplexing).
 - Job sequencing using priorities.
 - Console interface to the Director allowing complete control. A shell, Qt4 GUI, wxWidgets GUI and Web versions of the Console program are available. Note, the Qt4 GUI program called the Bacula Administration tool or bat, offers many additional features over the shell program.
- Security
 - Verification of files previously cataloged, permitting a Tripwire like capability (system break-in detection).
 - CRAM-MD5 password authentication between each component (daemon).
 - Configurable TLS (SSL) communications encryption between each component.
 - Configurable Data (on Volume) encryption on a Client by Client basis.
 - Computation of MD5 or SHA1 signatures of the file data if requested.
- Restore Features
 - Restore of one or more files selected interactively either for the current backup or a backup prior to a specified time and date.
 - Restore of a complete system starting from bare metal. This is mostly automated for Linux systems and partially automated for Solaris. See Disaster Recovery Using Bacula. This is also reported to work on Win2K/XP systems.
 - Listing and Restoration of files using stand-alone **bls** and **bextract** tool programs. Among other things, this permits extraction of files when Bacula and/or the catalog are not available. Note, the recommended way to restore files is using the restore command in the Console. These programs are designed for use as a last resort.
 - Ability to restore the catalog database rapidly by using bootstrap files (previously saved).
 - Ability to recreate the catalog database by scanning backup Volumes using the **bscan** program.
- SQL Catalog
 - Catalog database facility for remembering Volumes, Pools, Jobs, and Files backed up.
 - Support for MySQL, PostgreSQL, and SQLite Catalog databases.
 - User extensible queries to the MySQL, PostgreSQL and SQLite databases.



- Advanced Volume and Pool Management
 - Labeled Volumes, preventing accidental overwriting (at least by Bacula).
 - Any number of Jobs and Clients can be backed up to a single Volume. That is, you can backup and restore Linux, Unix, Sun, and Windows machines to the same Volume.
 - Multi-volume saves. When a Volume is full, **Bacula** automatically requests the next Volume and continues the backup.
 - Pool and Volume library management providing Volume flexibility (e.g. monthly, weekly, daily Volume sets, Volume sets segregated by Client, ...).
 - Machine independent Volume data format. Linux, Solaris, and Windows clients can all be backed up to the same Volume if desired.
 - The Volume data format is upwards compatible so that old Volumes can always be read.
 - A flexible message handler including routing of messages from any daemon back to the Director and automatic email reporting.
 - Data spooling to disk during backup with subsequent write to tape from the spooled disk files. This prevents tape "shoe shine" during Incremental/Differential backups.
- Advanced Support for most Storage Devices
 - Autochanger support using a simple shell interface that can interface to virtually any autoloader program. A script for **mtx** is provided.
 - Support for autochanger barcodes – automatic tape labeling from barcodes.
 - Automatic support for multiple autochanger magazines either using barcodes or by reading the tapes.
 - Support for multiple drive autochangers.
 - Raw device backup/restore. Restore must be to the same device.
 - All Volume blocks (approximately 64K bytes) contain a data checksum.
 - Migration support – move data from one Pool to another or one Volume to another.
 - Supports writing to DVD.
- Multi-Operating System Support
 - Programmed to handle arbitrarily long filenames and messages.
 - GZIP compression on a file by file basis done by the Client program if requested before network transit.
 - Saves and restores POSIX ACLs and Extended Attributes on most OSES if enabled.
 - Access control lists for Consoles that permit restricting user access to only their data.
 - Support for save/restore of files larger than 2GB.
 - Support for 64 bit machines, e.g. amd64, Sparc.
 - Support ANSI and IBM tape labels.
 - Support for Unicode filenames (e.g. Chinese) on Win32 machines
 - Consistent backup of open files on Win32 systems (WinXP, Win2003, and Vista) but not Win2000, using Volume Shadow Copy (VSS).
 - Support for path/filename lengths of up to 64K on Win32 machines (unlimited on Unix/Linux machines).
- Miscellaneous
 - Multi-threaded implementation.
 - A comprehensive and extensible configuration file for each daemon.



5.2 Advantages Over Other Backup Programs

- Since there is a client for each machine, you can backup and restore clients of any type ensuring that all attributes of files are properly saved and restored.
- It is also possible to backup clients without any client software by using NFS or Samba. However, if possible, we recommend running a Client File daemon on each machine to be backed up.
- Bacula handles multi-volume backups.
- A full comprehensive SQL standard database of all files backed up. This permits online viewing of files saved on any particular Volume.
- Automatic pruning of the database (removal of old records) thus simplifying database administration.
- Any SQL database engine can be used making Bacula very flexible. Drivers currently exist for MySQL, PostgreSQL, and SQLite.
- The modular but integrated design makes Bacula very scalable.
- Since Bacula uses client file servers, any database or other application can be properly shutdown by Bacula using the native tools of the system, backed up, then restarted (all within a Bacula Job).
- Bacula has a built-in Job scheduler.
- The Volume format is documented and there are simple C programs to read/write it.
- Bacula uses well defined (IANA registered) TCP/IP ports – no rpcs, no shared memory.
- Bacula installation and configuration is relatively simple compared to other comparable products.
- According to one user Bacula is as fast as the big major commercial applications.
- According to another user Bacula is four times as fast as another commercial application, probably because that application stores its catalog information in a large number of individual files rather than an SQL database as Bacula does.
- Aside from several GUI administrative interfaces, Bacula has a comprehensive shell administrative interface, which allows the administrator to use tools such as ssh to administrate any part of Bacula from anywhere (even from home).
- Bacula has a Rescue CD for Linux systems with the following features:
 - You build it on your own system from scratch with one simple command: `make – well`, then `make burn`.
 - It uses your kernel
 - It captures your current disk parameters and builds scripts that allow you to automatically re-partition a disk and format it to put it back to what you had before.
 - It has a script that will restart your networking (with the right IP address)
 - It has a script to automatically mount your hard disks.
 - It has a full Bacula FD statically linked
 - You can easily add additional data/programs, ... to the disk.

5.3 Current Implementation Restrictions

- It is very unusual to attempt to restore two Jobs that ran simultaneously in a single restore, but if you do, please be aware that unless you had data spooling turned on and the spool file held the full contents of both Jobs during the backup, the restore will not work correctly. In other terms, Bacula cannot restore two jobs in the same restore if the Jobs' data blocks were intermixed on the backup medium. The problem is resolved by simply doing two restores, one for each Job. Normally this can happen only if you manually enter specific JobIds to be restored in a single restore Job.
- Bacula can generally restore any backup made from one client to any other client. However, if the architecture is significantly different (i.e. 32 bit architecture to 64 bit or Win32 to Unix), some restrictions may apply (e.g. Solaris door files do not exist on other Unix/Linux machines; there are reports that Zlib compression written with 64 bit machines does not always read correctly on a 32 bit machine).



5.4 Design Limitations or Restrictions

- Names (resource names, Volume names, and such) defined in Bacula configuration files are limited to a fixed number of characters. Currently the limit is defined as 127 characters. Note, this does not apply to filenames, which may be arbitrarily long.
- Command line input to some of the stand alone tools – e.g. `btape`, `bconsole` is restricted to several hundred characters maximum. Normally, this is not a restriction, except in the case of listing multiple Volume names for programs such as `bscan`. To avoid this command line length restriction, please use a `.bsr` file to specify the Volume names.
- Bacula configuration files for each of the components can be any length. However, the length of an individual line is limited to 500 characters after which it is truncated. If you need lines longer than 500 characters for directives such as ACLs where they permit a list of names are character strings simply specify multiple short lines repeating the directive on each line but with different list values.

5.5 Items to Note

- Bacula's Differential and Incremental *normal* backups are based on time stamps. Consequently, if you move files into an existing directory or move a whole directory into the backup fileset after a Full backup, those files will probably not be backed up by an Incremental save because they will have old dates. This problem is corrected by using Accurate mode backups or by explicitly updating the date/time stamp on all moved files.
- In older versions of Bacula ($\leq 3.0.x$), if you have over 4 billion file entries stored in your database, the database FileId is likely to overflow. This limitation does not apply to current Bacula versions.
- In non *Accurate* mode, files deleted after a Full save will be included in a restoration. This is typical for most similar backup programs. To avoid this, use Accurate mode backup.



Chapter 6

System Requirements

- **Bacula** has been compiled and run on OpenSuSE Linux, FreeBSD, and Solaris systems.
- It requires GNU C++ version 2.95 or higher to compile. You can try with other compilers and older versions, but you are on your own. We have successfully compiled and used Bacula using GNU C++ version 4.1.3. Note, in general GNU C++ is a separate package (e.g. RPM) from GNU C, so you need them both loaded. On Red Hat systems, the C++ compiler is part of the **gcc-c++** rpm package.
- There are certain third party packages that Bacula may need. Except for MySQL and PostgreSQL, they can all be found in the **depkgs** and **depkgs1** releases. However, most current Linux and FreeBSD systems provide these as system packages.
- The minimum versions for each of the databases supported by Bacula are:
 - MySQL 4.1
 - PostgreSQL 7.4
 - SQLite 3
- If you want to build the Win32 binaries, please see the README.mingw32 file in the src/win32 directory. We cross-compile the Win32 release on Linux. We provide documentation on building the Win32 version, but due to the complexity, you are pretty much on your own if you want to build it yourself.
- **Bacula** requires a good implementation of pthreads to work. This is not the case on some of the BSD systems.
- The source code has been written with portability in mind and is mostly POSIX compatible. Thus porting to any POSIX compatible operating system should be relatively easy.
- The GNOME Console program is developed and tested under GNOME 2.x. GNOME 1.4 is no longer supported.
- The wxWidgets Console program is developed and tested with the latest stable ANSI or Unicode version of wxWidgets (2.6.1). It works fine with the Windows and GTK+-2.x version of wxWidgets, and should also work on other platforms supported by wxWidgets.
- The Tray Monitor program is developed for GTK+-2.x. It needs GNOME less or equal to 2.2, KDE greater or equal to 3.1 or any window manager supporting the FreeDesktop system tray standard .
- If you want to enable command line editing and history, you will need to have /usr/include/termcap.h and either the termcap or the ncurses library loaded (libtermcap-devel or ncurses-devel).
- If you want to use DVD as backup medium, you will need to download the dvd+rw-tools 5.21.4.10.8 , apply the patch that is in the **patches** directory of the main source tree to make these tools compatible with Bacula, then compile and install them. There is also a patch for dvd+rw-tools version 6.1, and we hope that the patch is integrated into a later version. Do not use the dvd+rw-tools provided by your distribution, unless you are sure it contains the patch. dvd+rw-tools without the patch will not work with Bacula. DVD media is not recommended for serious or important backups because of its low reliability.





Chapter 7

Supported Operating Systems

X Fully supported

★ The are reported to work in many cases and the Community has committed code for them. However they are not directly supported by the Bacula project, as we don't have the hardware.

Operating Systems	Version	Client Daemon	Director Daemon	Storage Daemon
GNU/Linux	All	X	X	X
FreeBSD	≥ 5.0	X	X	X
Solaris	≥ 8	X	X	X
OpenSolaris		X	X	X
MS Windows 32bit	Win98/Me	X		
	WinNT/2K	X	★	★
MS Windows 64bit	XP	X	★	★
	2008/Vista	X	★	★
	2008/Vista	X	★	★
MacOS X/Darwin		X	★	★
OpenBSD		X	★	
NetBSD		X	★	
Irix		★		
True64		★		
AIX	≥ 4.3	★		
BSDI		★		
HPUX		★		

Important notes

- By GNU/Linux, we mean 32/64bit Gentoo, Red Hat, Fedora, Mandriva, Debian, OpenSuSE, Ubuntu, Kubuntu, ...
- For FreeBSD older than version 5.0, please see some **important** considerations in the **Tape Modes on FreeBSD** section (section 3.3.6 on page 41) of Bacula Community Problem Resolution Guide.
- MS Windows Director and Storage daemon are available in the binary Client installer
- For MacOSX see <http://fink.sourceforge.net/> for obtaining the packages



See the **Porting** chapter (chapter 11 on page 79) of the Bacula Community Developers Manual for information on porting to other systems.

If you have a older Red Hat Linux system running the 2.4.x kernel and you have the directory `/lib/tls` installed on your system (normally by default), bacula will **NOT** run. This is the new pthreads library and it is defective. You must remove this directory prior to running Bacula, or you can simply change the name to `/lib/tls-broken` then you must reboot your machine (one of the few times Linux must be rebooted). If you are not able to remove/rename `/lib/tls`, an alternative is to set the environment variable `"LD_ASSUME_KERNEL=2.4.19"` prior to executing Bacula. For this option, you do not need to reboot, and all programs other than Bacula will continue to use `/lib/tls`. The above mentioned `/lib/tls` problem does not occur with Linux 2.6 kernels.



Chapter 8

Supported Tape Drives

Bacula uses standard operating system calls (read, write, ioctl) to interface to tape drives. As a consequence, it relies on having a correctly written OS tape driver. Bacula is known to work perfectly well with SCSI tape drivers on FreeBSD, Linux, Solaris, and Windows machines, and it may work on other *nix machines. Recently there are many new drives that use IDE, ATAPI, or SATA interfaces rather than SCSI. On Linux the OnStream drive, which uses the OSST driver is one such example, and it is known to work with Bacula. In addition a number of such tape drives (i.e. OS drivers) seem to work on Windows systems. However, non-SCSI tape drives (other than the OnStream) that use ide-scis, ide-tape, or other non-scsi drivers do not function correctly with Bacula (or any other demanding tape application) as of today (April 2007). If you have purchased a non-SCSI tape drive for use with Bacula on Linux, there is a good chance that it will not work. We are working with the kernel developers to rectify this situation, but it will not be resolved in the near future.

Generally any modern tape drive (i.e. after 2010) will work out of the box with Bacula using the standard Bacula Device specification in the bacula-sd.conf file.

Even if your drive is on the list below, please check the **Tape Testing** section (section 3.2 on page 33) of the Bacula Community Problem Resolution Guide for procedures that you can use to verify if your tape drive will work with Bacula. If your drive is in fixed block mode, it may appear to work with Bacula until you attempt to do a restore and Bacula wants to position the tape. You can be sure only by following the procedures suggested above and testing.

It is very difficult to supply a list of supported tape drives, or drives that are known to work with Bacula because of limited feedback (so if you use Bacula on a different drive, please let us know). Based on user feedback, the following drives are known to work with Bacula. A dash in a column means unknown:

OS	Man.	Media	Model	Capacity
-	ADIC	DLT	Adic Scalar 100 DLT	100GB
-	ADIC	DLT	Adic Fastor 22 DLT	-
FreeBSD 5.4- RELEASE- p1 amd64	Certance	LTO	AdicCertance CL400 LTO Ultrium 2	200GB
-	-	DDS	Compaq DDS 2,3,4	-
SuSE 8.1 Pro	Compaq	AIT	Compaq AIT 35 LVD	35/70GB
-	HP	Travan 4	Colorado T4000S	-
-	HP	DLT	HP DLT drives	-
-	HP	LTO	HP LTO Ultrium drives	-
-	IBM	??	3480, 3480XL, 3490, 3490E, 3580 and 3590 drives	-
FreeBSD 4.10 RE- LEASE	HP	DAT	HP StorageWorks DAT72i	-
-	Overland	LTO	LoaderXpress LTO	-



OS	Man.	Media	Model	Capacity
–	Overland	–	Neo2000	–
–	OnStream	–	OnStream drives (see below)	–
FreeBSD 4.11-Release	Quantum	SDLT	SDLT320	160/320GB
–	Quantum	DLT	DLT-8000	40/80GB
Linux	Seagate	DDS-4	Scorpio 40	20/40GB
FreeBSD 4.9 STABLE	Seagate	DDS-4	STA2401LW	20/40GB
FreeBSD 5.2.1 pthreads patched RELEASE	Seagate	AIT-1	STA1701W	35/70GB
Linux	Sony	DDS-2,3,4	–	4-40GB
Linux	Tandberg	–	Tandbert MLR3	–
FreeBSD	Tandberg	–	Tandberg SLR6	–
Solaris	Tandberg	–	Tandberg SLR75	–

There is a list of supported autochangers in the Supported Autochangers chapter of this document, where you will find other tape drives that work with Bacula.

8.1 Unsupported Tape Drives

Previously OnStream IDE-SCSI tape drives did not work with Bacula. As of Bacula version 1.33 and the osst kernel driver version 0.9.14 or later, they now work. Please see the testing chapter as you must set a fixed block size.

QIC tapes are known to have a number of particularities (fixed block size, and one EOF rather than two to terminate the tape). As a consequence, you will need to take a lot of care in configuring them to make them work correctly with Bacula.

8.2 FreeBSD Users Be Aware!!!

Unless you have patched the pthreads library on FreeBSD 4.11 systems, you will lose data when Bacula spans tapes. This is because the unpatched pthreads library fails to return a warning status to Bacula that the end of the tape is near. This problem is fixed in FreeBSD systems released after 4.11. Please see the **Tape testing** section (section 3.3.6 on page 41) of Bacula Community Problem Resolution Guide for **important** information on how to configure your tape drive for compatibility with Bacula Community.

8.3 Supported Autochangers

For information on supported autochangers, please see the Autochangers Known to Work with Bacula section of the Supported Autochangers chapter of this manual.

8.4 Tape Specifications

If you want to know what tape drive to buy that will work with Bacula, we really cannot tell you. However, we can say that if you are going to buy a drive, you should try to avoid DDS drives. The technology is rather old and DDS tape drives need frequent cleaning. DLT drives are generally much better (newer technology) and do not need frequent cleaning.

Below, you will find a table of DLT and LTO tape specifications that will give you some idea of the capacity and speed of modern tapes. The capacities that are listed are the native tape capacity without compression. All modern drives have hardware compression, and manufacturers often list compressed capacity using a compression ration of 2:1. The actual compression ratio will depend mostly on the data you have to backup, but I find that 1.5:1 is a much more reasonable number (i.e. multiply the value shown in the table by 1.5 to get a rough average of what you will probably see). The transfer rates are rounded to the nearest GB/hr. All values are provided by various manufacturers.

The Media Type is what is designated by the manufacturers and you are not required to use (but you may) the same name in your Bacula conf resources.

Media Type	Drive Type	Media Capacity	Transfer Rate
DDS-1	DAT	2 GB	?? GB/hr
DDS-2	DAT	4 GB	?? GB/hr
DDS-3	DAT	12 GB	5.4 GB/hr
Travan 40	Travan	20 GB	?? GB/hr
DDS-4	DAT	20 GB	11 GB/hr
VXA-1	Exabyte	33 GB	11 GB/hr
DAT-72	DAT	36 GB	13 GB/hr
DLT IV	DLT8000	40 GB	22 GB/hr
VXA-2	Exabyte	80 GB	22 GB/hr
Half-high Ultrium 1	LTO 1	100 GB	27 GB/hr
Ultrium 1	LTO 1	100 GB	54 GB/hr
Super DLT 1	SDLT 220	110 GB	40 GB/hr
VXA-3	Exabyte	160 GB	43 GB/hr
Super DLT I	SDLT 320	160 GB	58 GB/hr
Ultrium 2	LTO 2	200 GB	108 GB/hr
Super DLT II	SDLT 600	300 GB	127 GB/hr
VXA-4	Exabyte	320 GB	86 GB/hr
Ultrium 3	LTO 3	400 GB	216 GB/hr





Chapter 9

Getting Started with Bacula

If you are like me, you want to get Bacula running immediately to get a feel for it, then later you want to go back and read about all the details. This chapter attempts to accomplish just that: get you going quickly without all the details. If you want to skip the section on Pools, Volumes and Labels, you can always come back to it, but please read to the end of this chapter, and in particular follow the instructions for testing your tape drive.

We assume that you have managed to build and install Bacula, if not, you might want to first look at the System Requirements then at the Compiling and Installing Bacula chapter of this manual.

9.1 Understanding Jobs and Schedules

In order to make Bacula as flexible as possible, the directions given to Bacula are specified in several pieces. The main instruction is the job resource, which defines a job. A backup job generally consists of a FileSet, a Client, a Schedule for one or several levels or times of backups, a Pool, as well as additional instructions. Another way of looking at it is the FileSet is what to backup; the Client is who to backup; the Schedule defines when, and the Pool defines where (i.e. what Volume).

Typically one FileSet/Client combination will have one corresponding job. Most of the directives, such as FileSets, Pools, Schedules, can be mixed and matched among the jobs. So you might have two different Job definitions (resources) backing up different servers using the same Schedule, the same Fileset (backing up the same directories on two machines) and maybe even the same Pools. The Schedule will define what type of backup will run when (e.g. Full on Monday, incremental the rest of the week), and when more than one job uses the same schedule, the job priority determines which actually runs first. If you have a lot of jobs, you might want to use JobDefs, where you can set defaults for the jobs, which can then be changed in the job resource, but this saves rewriting the identical parameters for each job. In addition to the FileSets you want to back up, you should also have a job that backs up your catalog.

Finally, be aware that in addition to the backup jobs there are restore, verify, and admin jobs, which have different requirements.

9.2 Understanding Pools, Volumes and Labels

If you have been using a program such as **tar** to backup your system, Pools, Volumes, and labeling may be a bit confusing at first. A Volume is a single physical tape (or possibly a single file) on which Bacula will write your backup data. Pools group together Volumes so that a backup is not restricted to the length of a single Volume (tape). Consequently, rather than explicitly naming Volumes in your Job, you specify a Pool, and Bacula will select the next appendable Volume from the Pool and request you to mount it.

Although the basic Pool options are specified in the Director's Pool resource, the **real** Pool is maintained in the Bacula Catalog. It contains information taken from the Pool resource (bacula-dir.conf) as well as information on all the Volumes that have been added to the Pool. Adding Volumes to a Pool is usually done manually with the Console program using the **label** command.

For each Volume, Bacula maintains a fair amount of catalog information such as the first write date/time, the last write date/time, the number of files on the Volume, the number of bytes on the Volume, the number of Mounts, etc.

Before Bacula will read or write a Volume, the physical Volume must have a Bacula software label so that Bacula can be sure the correct Volume is mounted. This is usually done using the **label** command in the Console program.



The steps for creating a Pool, adding Volumes to it, and writing software labels to the Volumes, may seem tedious at first, but in fact, they are quite simple to do, and they allow you to use multiple Volumes (rather than being limited to the size of a single tape). Pools also give you significant flexibility in your backup process. For example, you can have a "Daily" Pool of Volumes for Incremental backups and a "Weekly" Pool of Volumes for Full backups. By specifying the appropriate Pool in the daily and weekly backup Jobs, you thereby insure that no daily Job ever writes to a Volume in the Weekly Pool and vice versa, and Bacula will tell you what tape is needed and when.

For more on Pools, see the Pool Resource section of the Director Configuration chapter, or simply read on, and we will come back to this subject later.

9.3 Setting Up Bacula Configuration Files

After running the appropriate `./configure` command and doing a `make`, and a `make install`, if this is the first time you are running Bacula, you must create valid configuration files for the Director, the File daemon, the Storage daemon, and the Console programs. If you have followed our recommendations, default configuration files as well as the daemon binaries will be located in your installation directory. In any case, the binaries are found in the directory you specified on the `--sbindir` option to the `./configure` command, and the configuration files are found in the directory you specified on the `--sysconfdir` option.

When initially setting up Bacula you will need to invest a bit of time in modifying the default configuration files to suit your environment. This may entail starting and stopping Bacula a number of times until you get everything right. Please do not despair. Once you have created your configuration files, you will rarely need to change them nor will you stop and start Bacula very often. Most of the work will simply be in changing the tape when it is full.

9.3.1 Configuring the Console Program

The Console program is used by the administrator to interact with the Director and to manually start/stop Jobs or to obtain Job status information.

The Console configuration file is found in the directory specified on the `--sysconfdir` option that you specified on the `./configure` command and by default is named `bconsole.conf`.

The same applies to the wxWidgets console, which is build with the `--enable-bwx-console` option, and the name of the default configuration file is, in this case, `bwx-console.conf`.

Normally, for first time users, no change is needed to these files. Reasonable defaults are set.

Further details are in the Console configuration chapter.

9.3.2 Configuring the Monitor Program

The Monitor program is typically an icon in the system tray. However, once the icon is expanded into a full window, the administrator or user can obtain status information about the Director or the backup status on the local workstation or any other Bacula daemon that is configured.

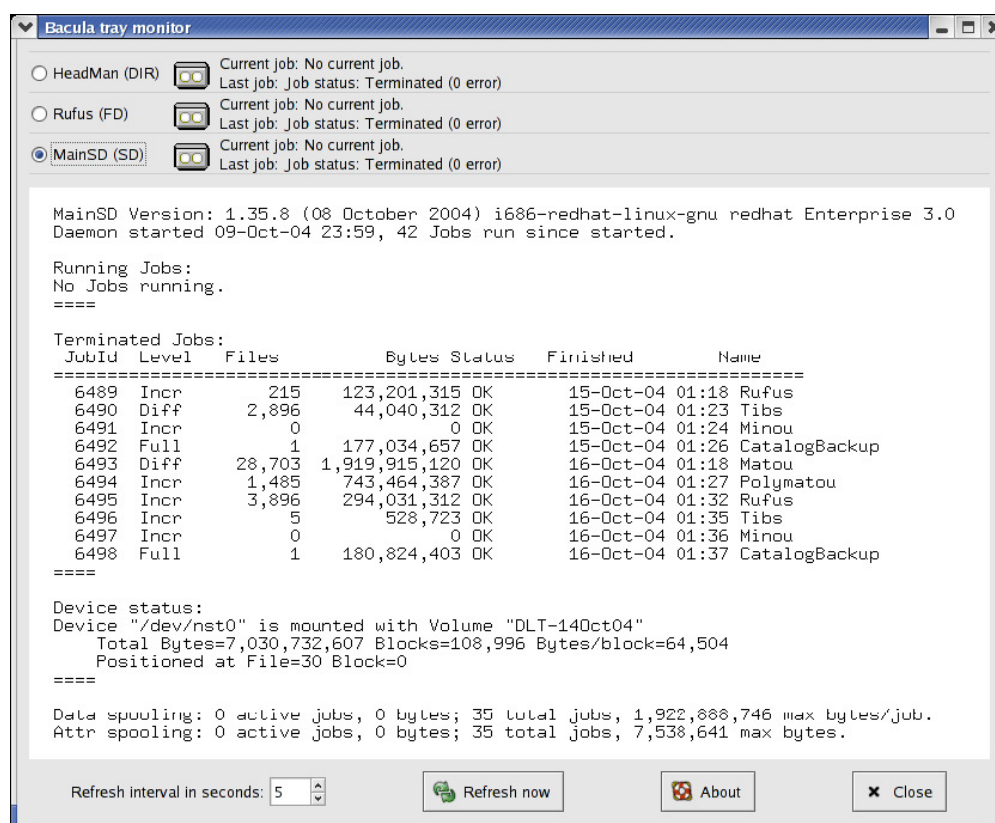

The image shows a tray-monitor configured for three daemons. By clicking on the radio buttons in the upper left corner of the image, you can see the status for each of the daemons. The image shows the status for the Storage daemon (MainSD) that is currently selected.

The Monitor configuration file is found in the directory specified on the `--sysconfdir` option that you specified on the `./configure` command and by default is named `tray-monitor.conf`. Normally, for first time users, you just need to change the permission of this file to allow non-root users to run the Monitor, as this application must run as the same user as the graphical environment (don't forget to allow non-root users to execute `bacula-tray-monitor`). This is not a security problem as long as you use the default settings. More information is in the Monitor configuration chapter.

9.3.3 Configuring the File daemon

The File daemon is a program that runs on each (Client) machine. At the request of the Director, finds the files to be backed up and sends them (their data) to the Storage daemon.

The File daemon configuration file is found in the directory specified on the `--sysconfdir` option that you specified on the `./configure` command. By default, the File daemon's configuration file is named `bacula-fd.conf`. Normally, for first time users, no change is needed to this file. Reasonable defaults are set. However, if you are going to back up more than one machine, you will need to install the File daemon with a unique configuration file on each machine to be backed up. The information about each File daemon must appear in the Director's configuration file.

Further details are in the File daemon configuration chapter.

9.3.4 Configuring the Director

The Director is the central control program for all the other daemons. It schedules and monitors all jobs to be backed up.

The Director configuration file is found in the directory specified on the `--sysconfdir` option that you specified on the `./configure` command. Normally the Director's configuration file is named `bacula-dir.conf`. In general, the only change you must make is modify the FileSet resource so that the `Include` configuration directive contains at least one line with a valid name of a directory (or file) to be saved.

If you do not have a DLT tape drive, you will probably want to edit the Storage resource to contain names that are more representative of your actual storage device. You can always use the existing names as you are free to arbitrarily assign them, but they must agree with the corresponding names in the Storage daemon's configuration file.



You may also want to change the email address for notification from the default **root** to your email address. Finally, if you have multiple systems to be backed up, you will need a separate File daemon or Client specification for each system, specifying its name, address, and password. We have found that giving your daemons the same name as your system but post fixed with **-fd** helps a lot in debugging. That is, if your system name is **foobaz**, you would give the File daemon the name **foobaz-fd**. For the Director, you should use **foobaz-dir**, and for the storage daemon, you might use **foobaz-sd**. Each of your Bacula components **must** have a unique name. If you make them all the same, aside from the fact that you will not know what daemon is sending what message, if they share the same working directory, the daemons temporary file names will not be unique, and you will get many strange failures. More information is in the Director configuration chapter.

9.3.5 Configuring the Storage daemon

The Storage daemon is responsible, at the Director's request, for accepting data from a File daemon and placing it on Storage media, or in the case of a restore request, to find the data and send it to the File daemon.

The Storage daemon's configuration file is found in the directory specified on the **--sysconfdir** option that you specified on the **./configure** command. By default, the Storage daemon's file is named **bacula-sd.conf**. Edit this file to contain the correct Archive device names for any tape devices that you have. If the configuration process properly detected your system, they will already be correctly set. These Storage resource name and Media Type must be the same as the corresponding ones in the Director's configuration file **bacula-dir.conf**. If you want to backup to a file instead of a tape, the Archive device must point to a directory in which the Volumes will be created as files when you label the Volume.

Further information is in the Storage daemon configuration chapter.

9.4 Testing your Configuration Files

You can test if your configuration file is syntactically correct by running the appropriate daemon with the **-t** option. The daemon will process the configuration file and print any error messages then terminate. For example, assuming you have installed your binaries and configuration files in the same directory.

```
cd <installation-directory>
./bacula-dir -t -c bacula-dir.conf
./bacula-fd -t -c bacula-fd.conf
./bacula-sd -t -c bacula-sd.conf
./bconsole -t -c bconsole.conf
./bwx-console -t -c bwx-console.conf
./bat -t -c bat.conf
su <normal user> -c "./bacula-tray-monitor -t -c tray-monitor.conf"
```

will test the configuration files of each of the main programs. If the configuration file is OK, the program will terminate without printing anything. Please note that, depending on the configure options you choose, some, or even all, of the three last commands will not be available on your system. If you have installed the binaries in traditional Unix locations rather than a single file, you will need to modify the above commands appropriately (no **./** in front of the command name, and a path in front of the conf file name).

9.5 Testing Compatibility with Your Tape Drive

Before spending a lot of time on Bacula only to find that it doesn't work with your tape drive, please read the **Testing Your Tape Drive** chapter of this manual. If you have a modern standard SCSI tape drive on a Linux or Solaris, most likely it will work, but better test than be sorry. For FreeBSD (and probably other xBSD flavors), reading the above mentioned tape testing chapter is a must. Also, for FreeBSD, please see *The FreeBSD Diary* for a detailed description on how to make Bacula work on your system. In addition, users of FreeBSD prior to 4.9-STABLE dated Mon Dec 29 15:18:01 2003 UTC who plan to use tape devices, please see the file **platforms/freebsd/ptreads-fix.txt** in the main Bacula directory concerning important information concerning compatibility of Bacula and your system.

9.6 Get Rid of the **/lib/tls** Directory

The new pthreads library **/lib/tls** installed by default on recent Red Hat systems running Linux kernel 2.4.x is defective. You must remove it or rename it, then reboot your system before running Bacula otherwise



after a week or so of running, Bacula will either block for long periods or deadlock entirely. You may want to use the loader environment variable override rather than removing `/lib/tls`. Please see Supported Operating Systems for more information on this problem.

This problem does not occur on systems running Linux 2.6.x kernels.

9.7 Running Bacula

Probably the most important part of running Bacula is being able to restore files. If you haven't tried recovering files at least once, when you actually have to do it, you will be under a lot more pressure, and prone to make errors, than if you had already tried it once.

To get a good idea how to use Bacula in a short time, we **strongly** recommend that you follow the example in the Running Bacula Chapter of this manual where you will get detailed instructions on how to run Bacula.

9.8 Log Rotation

If you use the default `bacula-dir.conf` or some variation of it, you will note that it logs all the Bacula output to a file. To avoid that this file grows without limit, we recommend that you copy the file `logrotate` from the `scripts/logrotate` to `/etc/logrotate.d/bacula`. This will cause the log file to be rotated once a month and kept for a maximum of five months. You may want to edit this file to change the default log rotation preferences.

9.9 Log Watch

Some systems such as Red Hat and Fedora run the `logwatch` program every night, which does an analysis of your log file and sends an email report. If you wish to include the output from your Bacula jobs in that report, please look in the `scripts/logwatch` directory. The `README` file in that directory gives a brief explanation on how to install it and what kind of output to expect.

9.10 Disaster Recovery

If you intend to use Bacula as a disaster recovery tool rather than simply a program to restore lost or damaged files, you will want to read the Disaster Recovery Using Bacula Chapter of this manual.

In any case, you are strongly urged to carefully test restoring some files that you have saved rather than wait until disaster strikes. This way, you will be prepared.





Chapter 10

Installing Bacula

In general, you will need the Bacula source release, and if you want to run a Windows client, you will need the Bacula Windows binary release. However, Bacula needs certain third party packages (such as **MySQL**, **PostgreSQL**, or **SQLite** to build and run properly depending on the options you specify. Normally, **MySQL** and **PostgreSQL** are packages that can be installed on your distribution. However, if you do not have them, to simplify your task, we have combined a number of these packages into three **depkgs** releases (Dependency Packages). This can vastly simplify your life by providing you with all the necessary packages rather than requiring you to find them on the Web, load them, and install them.

10.1 Source Release Files

Beginning with Bacula 1.38.0, the source code has been broken into four separate tar files each corresponding to a different module in the Bacula SVN. The released files are:

bacula-5.0.0.tar.gz This is the primary source code release for Bacula. On each release the version number (5.0.0) will be updated.

bacula-docs-5.0.0.tar.bz2 This file contains a copy of the docs directory with the documents prebuild. English HTML directory, single HTML file, and pdf file. The French, German, Spanish translations are in progress, but are not built.

bacula-gui-5.0.0.tar.gz This file contains the non-core GUI programs. Currently, it contains bacula-web, a PHP program for producing management viewing of your Bacula job status in a browser; and bimagemgr a browser program for burning CDROM images with Bacula Volumes.

bacula-rescue-5.0.0.tar.gz This is the Bacula Rescue USB key code. Note, the version number of this package is not always tied to the Bacula release version, so it may be different. Using this code, you can create a USB key with your system configuration and containing a statically linked version of the File daemon. This can permit you to easily repartition and reformat your hard disks and reload your system with Bacula in the case of a hard disk failure.

win32bacula-5.0.0.exe This file is the 32 bit Windows installer for installing the Windows client (File daemon) on a Windows machine. This client will also run on 64 bit Windows machines, but VSS support is not available if you are running a 64 bit version of Windows. This installer installs only the FD, the Director and Storage daemon are not included.

win64bacula-5.0.0.exe This file is the 64 bit Windows installer for installing the Windows client (File daemon) on a Windows machine. This client will only run on 64 bit Windows OS machines. It will not run on 32 bit machines or 32 bit Windows OSes. The win64bacula release is necessary for Volume Shadow Copy (VSS) to work on Win64 OSes. This installer installs only the FD, the Director and Storage daemon are not included.

10.2 Upgrading Bacula

If you are upgrading from one Bacula version to another, you should first carefully read the ReleaseNotes of all major versions between your current version and the version to which you are upgrading. In many



upgrades, especially for minor patch upgrades (e.g. between 3.0.0 and 3.0.1) there will be no database upgrade, and hence the process is rather simple.

With version 3.0.0 and later, you **must** ensure that on any one machine that all components of Bacula are running on exactly the same version. Prior to version 3.0.0, it was possible to run a lower level FD with a newer Director and SD. This is no longer the case.

As always, we attempt to support older File daemons. This avoids the need to do a simultaneous upgrade of many machines. For exactly what older versions of the FD are supported, please see the ReleaseNotes for the new version. In any case, you must always upgrade both the Director and the Storage daemon at the same time, and you must also upgrade any File daemon that is running on the same machine as a Director or a Storage daemon (see the prior paragraph).

If the Bacula catalog database has been upgraded (as it is almost every major release), you will either need to reinitialize your database starting from scratch (not normally a good idea), or save an ASCII copy of your database, then proceed to upgrade it. If you are upgrading two major versions (e.g. 1.36 to 2.0) then life will be more complicated because you must do two database upgrades. See below for more on this.

Upgrading the catalog is normally done after Bacula is build and installed by:

```
cd <installed-scripts-dir> (default /etc/bacula)
./update_bacula_tables
```

This update script can also be found in the Bacula source src/cats directory.

If there are several database upgrades between your version and the version to which you are upgrading, you will need to apply each database upgrade script. For your convenience, you can find all the old upgrade scripts in the **upgradedb** directory of the source code. You will need to edit the scripts to correspond to your system configuration. The final upgrade script, if any, can be applied as noted above.

If you are upgrading from one major version to another, you will need to replace all your components at the same time as generally the inter-daemon protocol will change. However, within any particular release (e.g. version 1.32.x) unless there is an oversight or bug, the daemon protocol will not change. If this is confusing, simply read the ReleaseNotes very carefully as they will note if all daemons must be upgraded at the same time.

Finally, please note that in general it is not necessary or desirable to do a **make uninstall** before doing an upgrade providing you are careful not to change the installation directories. In fact, if you do so, you will most likely delete all your conf files, which could be disastrous. The normal procedure during an upgrade is simply:

```
./configure (your options)
make
make install
```

In general none of your existing .conf or .sql files will be overwritten, and you must do both the **make** and **make install** commands, a **make install** without the preceding **make** will not work.

For additional information on upgrading, please see the **Upgrading Bacula Versions** section (section 2.1 on page 17) of the Bacula Community Problem Resolution Guide.

10.3 Releases Numbering

Every Bacula release whether beta or production has a different number as well as the date of the release build. The numbering system follows traditional Open Source conventions in that it is of the form.

`major.minor.release`

For example:

1.38.11

where each component (major, minor, patch) is a number. The major number is currently 1 and normally does not change very frequently. The minor number starts at 0 and increases each for each production release by 2 (i.e. it is always an even number for a production release), and the patch number is starts at zero each time the minor number changes. The patch number is increased each time a bug fix (or fixes) is released to production.

So, as of this date (10 September 2006), the current production Bacula release is version 1.38.11. If there are bug fixes, the next release will be 1.38.12 (i.e. the patch number has increased by one).



For all patch releases where the minor version number does not change, the database and all the daemons will be compatible. That means that you can safely run a 1.38.0 Director with a 1.38.11 Client. Of course, in this case, the Director may have bugs that are not fixed. Generally, within a minor release (some minor releases are not so minor), all patch numbers are officially released to production. This means that while the current Bacula version is 1.38.11, versions 1.38.0, 1.38.1, ... 1.38.10 have all been previously released. When the minor number is odd, it indicates that the package is under development and thus may not be stable. For example, while the current production release of Bacula is currently 1.38.11, the current development version is 1.39.22. All patch versions of the development code are available in the SVN (source repository). However, not all patch versions of the development code (odd minor version) are officially released. When they are released, they are released as beta versions (see below for a definition of what beta means for Bacula releases).

In general when the minor number increases from one production release to the next (i.e. 1.38.x to 1.40.0), the catalog database must be upgraded, the Director and Storage daemon must always be on the same minor release number, and often (not always), the Clients must also be on the same minor release. As often as possible, we attempt to make new releases that are downwards compatible with prior clients, but this is not always possible. You must check the release notes. In general, you will have fewer problems if you always run all the components on the same minor version number (i.e. all either 1.38.x or 1.40.x but not mixed).

Beta Releases

Towards the end of the development cycle, which typically runs one year from a major release to another, there will be several beta releases of the development code prior to a production release. As noted above, beta versions always have odd minor version numbers (e.g 1.37.x or 1.39.x). The purpose of the beta releases is to allow early adopter users to test the new code. Beta releases are made with the following considerations:

- The code passes the regression testing on FreeBSD, Linux, and Solaris machines.
- There are no known major bugs, or on the rare occasion that there are, they will be documented or already in the bugs database.
- Some of the new code/features may not yet be tested.
- Bugs are expected to be found, especially in the new code before the final production release.
- The code will have been run in production in at least one small site (mine).
- The Win32 client will have been run in production at least one night at that small site.
- The documentation in the manual is unlikely to be complete especially for the new features, and the Release Notes may not be fully organized.
- Beta code is not generally recommended for everyone, but rather for early adopters.

10.4 Dependency Packages

As discussed above, we have combined a number of third party packages that Bacula might need into the **depkgs** release. You can, of course, get the latest packages from the original authors or from your operating system supplier. The locations of where we obtained the packages are in the README file in each package. However, be aware that the packages in the depkgs files have been tested by us for compatibility with Bacula. Typically, a dependency package will be named **depkgs-ddMMMyy.tar.gz** where **dd** is the day we release it, **MMM** is the abbreviated month (e.g. Jan), and **yy** is the year. An actual example is: **depkgs-18Dec.tar.gz**. To install and build this package (if needed), you do the following:

1. Create a **bacula** directory, into which you will place both the Bacula source as well as the dependency package.
2. Detar the **depkgs** into the **bacula** directory.
3. cd bacula/depkgs
4. make

Although the exact composition of the dependency packages may change from time to time, the current makeup is the following:



3rd Party Package	depkgs	depkgs-qt
SQLite3	X	
mtx	X	
qt4		X

Note, some of these packages are quite large, so that building them can be a bit time consuming. The above instructions will build all the packages contained in the directory. However, when building Bacula, it will take only those pieces that it actually needs.

Alternatively, you can make just the packages that are needed. For example,

```
cd bacula/depkgs
make sqlite
```

will configure and build only the SQLite package.

You should build the packages that you will require in **depkgs** a prior to configuring and building Bacula, since Bacula will need them during the build process.

Note, the **depkgs-qt** package is required for building bat, because bat is currently built with Qt version 4.3.4. It can be built with other Qt versions, but that almost always creates problems or introduces instabilities.

You can build the depkgs-qt with the following:

```
cd bacula
tar xfvz depkgs-qt-28Jul09.tar.gz
cd depkgs-qt
make qt4
source qt4-path
```

Doing the **source qt4-path** defines the following environment variables:

```
QTDIR
QTLIB
QTINC
```

Each one should point to a specific location in the depkgs-qt package that you loaded. It also puts the depkgs-qt/qt4/bin directory on your path before all other directories. This ensures that the bat build will use your Qt 4.3.4 library rather than any that might be on your system.

Before running your Bacula build, please make sure that **qmake-qt4** is not on your path. If it is please rename it. If you don't do this, Bacula will attempt to build with any Qt4 package installed on your system rather than the one you just built. If you logoff and log back in, you must re-source the depkgs-qt/qt4-patch file before attempting to rebuild the bat part of Bacula.

For more information on the **depkgs-qt** package, please read the INSTALL file in the main directory of that package. If you are going to build Qt4 using **depkgs-qt**, you must source the **qt4-paths** file included in the package prior to building Bacula. Please read the INSTALL file for more details.

Even if you do not use SQLite, you might find it worthwhile to build **mtx** because the **tapeinfo** program that comes with it can often provide you with valuable information about your SCSI tape drive (e.g. compression, min/max block sizes, ...). Note, most distros provide **mtx** as part of their release.

The **depkgs1** package is deprecated and previously contained readline, which should be available on all operating systems.

The **depkgs-win32** package is deprecated and no longer used in Bacula version 1.39.x and later. It was previously used to build the native Win32 client program, but this program is now built on Linux systems using cross-compiling. All the tools and third party libraries are automatically downloaded by executing the appropriate scripts. See src/win32/README.mingw32 for more details.

10.5 Supported Operating Systems

Please see the Supported Operating Systems section of the QuickStart chapter of this manual.



10.6 Building Bacula from Source

The basic installation is rather simple.

1. Install and build any **depkgs** as noted above. This should be unnecessary on most modern Operating Systems.
2. Configure and install MySQL or PostgreSQL (if desired). Installing and Configuring MySQL Phase I or Installing and Configuring PostgreSQL Phase I. If you are installing from rpms, and are using MySQL, please be sure to install **mysql-devel**, so that the MySQL header files are available while compiling Bacula. In addition, the MySQL client library **mysqlclient** requires the gzip compression library **libz.a** or **libz.so**. If you are using rpm packages, these libraries are in the **libz-devel** package. On Debian systems, you will need to load the **zlib1g-dev** package. If you are not using rpms or debs, you will need to find the appropriate package for your system.

Note, if you already have a running MySQL or PostgreSQL on your system, you can skip this phase provided that you have built the thread safe libraries. And you have already installed the additional rpms noted above.

SQLite is not supported on Solaris. This is because it frequently fails with bus errors. However SQLite3 may work.

3. Detar the Bacula source code preferably into the **bacula** directory discussed above.
4. **cd** to the directory containing the source code.
5. **./configure** (with appropriate options as described below). Any path names you specify as options on the **./configure** command line must be absolute paths and not relative.
6. Check the output of **./configure** very carefully, especially the Install binaries and Install config directories. If they are not correct, please rerun **./configure** until they are. The output from **./configure** is stored in **config.out** and can be re-displayed at any time without rerunning the **./configure** by doing **cat config.out**.
7. If after running **./configure** once, you decide to change options and re-run it, that is perfectly fine, but before re-running it, you should run:

```
make distclean
```

so that you are sure to start from scratch and not have a mixture of the two options. This is because **./configure** caches much of the information. The **make distclean** is also critical if you move the source directory from one machine to another. If the **make distclean** fails, just ignore it and continue on.

8. **make** If you get errors while linking in the Storage daemon directory (**src/stored**), it is probably because you have not loaded the static libraries on your system. I noticed this problem on a Solaris system. To correct it, make sure that you have not added **-enable-static-tools** to the **./configure** command. If you skip this step (**make**) and proceed immediately to the **make install** you are making two serious errors: 1. your install will fail because Bacula requires a **make** before a **make install**. 2. you are depriving yourself of the chance to make sure there are no errors before beginning to write files to your system directories.
9. **make install** Please be sure you have done a **make** before entering this command, and that everything has properly compiled and linked without errors.
10. If you are new to Bacula, we **strongly** recommend that you skip the next step and use the default configuration files, then run the example program in the next chapter, then come back and modify your configuration files to suit your particular needs.
11. Customize the configuration files for each of the three daemons (Directory, File, Storage) and for the Console program. For the details of how to do this, please see Setting Up Bacula Configuration Files in the Configuration chapter of this manual. We recommend that you start by modifying the default configuration files supplied, making the minimum changes necessary. Complete customization can be done after you have Bacula up and running. Please take care when modifying passwords, which were randomly generated, and the **Names** as the passwords and names must agree between the configuration files for security reasons.



12. Create the Bacula MySQL database and tables (if using MySQL) Installing and Configuring MySQL Phase II or create the Bacula PostgreSQL database and tables Configuring PostgreSQL II or alternatively if you are using SQLite Installing and Configuring SQLite Phase II.
13. Start Bacula (`./bacula start`) Note. the next chapter shows you how to do this in detail.
14. Interface with Bacula using the Console program
15. For the previous two items, please follow the instructions in the Running Bacula chapter of this manual, where you will run a simple backup and do a restore. Do this before you make heavy modifications to the configuration files so that you are sure that Bacula works and are familiar with it. After that changing the conf files will be easier.
16. If after installing Bacula, you decide to "move it", that is to install it in a different set of directories, proceed as follows:

```
make uninstall
make distclean
./configure (your-new-options)
make
make install
```

If all goes well, the `./configure` will correctly determine which operating system you are running and configure the source code appropriately. Currently, FreeBSD, Linux (Red Hat), and Solaris are supported. The Bacula client (File daemon) is reported to work with MacOS X 10.3 is if readline support is not enabled (default) when building the client.

If you install Bacula on more than one system, and they are identical, you can simply transfer the source tree to that other system and do a "make install". However, if there are differences in the libraries or OS versions, or you wish to install on a different OS, you should start from the original compress tar file. If you do transfer the source tree, and you have previously done a `./configure` command, you **MUST** do:

```
make distclean
```

prior to doing your new `./configure`. This is because the GNU autoconf tools cache the configuration, and if you re-use a configuration for a Linux machine on a Solaris, you can be sure your build will fail. To avoid this, as mentioned above, either start from the tar file, or do a "make distclean".

In general, you will probably want to supply a more complicated **configure** statement to ensure that the modules you want are built and that everything is placed into the correct directories.

For example, on Fedora, Red Hat, or SuSE one could use the following:

```
CFLAGS="-g -Wall" \  
./configure \  
  --sbindir=/opt/bacula/bin \  
  --sysconfdir=/opt/bacula/etc \  
  --with-pid-dir=/var/run \  
  --with-subsys-dir=/var/run \  
  --with-mysql \  
  --with-working-dir=/opt/bacula/working \  
  --with-dump-email=$USER
```

The advantage of using the above configuration to start is that everything will be put into a single directory, which you can later delete once you have run the examples in the next chapter and learned how Bacula works. In addition, the above can be installed and run as non-root.

For the developer's convenience, I have added a **defaultconfig** script to the **examples** directory. This script contains the statements that you would normally use, and each developer/user may modify them to suit his needs. You should find additional useful examples in this directory as well.

The **--enable-conio** or **--enable-readline** options are useful because they provide a command line history, editing capability for the Console program and tab completion on various option. If you have included either option in the build, either the **termcap** or the **ncurses** package will be needed to link. On most systems, including Red Hat and SuSE, you should include the ncurses package. If Bacula's configure process finds the ncurses libraries, it will use those rather than the termcap library. On some systems, such as SuSE, the termcap library is not in the standard library directory. As a consequence, the option may be disabled or you may get an error message such as:

```
/usr/lib/gcc-lib/i586-suse-linux/3.3.1/.../ld:
cannot find -ltermcap
collect2: ld returned 1 exit status
```

while building the Bacula Console. In that case, you will need to set the **LDFLAGS** environment variable prior to building.

```
export LDFLAGS="-L/usr/lib/termcap"
```

The same library requirements apply if you wish to use the readline subroutines for command line editing, history and tab completion or if you are using a MySQL library that requires encryption. If you need encryption, you can either export the appropriate additional library options as shown above or, alternatively, you can include them directly on the `./configure` line as in:

```
LDFLAGS="-lssl -lcyrpto" \
./configure <your-options>
```

On some systems such as Mandriva, readline tends to gobble up prompts, which makes it totally useless. If this happens to you, use the `disable` option, or if you are using version 1.33 and above try using **--enable-conio** to use a built-in readline replacement. You will still need either the `termcap` or the `ncurses` library, but it is unlikely that the **conio** package will gobble up prompts.

readline is no longer supported after version 1.34. The code within Bacula remains, so it should be usable, and if users submit patches for it, we will be happy to apply them. However, due to the fact that each version of readline seems to be incompatible with previous versions, and that there are significant differences between systems, we can no longer afford to support it.

10.7 What Database to Use?

Before building Bacula you need to decide if you want to use SQLite, MySQL, or PostgreSQL. If you are not already running MySQL or PostgreSQL, you might want to start by testing with SQLite (not supported on Solaris). This will greatly simplify the setup for you because SQLite is compiled into Bacula and requires no administration. It performs well and is suitable for small to medium sized installations (maximum 10-20 machines). However, we should note that a number of users have had unexplained database corruption with SQLite. For that reason, we recommend that you install either PostgreSQL or MySQL for production work. If you wish to use MySQL as the Bacula catalog, please see the Installing and Configuring MySQL chapter of this manual. You will need to install MySQL prior to continuing with the configuration of Bacula. MySQL is a high quality database that is very efficient and is suitable for small and medium sized installation (up to 2,000,000 files per job). It is slightly more complicated than SQLite to setup and administer because it has a number of sophisticated features such as userids and passwords. It runs as a separate process, is truly professional and can manage a database of any size.

If you wish to use PostgreSQL as the Bacula catalog, please see the Installing and Configuring PostgreSQL chapter of this manual. You will need to install PostgreSQL prior to continuing with the configuration of Bacula. PostgreSQL is very similar to MySQL, though it tends to be slightly more SQL92 compliant and has many more advanced features such as transactions, stored procedures, and the such. It requires a certain knowledge to install and maintain. PostgreSQL is suitable for any sized installation (some sites have much more than 1 billion objects in the Catalog). Bacula uses many optimized PostgreSQL functions, and can run more than 10 time faster on jobs having millions of files than MySQL (Specially in during restore, accurate mode, `bvfs` queries and when the database server is not on the same host than the Director). It's possible to switch from MySQL/SQLite to PostgreSQL, but it requires some DBA knowledge.

If you wish to use SQLite as the Bacula catalog, please see Installing and Configuring SQLite chapter of this manual. SQLite is not supported on Solaris.

10.8 Quick Start

There are a number of options and important considerations given below that you can skip for the moment if you have not had any problems building Bacula with a simplified configuration as shown above.

If the `./configure` process is unable to find specific libraries (e.g. `libintl`), you should ensure that the appropriate package is installed on your system. Alternatively, if the package is installed in a non-standard location (as far as Bacula is concerned), then there is generally an option listed below (or listed with `./configure --help`) that will permit you to specify the directory that should be searched. In other cases, there are options that will permit you to disable to feature (e.g. `--disable-nls`).



If you want to dive right into it, we recommend you skip to the next chapter, and run the example program. It will teach you a lot about Bacula and as an example can be installed into a single directory (for easy removal) and run as non-root. If you have any problems or when you want to do a real installation, come back to this chapter and read the details presented below.

10.9 Configure Options

The following command line options are available for **configure** to customize your installation.

-prefix=<patch> This option is meant to allow you to direct where the architecture independent files should be placed. However, we find this a somewhat vague concept, and so we have not implemented this option other than to use any explicit prefix that you may define. If you do not explicitly specify a prefix, Bacula's configure routine will not use the default value that `./configure --help` prints. As a consequence, we suggest that you avoid it. We have provided options that allow you to explicitly specify the directories for each of the major categories of installation files.

-sbindir=<binary-path> Defines where the Bacula binary (executable) files will be placed during a **make install** command.

-sysconfdir=<config-path> Defines where the Bacula configuration files should be placed during a **make install** command. Note, for security reasons, this directory should be unique to Bacula and not read/writable by any other user/group than Bacula is running under.

-mandir=<path> Note, as of Bacula version 1.39.14, the meaning of any path specified on this option is change from prior versions. It now specifies the top level man directory. Previously the mandir specified the full path to where you wanted the man files installed. The man files will be installed in gzip'ed format under `mandir/man1` and `mandir/man8` as appropriate. For the install to succeed you must have **gzip** installed on your system.

By default, Bacula will install the Unix man pages in `/usr/share/man/man1` and `/usr/share/man/man8`. If you wish the man page to be installed in a different location, use this option to specify the path. Note, the main HTML and PDF Bacula documents are in a separate tar file that is not part of the source distribution.

-datadir=<path> If you translate Bacula or parts of Bacula into a different language you may specify the location of the po files using the **-datadir** option. You must manually install any po files as Bacula does not (yet) automatically do so.

-disable-ipv6

-enable-smartalloc This enables the inclusion of the Smartalloc orphaned buffer detection code. This option is highly recommended. Because we never build without this option, you may experience problems if it is not enabled. In this case, simply re-enable the option. We strongly recommend keeping this option enabled as it helps detect memory leaks. This configuration parameter is used while building Bacula

-enable-bat If you have Qt4 \geq 4.3.4 installed on your computer including the `libqt4` and `libqt4-devel` (`libqt4-dev` on Debian) libraries, and you want to use the Bacula Administration Tool (bat) GUI Console interface to Bacula, you must specify this option. Doing so will build everything in the **src/qt-console** directory. The build with `enable-bat` will work only with a full Bacula build (i.e. it will not work with a client-only build).

Qt4 is available on OpenSUSE 10.2, CentOS 5, Fedora, and Debian. If it is not available on your system, you can download the **depkgs-qt** package from the Bacula Source Forge download area and build it. See the `INSTALL` file in that package for more details. In particular to use the Qt4 built by **depkgs-qt** you **must** source the file **qt4-paths**.

-enable-batch-insert This option enables batch inserts of the attribute records (default) in the catalog database, which is much faster (10 times or more) than without this option for large numbers of files. However, this option will automatically be disabled if your SQL libraries are not thread safe. If you find that batch mode is not enabled on your Bacula installation, then your database most likely does not support threads.

SQLite2 is not thread safe. Batch insert cannot be enabled when using SQLite2

On most systems, MySQL, PostgreSQL and SQLite3 are thread safe.

To verify that your PostgreSQL is thread safe, you can try this (change the path to point to your particular installed libpq.a; these commands were issued on FreeBSD 6.2):

```
$ nm /usr/local/lib/libpq.a | grep PQputCopyData
00001b08 T PQputCopyData
$ nm /usr/local/lib/libpq.a | grep mutex
      U pthread_mutex_lock
      U pthread_mutex_unlock
      U pthread_mutex_init
      U pthread_mutex_lock
      U pthread_mutex_unlock
```

The above example shows a libpq that contains the required function PQputCopyData and is thread enabled (i.e. the pthread_mutex* entries). If you do not see PQputCopyData, your version of PostgreSQL is too old to allow batch insert. If you do not see the mutex entries, then thread support has not been enabled. Our tests indicate you usually need to change the configuration options and recompile/reinstall the PostgreSQL client software to get thread support.

Bacula always links to the thread safe MySQL libraries.

Running with Batch Insert turned on is recommended because it can significantly improve attribute insertion times. However, it does put a significantly larger part of the work on your SQL engine, so you may need to pay more attention to tuning it. In particular, Batch Insert can require large temporary table space, and consequently, the default location (often /tmp) may run out of space causing errors. For MySQL, the location is set in my.conf with "tmpdir". You may also want to increase the memory available to your SQL engine to further improve performance during Batch Inserts.

- enable-bwx-console** If you have wxWidgets installed on your computer and you want to use the wxWidgets GUI Console interface to Bacula, you must specify this option. Doing so will build everything in the **src/wx-console** directory. This could also be useful to users who want a GUI Console and don't want to install QT, as wxWidgets can work with GTK+, Motif or even X11 libraries.
 - enable-tray-monitor** If you have GTK installed on your computer, you run a graphical environment or a window manager compatible with the FreeDesktop system tray standard (like KDE and GNOME) and you want to use a GUI to monitor Bacula daemons, you must specify this option. Doing so will build everything in the **src/tray-monitor** directory. Note, due to restrictions on what can be linked with GPLed code, we were forced to remove the egg code that dealt with the tray icons and replace it by calls to the GTK+ API, and unfortunately, the tray icon API necessary was not implemented until GTK version 2.10 or later.
 - enable-static-tools** This option causes the linker to link the Storage daemon utility tools (**bls**, **bextract**, and **bscan**) statically. This permits using them without having the shared libraries loaded. If you have problems linking in the **src/stored** directory, make sure you have not enabled this option, or explicitly disable static linking by adding **--disable-static-tools**.
 - enable-static-fd** This option causes the make process to build a **static-bacula-fd** in addition to the standard File daemon. This static version will include statically linked libraries and is required for the Bare Metal recovery. This option is largely superseded by using **make static-bacula-fd** from within the **src/filed** directory. Also, the **--enable-client-only** option described below is useful for just building a client so that all the other parts of the program are not compiled.
- When linking a static binary, the linker needs the static versions of all the libraries that are used, so frequently users will experience linking errors when this option is used. The first thing to do is to make sure you have the static glibc library installed on your system. The second thing to do is to make sure you do not specify **-openssl** or **-with-python** on your ./configure statement as these options require additional libraries. You may be able to enable those options, but you will need to load additional static libraries.
- enable-static-sd** This option causes the make process to build a **static-bacula-sd** in addition to the standard Storage daemon. This static version will include statically linked libraries and could be useful during a Bare Metal recovery.

When linking a static binary, the linker needs the static versions of all the libraries that are used, so frequently users will experience linking errors when this option is used. The first thing to do is to make



sure you have the static glibc library installed on your system. The second thing to do is the make sure you do not specify **-openssl** or **-with-python** on your `./configure` statement as these options require additional libraries. You may be able to enable those options, but you will need to load additional static libraries.

-enable-static-dir This option causes the make process to build a **static-bacula-dir** in addition to the standard Director. This static version will include statically linked libraries and could be useful during a Bare Metal recovery.

When linking a static binary, the linker needs the static versions of all the libraries that are used, so frequently users will experience linking errors when this option is used. The first thing to do is to make sure you have the static glibc library installed on your system. The second thing to do is the make sure you do not specify **-openssl** or **-with-python** on your `./configure` statement as these options require additional libraries. You may be able to enable those options, but you will need to load additional static libraries.

-enable-static-cons This option causes the make process to build a **static-console** in addition to the standard console. This static version will include statically linked libraries and could be useful during a Bare Metal recovery.

When linking a static binary, the linker needs the static versions of all the libraries that are used, so frequently users will experience linking errors when this option is used. The first thing to do is to make sure you have the static glibc library installed on your system. The second thing to do is the make sure you do not specify **-openssl** or **-with-python** on your `./configure` statement as these options require additional libraries. You may be able to enable those options, but you will need to load additional static libraries.

-enable-client-only This option causes the make process to build only the File daemon and the libraries that it needs. None of the other daemons, storage tools, nor the console will be built. Likewise a **make install** will then only install the File daemon. To cause all daemons to be built, you will need to do a configuration without this option. This option greatly facilitates building a Client on a client only machine.

When linking a static binary, the linker needs the static versions of all the libraries that are used, so frequently users will experience linking errors when this option is used. The first thing to do is to make sure you have the static glibc library installed on your system. The second thing to do is the make sure you do not specify **-openssl** or **-with-python** on your `./configure` statement as these options require additional libraries. You may be able to enable those options, but you will need to load additional static libraries.

-enable-build-dir This option causes the make process to build the Director and the Director's tools. By default, this option is on, but you may turn it off by using **-disable-build-dir** to prevent the Director from being built.

-enable-build-stored This option causes the make process to build the Storage daemon. By default, this option is on, but you may turn it off by using **-disable-build-stored** to prevent the Storage daemon from being built.

-enable-largefile This option (default) causes Bacula to be built with 64 bit file address support if it is available on your system. This permits Bacula to read and write files greater than 2 GBytes in size. You may disable this feature and revert to 32 bit file addresses by using **--disable-largefile**.

-disable-nls By default, Bacula uses the GNU Native Language Support (NLS) libraries. On some machines, these libraries may not be present or may not function correctly (especially on non-Linux implementations). In such cases, you may specify **-disable-nls** to disable use of those libraries. In such a case, Bacula will revert to using English.

-disable-ipv6 By default, Bacula enables IPv6 protocol. On some systems, the files for IPv6 may exist, but the functionality could be turned off in the kernel. In that case, in order to correctly build Bacula, you will explicitly need to use this option so that Bacula does not attempt to reference OS function calls that do not exist.

-with-sqlite3=<sqlite3-path> This enables use of the SQLite version 3.x database. The **sqlite3-path** is not normally specified as Bacula looks for the necessary components in a standard location (**dependencies/sqlite3**). See Installing and Configuring SQLite chapter of this manual for more details. SQLite3 is not supported on Solaris.



-with-mysql=<mysql-path> This enables building of the Catalog services for Bacula. It assumes that MySQL is running on your system, and expects it to be installed in the **mysql-path** that you specify. Normally, if MySQL is installed in a standard system location, you can simply use **-with-mysql** with no path specification. If you do use this option, please proceed to installing MySQL in the Installing and Configuring MySQL chapter before proceeding with the configuration.

See the note below under the **-with-postgresql** item.

-with-postgresql=<path> This provides an explicit path to the PostgreSQL libraries if Bacula cannot find it by default. Normally to build with PostgreSQL, you would simply use **-with-postgresql**.

Note, for Bacula to be configured properly, you must specify one of the four database options supported. That is: **-with-sqlite**, **-with-sqlite3**, **-with-mysql**, or **-with-postgresql**, otherwise the `./configure` will fail.

-with-openssl=<path> This configuration option is necessary if you want to enable TLS (ssl), which encrypts the communications within Bacula or if you want to use File Daemon PKI data encryption. Normally, the **path** specification is not necessary since the configuration searches for the OpenSSL libraries in standard system locations. However, you must ensure that all the libraries are loaded including **libssl-dev** or the equivalent on your system. Enabling OpenSSL in Bacula permits secure communications between the daemons and/or data encryption in the File daemon. For more information on using TLS, please see the Bacula TLS – Communications Encryption chapter of this manual. For more information on using PKI data encryption, please see the Bacula PKI – Data Encryption chapter of this manual.

If you get errors linking, you need to load the development libraries, or you need to disable SSL by setting `without-openssl`.

-with-python=<path> This option enables Bacula support for Python. If no path is supplied, configure will search the standard library locations for Python 2.2, 2.3, 2.4, or 2.5. If it cannot find the library, you will need to supply a path to your Python library directory. Please see the **Python Scripting** chapter (chapter 1 on page 1) of the Bacula Community Misc Manual for the details of using Python scripting.

-with-libintl-prefix=<DIR> This option may be used to tell Bacula to search `DIR/include` and `DIR/lib` for the libintl headers and libraries needed for Native Language Support (NLS).

-enable-conio Tells Bacula to enable building the small, light weight readline replacement routine. It is generally much easier to configure than readline, although, like readline, it needs either the `termcap` or `ncurses` library.

-with-readline=<readline-path> Tells Bacula where **readline** is installed. Normally, Bacula will find readline if it is in a standard library. If it is not found and no **-with-readline** is specified, readline will be disabled. This option affects the Bacula build. Readline provides the Console program with a command line history and editing capability and is no longer supported, so you are on your own if you have problems.

-enable-readline Tells Bacula to enable readline support. It is normally disabled due to the large number of configuration problems and the fact that the package seems to change in incompatible ways from version to version.

-with-tcp-wrappers=<path> This specifies that you want TCP wrappers (`man hosts_access(5)`) compiled in. The path is optional since Bacula will normally find the libraries in the standard locations. This option affects the Bacula build. In specifying your restrictions in the `/etc/hosts.allow` or `/etc/hosts.deny` files, do not use the **twist** option (`hosts_options(5)`) or the Bacula process will be terminated. Note, when setting up your `/etc/hosts.allow` or `/etc/hosts.deny`, you must identify the Bacula daemon in question with the name you give it in your conf file rather than the name of the executable.

For more information on configuring and testing TCP wrappers, please see the Configuring and Testing TCP Wrappers section in the Security Chapter.

On SuSE, the libwrappers libraries needed to link Bacula are contained in the `tcpd-devel` package. On Red Hat, the package is named `tcp_wrappers`.

-with-archivedir=<path> The directory used for disk-based backups. Default value is `/tmp`. This parameter sets the default values in the `bacula-dir.conf` and `bacula-sd.conf` configuration files. For



example, it sets the Where directive for the default restore job and the Archive Device directive for the FileStorage device.

This option is designed primarily for use in regression testing. Most users can safely ignore this option.

- with-working-dir=<working-directory-path>** This option is mandatory and specifies a directory into which Bacula may safely place files that will remain between Bacula executions. For example, if the internal database is used, Bacula will keep those files in this directory. This option is only used to modify the daemon configuration files. You may also accomplish the same thing by directly editing them later. The working directory is not automatically created by the install process, so you must ensure that it exists before using Bacula for the first time.
- with-baseport=<port=number>** In order to run, Bacula needs three TCP/IP ports (one for the Bacula Console, one for the Storage daemon, and one for the File daemon). The **--with-baseport** option will automatically assign three ports beginning at the base port address specified. You may also change the port number in the resulting configuration files. However, you need to take care that the numbers correspond correctly in each of the three daemon configuration files. The default base port is 9101, which assigns ports 9101 through 9103. These ports (9101, 9102, and 9103) have been officially assigned to Bacula by IANA. This option is only used to modify the daemon configuration files. You may also accomplish the same thing by directly editing them later.
- with-dump-email=<email-address>** This option specifies the email address where any core dumps should be set. This option is normally only used by developers.
- with-pid-dir=<PATH>** This specifies where Bacula should place the process id file during execution. The default is: **/var/run**. This directory is not created by the install process, so you must ensure that it exists before using Bacula the first time.
- with-subsys-dir=<PATH>** This specifies where Bacula should place the subsystem lock file during execution. The default is **/var/run/subsys**. Please make sure that you do not specify the same directory for this directory and for the **sbindir** directory. This directory is used only within the autostart scripts. The subsys directory is not created by the Bacula install, so you must be sure to create it before using Bacula.
- with-dir-password=<Password>** This option allows you to specify the password used to access the Director (normally from the Console program). If it is not specified, configure will automatically create a random password.
- with-fd-password=<Password>** This option allows you to specify the password used to access the File daemon (normally called from the Director). If it is not specified, configure will automatically create a random password.
- with-sd-password=<Password>** This option allows you to specify the password used to access the Storage daemon (normally called from the Director). If it is not specified, configure will automatically create a random password.
- with-dir-user=<User>** This option allows you to specify the Userid used to run the Director. The Director must be started as root, but doesn't need to run as root, and after doing preliminary initializations, it can "drop" to the UserId specified on this option. If you specify this option, you must create the User prior to running **make install**, because the working directory owner will be set to **User**.
- with-dir-group=<Group>** This option allows you to specify the GroupId used to run the Director. The Director must be started as root, but doesn't need to run as root, and after doing preliminary initializations, it can "drop" to the GroupId specified on this option. If you specify this option, you must create the Group prior to running **make install**, because the working directory group will be set to **Group**.
- with-sd-user=<User>** This option allows you to specify the Userid used to run the Storage daemon. The Storage daemon must be started as root, but doesn't need to run as root, and after doing preliminary initializations, it can "drop" to the UserId specified on this option. If you use this option, you will need to take care that the Storage daemon has access to all the devices (tape drives, ...) that it needs.



- with-sd-group=<Group>** This option allows you to specify the GroupId used to run the Storage daemon. The Storage daemon must be started as root, but doesn't need to run as root, and after doing preliminary initializations, it can "drop" to the GroupId specified on this option.
- with-fd-user=<User>** This option allows you to specify the Userid used to run the File daemon. The File daemon must be started as root, and in most cases, it needs to run as root, so this option is used only in very special cases, after doing preliminary initializations, it can "drop" to the UserId specified on this option.
- with-fd-group=<Group>** This option allows you to specify the GroupId used to run the File daemon. The File daemon must be started as root, and in most cases, it must be run as root, however, after doing preliminary initializations, it can "drop" to the GroupId specified on this option.
- with-mon-dir-password=<Password>** This option allows you to specify the password used to access the Directory from the monitor. If it is not specified, configure will automatically create a random password.
- with-mon-fd-password=<Password>** This option allows you to specify the password used to access the File daemon from the Monitor. If it is not specified, configure will automatically create a random password.
- with-mon-sd-password=<Password>** This option allows you to specify the password used to access the Storage daemon from the Monitor. If it is not specified, configure will automatically create a random password.
- with-db-name=<database-name>** This option allows you to specify the database name to be used in the conf files. The default is bacula.
- with-db-user=<database-user>** This option allows you to specify the database user name to be used in the conf files. The default is bacula.

Note, many other options are presented when you do a `./configure --help`, but they are not implemented.

10.10 Recommended Options for Most Systems

For most systems, we recommend starting with the following options:

```
./configure \
--enable-smartalloc \
--sbindir=/opt/bacula/bin \
--sysconfdir=/opt/bacula/etc \
--with-pid-dir=/opt/bacula/working \
--with-subsys-dir=/opt/bacula/working \
--with-working-dir=/opt/bacula/working
```

If you want to install Bacula in an installation directory rather than run it out of the build directory (as developers will do most of the time), you should also include the `--sbindir` and `--sysconfdir` options with appropriate paths. Neither are necessary if you do not use "make install" as is the case for most development work. The install process will create the `sbindir` and `sysconfdir` if they do not exist, but it will not automatically create the `pid-dir`, `subsys-dir`, or `working-dir`, so you must ensure that they exist before running Bacula for the first time.

10.11 Red Hat

Using SQLite:

```
CFLAGS="-g -Wall" ./configure \
--sbindir=/opt/bacula/bin \
--sysconfdir=/opt/bacula/etc \
--enable-smartalloc \
--with-sqlite=$HOME/bacula/depkgs/sqlite \
--with-working-dir=/opt/bacula/working \
--with-pid-dir=/opt/bacula/working \
--with-subsys-dir=/opt/bacula/working \
--enable-bat \
--enable-readline
```



or

```
CFLAGS="-g -Wall" ./configure \
  --sbindir=/opt/bacula/bin \
  --sysconfdir=/opt/bacula/etc \
  --enable-smartalloc \
  --with-mysql \
  --with-working-dir=/opt/bacula/working \
  --with-pid-dir=/opt/bacula/working \
  --with-subsys-dir=/opt/bacula/working \
  --enable-readline
```

or finally, a completely traditional Red Hat Linux install, which we do not recommend, because it make it harder to backup Bacula for disaster recovery purposes:

```
CFLAGS="-g -Wall" ./configure \
  --sbindir=/usr/sbin \
  --sysconfdir=/etc/bacula \
  --with-scriptdir=/etc/bacula \
  --enable-smartalloc \
  --enable-bat \
  --with-mysql \
  --with-working-dir=/var/bacula \
  --with-pid-dir=/var/run \
  --enable-readline
```

Note, Bacula assumes that /var/bacula, /var/run, and /var/lock/subsys exist so it will not automatically create them during the install process.

10.12 Solaris

To build Bacula from source, you will need the following installed on your system (they are not by default): libiconv, gcc 3.3.2, stdc++, libgcc (for stdc++ and gcc_s libraries), make 3.8 or later.

You will probably also need to: Add /usr/local/bin to PATH and Add /usr/ccs/bin to PATH for ar.

It is possible to build Bacula on Solaris with the Solaris compiler, but we recommend using GNU C++ if possible.

A typical configuration command might look like:

```
#!/bin/sh
CFLAGS="-g" ./configure \
  --sbindir=/opt/bacula/bin \
  --sysconfdir=/opt/bacula/etc \
  --with-mysql \
  --enable-smartalloc \
  --with-pid-dir=/opt/bacula/working \
  --with-subsys-dir=/opt/bacula/working \
  --with-working-dir=/opt/bacula/working
```

Note, you may need to install the following packages to build Bacula from source:

```
SUNWbinutils,
SUNWarc,
SUNWhea,
SUNWGcc,
SUNWGnutls
SUNWGnutls-devel
SUNWGmake
SUNWgccruntime
SUNWlibgcrypt
SUNWzlib
SUNWzlibs
SUNWreadline
SUNWbinutilsS
SUNWGmakeS
SUNWlibm
```

```
export
```

```
PATH=/usr/bin:./usr/ccs/bin:/etc:/usr/openwin/bin:/usr/local/bin:/usr/sfw/bin:/opt/sfw/bin:/usr/ucb:/usr/sbin
```

If you have installed special software not normally in the Solaris libraries, such as OpenSSL, or the packages shown above, then you may need to add **/usr/sfw/lib** to the library search path. Probably the simplest way to do so is to run:

```
setenv LD_FLAGS "-L/usr/sfw/lib -R/usr/sfw/lib"
```

Prior to running the `./configure` command.

Alternatively, you can set the `LD_LIBRARY_PATH` and/or the `LD_RUN_PATH` environment variables appropriately.

It is also possible to use the `crle` program to set the library search path. However, this should be used with caution.

10.13 FreeBSD

Please see: *The FreeBSD Diary* for a detailed description on how to make Bacula work on your system. In addition, users of FreeBSD prior to 4.9-STABLE dated Mon Dec 29 15:18:01 2003 UTC who plan to use tape devices, please see the **Tape Testing** chapter (chapter 3.3.6 on page 41) of the Bacula Community Problem Resolution Guide for **important** information on how to configure your tape drive for compatibility with Bacula.

If you are using Bacula with MySQL, you should take care to compile MySQL with FreeBSD native threads rather than LinuxThreads, since Bacula is normally built with FreeBSD native threads rather than LinuxThreads. Mixing the two will probably not work.

10.14 Win32

To install the binary Win32 version of the File daemon please see the Win32 Installation Chapter in this document.

10.15 One File Configure Script

The following script could be used if you want to put everything in a single directory (except for the working directory):

```
#!/bin/sh
CFLAGS="-g -Wall" \
./configure \
  --sbindir=$HOME/bacula/bin \
  --sysconfdir=$HOME/bacula/bin \
  --mandir=$HOME/bacula/bin \
  --enable-smartalloc \
  --enable-bat \
  --with-pid-dir=$HOME/bacula/bin/working \
  --with-subsys-dir=$HOME/bacula/bin/working \
  --with-mysql \
  --with-working-dir=$HOME/bacula/bin/working \
  --with-dump-email=$USER@your-site.com \
  --with-job-email=$USER@your-site.com \
  --with-smtp-host=mail.your-site.com
exit 0
```

You may also want to put the following entries in your `/etc/services` file as it will make viewing the connections made by Bacula easier to recognize (i.e. `netstat -a`):

```
bacula-dir    9101/tcp
bacula-fd     9102/tcp
bacula-sd     9103/tcp
```

10.16 Installing Bacula

Before setting up your configuration files, you will want to install Bacula in its final location. Simply enter:

```
make install
```

If you have previously installed Bacula, the old binaries will be overwritten, but the old configuration files will remain unchanged, and the "new" configuration files will be appended with a `.new`. Generally if you have previously installed and run Bacula you will want to discard or ignore the configuration files with the appended `.new`.



10.17 Building a File Daemon or Client

If you run the Director and the Storage daemon on one machine and you wish to back up another machine, you must have a copy of the File daemon for that machine. If the machine and the Operating System are identical, you can simply copy the Bacula File daemon binary file **bacula-fd** as well as its configuration file **bacula-fd.conf** then modify the name and password in the conf file to be unique. Be sure to make corresponding additions to the Director's configuration file (**bacula-dir.conf**).

If the architecture or the OS level are different, you will need to build a File daemon on the Client machine. To do so, you can use the same **./configure** command as you did for your main program, starting either from a fresh copy of the source tree, or using **make distclean** before the **./configure**.

Since the File daemon does not access the Catalog database, you can remove the **--with-mysql** or **--with-sqlite** options, then add **--enable-client-only**. This will compile only the necessary libraries and the client programs and thus avoids the necessity of installing one or another of those database programs to build the File daemon. With the above option, you simply enter **make** and just the client will be built.

10.18 Auto Starting the Daemons

If you wish the daemons to be automatically started and stopped when your system is booted (a good idea), one more step is necessary. First, the **./configure** process must recognize your system – that is it must be a supported platform and not **unknown**, then you must install the platform dependent files by doing:

```
(become root)
make install-autostart
```

Please note, that the auto-start feature is implemented only on systems that we officially support (currently, FreeBSD, Red Hat/Fedora Linux, and Solaris), and has only been fully tested on Fedora Linux.

The **make install-autostart** will cause the appropriate startup scripts to be installed with the necessary symbolic links. On Red Hat/Fedora Linux systems, these scripts reside in **/etc/rc.d/init.d/bacula-dir**, **/etc/rc.d/init.d/bacula-fd**, and **/etc/rc.d/init.d/bacula-sd**. However the exact location depends on what operating system you are using.

If you only wish to install the File daemon, you may do so with:

```
make install-autostart-fd
```

10.19 Other Make Notes

To simply build a new executable in any directory, enter:

```
make
```

To clean out all the objects and binaries (including the files named 1, 2, or 3, which are development temporary files), enter:

```
make clean
```

To really clean out everything for distribution, enter:

```
make distclean
```

note, this cleans out the Makefiles and is normally done from the top level directory to prepare for distribution of the source. To recover from this state, you must redo the **./configure** in the top level directory, since all the Makefiles will be deleted.

To add a new file in a subdirectory, edit the Makefile.in in that directory, then simply do a **make**. In most cases, the make will rebuild the Makefile from the new Makefile.in. In some case, you may need to issue the **make** a second time. In extreme cases, cd to the top level directory and enter: **make Makefiles**.

To add dependencies:

```
make depend
```

The **make depend** appends the header file dependencies for each of the object files to Makefile and Makefile.in. This command should be done in each directory where you change the dependencies. Normally, it only needs to be run when you add or delete source or header files. **make depend** is normally automatically invoked during the configuration process.

To install:



```
make install
```

This is not normally done if you are developing Bacula, but is used if you are going to run it to backup your system.

After doing a **make install** the following files will be installed on your system (more or less). The exact files and location (directory) for each file depends on your **./configure** command (e.g. if you are using SQLite instead of MySQL, some of the files will be different).

NOTE: it is quite probable that this list is out of date. But it is a starting point.

```
bacula
bacula-dir
bacula-dir.conf
bacula-fd
bacula-fd.conf
bacula-sd
bacula-sd.conf
bacula-tray-monitor
tray-monitor.conf
bextract
bls
bscan
btape
btraceback
btraceback.gdb
bconsole
bconsole.conf
create_mysql_database
dbcheck
delete_catalog_backup
drop_bacula_tables
drop_mysql_tables
make_bacula_tables
make_catalog_backup
make_mysql_tables
mtx-changer
query.sql
bsmtp
startmysql
stopmysql
bwx-console
bwx-console.conf
9 man pages
```

10.20 Installing Tray Monitor

The Tray Monitor is already installed if you used the **--enable-tray-monitor** configure option and ran **make install**.

As you don't run your graphical environment as root (if you do, you should change that bad habit), don't forget to allow your user to read **tray-monitor.conf**, and to execute **bacula-tray-monitor** (this is not a security issue).

Then log into your graphical environment (KDE, GNOME or something else), run **bacula-tray-monitor** as your user, and see if a cassette icon appears somewhere on the screen, usually on the task bar. If it doesn't, follow the instructions below related to your environment or window manager.

10.20.1 GNOME

System tray, or notification area if you use the GNOME terminology, has been supported in GNOME since version 2.2. To activate it, right-click on one of your panels, open the menu **Add to this Panel**, then **Utility** and finally click on **Notification Area**.

10.20.2 KDE

System tray has been supported in KDE since version 3.1. To activate it, right-click on one of your panels, open the menu **Add**, then **Applet** and finally click on **System Tray**.



10.20.3 Other Window Managers

Read the documentation to know if the freedesktop system tray standard is supported by your window manager, and if applicable, how to activate it.

10.21 Modifying the Bacula Configuration Files

See the chapter *Configuring Bacula* in this manual for instructions on how to set Bacula configuration files.



Chapter 11

Critical Items to Implement Before Production

We recommend you take your time before implementing a production a Bacula backup system since Bacula is a rather complex program, and if you make a mistake, you may suddenly find that you cannot restore your files in case of a disaster. This is especially true if you have not previously used a major backup product. If you follow the instructions in this chapter, you will have covered most of the major problems that can occur. It goes without saying that if you ever find that we have left out an important point, please inform us, so that we can document it to the benefit of everyone.

11.1 Critical Items

The following assumes that you have installed Bacula, you more or less understand it, you have at least worked through the tutorial or have equivalent experience, and that you have set up a basic production configuration. If you haven't done the above, please do so and then come back here. The following is a sort of checklist that points with perhaps a brief explanation of why you should do it. In most cases, you will find the details elsewhere in the manual. The order is more or less the order you would use in setting up a production system (if you already are in production, use the checklist anyway).

- Test your tape drive for compatibility with Bacula by using the test command in the See the **btape** section (section 1.9 on page 13) of the Bacula Community Utility programs.
- Better than doing the above is to walk through the nine steps in the **Tape Testing** chapter (chapter 3 on page 31) of the Bacula Community Problem Resolution Guide. It may take you a bit of time, but it will eliminate surprises.
- Test the end of tape handling of your tape drive by using the **fill** command in the **btape program** section (section 1.9 on page 13) (Part of the Bacula Community Utility programs)
- If you are using a Linux 2.4 kernel, make sure that `/lib/tls` is disabled. Bacula does not work with this library. See the second point under Supported Operating Systems.
- Do at least one restore of files. If you backup multiple OS types (Linux, Solaris, HP, MacOS, FreeBSD, Win32, ...), restore files from each system type. The Restoring Files chapter shows you how.
- Write a bootstrap file to a separate system for each backup job. The Write Bootstrap directive is described in the Director Configuration chapter of the manual, and more details are available in the Bootstrap File chapter. Also, the default `bacula-dir.conf` comes with a Write Bootstrap directive defined. This allows you to recover the state of your system as of the last backup.
- Backup your catalog. An example of this is found in the default `bacula-dir.conf` file. The backup script is installed by default and should handle any database, though you may want to make your own local modifications. See also Backing Up Your Bacula Database - Security Considerations for more information.
- Write a bootstrap file for the catalog. An example of this is found in the default `bacula-dir.conf` file. This will allow you to quickly restore your catalog in the event it is wiped out – otherwise it is many excruciating hours of work.



- Make a copy of the `bacula-dir.conf`, `bacula-sd.conf`, and `bacula-fd.conf` files that you are using on your server. Put it in a safe place (on another machine) as these files can be difficult to reconstruct if your server dies.
- Make a Bacula Rescue CDROM! See the Disaster Recovery Using a Bacula Rescue CDROM chapter. It is trivial to make such a CDROM, and it can make system recovery in the event of a lost hard disk infinitely easier.
- Bacula assumes all filenames are in UTF-8 format. This is important when saving the filenames to the catalog. For Win32 machine, Bacula will automatically convert from Unicode to UTF-8, but on Unix, Linux, *BSD, and MacOS X machines, you must explicitly ensure that your locale is set properly. Typically this means that the **LANG** environment variable must end in **.UTF-8**. A full example is **en_US.UTF-8**. The exact syntax may vary a bit from OS to OS, and exactly how you define it will also vary.

On most modern Win32 machines, you can edit the conf files with **notepad** and choose output encoding UTF-8.

11.2 Recommended Items

Although these items may not be critical, they are recommended and will help you avoid problems.

- Read the Quick Start Guide to Bacula
- After installing and experimenting with Bacula, read and work carefully through the examples in the Tutorial chapter of this manual.
- Learn what each of the **Bacula Utility Programs** (chapter 1 on page 3) does.
- Set up reasonable retention periods so that your catalog does not grow to be too big. See the following three chapters:
Recycling your Volumes,
Basic Volume Management,
Using Pools to Manage Volumes.
- Perform a bare metal recovery using the Bacula Rescue CDROM. See the Disaster Recovery Using a Bacula Rescue CDROM chapter.

If you absolutely must implement a system where you write a different tape each night and take it offsite in the morning. We recommend that you do several things:

- Write a bootstrap file of your backed up data and a bootstrap file of your catalog backup to a floppy disk or a CDROM, and take that with the tape. If this is not possible, try to write those files to another computer or offsite computer, or send them as email to a friend. If none of that is possible, at least print the bootstrap files and take that offsite with the tape. Having the bootstrap files will make recovery much easier.
- It is better not to force Bacula to load a particular tape each day. Instead, let Bacula choose the tape. If you need to know what tape to mount, you can print a list of recycled and appendable tapes daily, and select any tape from that list. Bacula may propose a particular tape for use that it considers optimal, but it will accept any valid tape from the correct pool.



Chapter 12

A Brief Tutorial

This chapter will guide you through running Bacula. To do so, we assume you have installed Bacula, possibly in a single file as shown in the previous chapter, in which case, you can run Bacula as non-root for these tests. However, we assume that you have not changed the .conf files. If you have modified the .conf files, please go back and uninstall Bacula, then reinstall it, but do not make any changes. The examples in this chapter use the default configuration files, and will write the volumes to disk in your `/tmp` directory, in addition, the data backed up will be the source directory where you built Bacula. As a consequence, you can run all the Bacula daemons for these tests as non-root. Please note, in production, your File daemon(s) must run as root. See the Security chapter for more information on this subject.

The general flow of running Bacula is:

1. `cd <install-directory>`
2. Start the Database (if using MySQL or PostgreSQL)
3. Start the Daemons with `./bacula start`
4. Start the Console program to interact with the Director
5. Run a job
6. When the Volume fills, unmount the Volume, if it is a tape, label a new one, and continue running. In this chapter, we will write only to disk files so you won't need to worry about tapes for the moment.
7. Test recovering some files from the Volume just written to ensure the backup is good and that you know how to recover. Better test before disaster strikes
8. Add a second client.

Each of these steps is described in more detail below.

12.1 Before Running Bacula

Before running Bacula for the first time in production, we recommend that you run the `test` command in the `btape` program as described in the **Utility Program** chapter (chapter 1.9 on page 13) of the Bacula Community Utility programs. This will help ensure that Bacula functions correctly with your tape drive. If you have a modern HP, Sony, or Quantum DDS or DLT tape drive running on Linux or Solaris, you can probably skip this test as Bacula is well tested with these drives and systems. For all other cases, you are **strongly** encouraged to run the test before continuing. `btape` also has a `fill` command that attempts to duplicate what Bacula does when filling a tape and writing on the next tape. You should consider trying this command as well, but be forewarned, it can take hours (about four hours on my drive) to fill a large capacity tape.

12.2 Starting the Database

If you are using MySQL or PostgreSQL as the Bacula database, you should start it before you attempt to run a job to avoid getting error messages from Bacula when it starts. The scripts `startmysql` and `stopmysql` are what I (Kern) use to start and stop my local MySQL. Note, if you are using SQLite, you will not want



to use **startmysql** or **stopmysql**. If you are running this in production, you will probably want to find some way to automatically start MySQL or PostgreSQL after each system reboot.

If you are using SQLite (i.e. you specified the **--with-sqlite=xxx** option on the **./configure** command, you need do nothing. SQLite is automatically started by **Bacula**.

12.3 Starting the Daemons

Assuming you have built from source or have installed the rpms, to start the three daemons, from your installation directory, simply enter:

```
./bacula start
```

The **bacula** script starts the Storage daemon, the File daemon, and the Director daemon, which all normally run as daemons in the background. If you are using the autostart feature of Bacula, your daemons will either be automatically started on reboot, or you can control them individually with the files **bacula-dir**, **bacula-fd**, and **bacula-sd**, which are usually located in **/etc/init.d**, though the actual location is system dependent. Some distributions may do this differently.

Note, on Windows, currently only the File daemon is ported, and it must be started differently. Please see the Windows Version of Bacula Chapter of this manual.

The rpm packages configure the daemons to run as **user=root** and **group=bacula**. The rpm installation also creates the group **bacula** if it does not exist on the system. Any users that you add to the group **bacula** will have access to files created by the daemons. To disable or alter this behavior edit the daemon startup scripts:

- **/etc/bacula/bacula**
- **/etc/init.d/bacula-dir**
- **/etc/init.d/bacula-sd**
- **/etc/init.d/bacula-fd**

and then restart as noted above.

The installation chapter of this manual explains how you can install scripts that will automatically restart the daemons when the system starts.

12.4 Using the Director to Query and Start Jobs

To communicate with the director and to query the state of Bacula or run jobs, from the top level directory, simply enter:

```
./bconsole
```

Alternatively to running the command line console, if you have Qt4 installed and used the **--enable-bat** on the configure command, you may use the Bacula Administration Tool (**bat**):

```
./bat
```

Which has a graphical interface, and many more features than **bconsole**.

Two other possibilities are to run the GNOME console **bgnome-console** or the wxWidgets program **bw-console**.

For simplicity, here we will describe only the **./bconsole** program. Most of what is described here applies equally well to **./bat**, **./bgnome-console**, and to **bw-console**.

The **./bconsole** runs the Bacula Console program, which connects to the Director daemon. Since Bacula is a network program, you can run the Console program anywhere on your network. Most frequently, however, one runs it on the same machine as the Director. Normally, the Console program will print something similar to the following:

```
[kern@polymatou bin]$ ./bconsole
Connecting to Director lpmatou:9101
1000 OK: HeadMan Version: 2.1.8 (14 May 2007)
*
```

the asterisk is the console command prompt.

Type **help** to see a list of available commands:



```

*help
Command   Description
=====   =====
add       add media to a pool
autodisplay autodisplay [on|off] -- console messages
automount automount [on|off] -- after label
cancel    cancel [<jobid=nnn> | <job=name>] -- cancel a job
create    create DB Pool from resource
delete    delete [pool=<pool-name> | media volume=<volume-name>]
disable   disable <job=name> -- disable a job
enable    enable <job=name> -- enable a job
estimate  performs FileSet estimate, listing gives full listing
exit      exit = quit
gui       gui [on|off] -- non-interactive gui mode
help      print this command
list      list [pools | jobs | jobtotals | media <pool=pool-name> |
files <jobid=nn>]; from catalog
label     label a tape
llist     full or long list like list command
memory    print current memory usage
messages  messages
mount     mount <storage-name>
prune     prune expired records from catalog
purge     purge records from catalog
python    python control commands
quit      quit
query     query catalog
restore   restore files
relabel   relabel a tape
release   release <storage-name>
reload    reload conf file
run       run <job-name>
status    status [[slots] storage | dir | client]=<name>
setdebug  sets debug level
setip     sets new client address -- if authorized
show      show (resource records) [jobs | pools | ... | all]
sqlquery  use SQL to query catalog
time      print current time
trace     turn on/off trace to file
unmount   unmount <storage-name>
umount    umount <storage-name> for old-time Unix guys
update    update Volume, Pool or slots
use       use catalog xxx
var       does variable expansion
version   print Director version
wait      wait until no jobs are running [<jobname=name> | <jobid=nnn> | <ujobid=complete_name>]
*

```

Details of the console program's commands are explained in the **Console** chapter (chapter 1 on page 1) of the Bacula Community Console Manual.

12.5 Running a Job

At this point, we assume you have done the following:

- Configured Bacula with **./configure --your-options**
- Built Bacula using **make**
- Installed Bacula using **make install**
- Have created your database with, for example, **./create_sqlite_database**
- Have created the Bacula database tables with, **./make_bacula_tables**
- Have possibly edited your **bacula-dir.conf** file to personalize it a bit. BE CAREFUL! if you change the Director's name or password, you will need to make similar modifications in the other .conf files. For the moment it is probably better to make no changes.
- You have started Bacula with **./bacula start**
- You have invoked the Console program with **./bconsole**



Furthermore, we assume for the moment you are using the default configuration files. At this point, enter the following command:

```
show filesets
```

and you should get something similar to:

```
FileSet: name=Full Set
  O M
  N
  I /home/kern/bacula/regress/build
  N
  E /proc
  E /tmp
  E /.journal
  E /.fsck
  N
FileSet: name=Catalog
  O M
  N
  I /home/kern/bacula/regress/working/bacula.sql
  N
```

This is a pre-defined **FileSet** that will backup the Bacula source directory. The actual directory names printed should correspond to your system configuration. For testing purposes, we have chosen a directory of moderate size (about 40 Megabytes) and complexity without being too big. The FileSet **Catalog** is used for backing up Bacula's catalog and is not of interest to us for the moment. The **I** entries are the files or directories that will be included in the backup and the **E** are those that will be excluded, and the **O** entries are the options specified for the FileSet. You can change what is backed up by editing **bacula-dir.conf** and changing the **File =** line in the **FileSet** resource.

Now is the time to run your first backup job. We are going to backup your Bacula source directory to a File Volume in your **/tmp** directory just to show you how easy it is. Now enter:

```
status dir
```

and you should get the following output:

```
rufus-dir Version: 1.30 (28 April 2003)
Daemon started 28-Apr-2003 14:03, 0 Jobs run.
Console connected at 28-Apr-2003 14:03
No jobs are running.
Level      Type      Scheduled      Name
=====
Incremental Backup  29-Apr-2003 01:05 Client1
Full       Backup  29-Apr-2003 01:10 BackupCatalog
=====
```

where the times and the Director's name will be different according to your setup. This shows that an Incremental job is scheduled to run for the Job **Client1** at 1:05am and that at 1:10, a **BackupCatalog** is scheduled to run. Note, you should probably change the name **Client1** to be the name of your machine, if not, when you add additional clients, it will be very confusing. For my real machine, I use **Rufus** rather than **Client1** as in this example.

Now enter:

```
status client
```

and you should get something like:

```
The defined Client resources are:
  1: rufus-fd
Item 1 selected automatically.
Connecting to Client rufus-fd at rufus:8102
rufus-fd Version: 1.30 (28 April 2003)
Daemon started 28-Apr-2003 14:03, 0 Jobs run.
Director connected at: 28-Apr-2003 14:14
No jobs running.
=====
```

In this case, the client is named **rufus-fd** your name will be different, but the line beginning with **rufus-fd Version ...** is printed by your File daemon, so we are now sure it is up and running. Finally do the same for your Storage daemon with:



```
status storage
```

and you should get:

```
The defined Storage resources are:
  1: File
Item 1 selected automatically.
Connecting to Storage daemon File at rufus:8103
rufus-sd Version: 1.30 (28 April 2003)
Daemon started 28-Apr-2003 14:03, 0 Jobs run.
Device /tmp is not open.
No jobs running.
====
```

You will notice that the default Storage daemon device is named **File** and that it will use device **/tmp**, which is not currently open.

Now, let's actually run a job with:

```
run
```

you should get the following output:

```
Using default Catalog name=MyCatalog DB=bacula
A job name must be specified.
The defined Job resources are:
  1: Client1
  2: BackupCatalog
  3: RestoreFiles
Select Job resource (1-3):
```

Here, Bacula has listed the three different Jobs that you can run, and you should choose number **1** and type enter, at which point you will get:

```
Run Backup job
JobName: Client1
FileSet: Full Set
Level: Incremental
Client: rufus-fd
Storage: File
Pool: Default
When: 2003-04-28 14:18:57
OK to run? (yes/mod/no):
```

At this point, take some time to look carefully at what is printed and understand it. It is asking you if it is OK to run a job named **Client1** with FileSet **Full Set** (we listed above) as an Incremental job on your Client (your client name will be different), and to use Storage **File** and Pool **Default**, and finally, it wants to run it now (the current time should be displayed by your console).

Here we have the choice to run (**yes**), to modify one or more of the above parameters (**mod**), or to not run the job (**no**). Please enter **yes**, at which point you should immediately get the command prompt (an asterisk). If you wait a few seconds, then enter the command **messages** you will get back something like:

```
28-Apr-2003 14:22 rufus-dir: Last FULL backup time not found. Doing
      FULL backup.
28-Apr-2003 14:22 rufus-dir: Start Backup JobId 1,
      Job=Client1.2003-04-28_14.22.33
28-Apr-2003 14:22 rufus-sd: Job Client1.2003-04-28_14.22.33 waiting.
      Cannot find any appendable volumes.
Please use the "label" command to create a new Volume for:
  Storage: FileStorage
  Media type: File
  Pool: Default
```

The first message, indicates that no previous Full backup was done, so Bacula is upgrading our Incremental job to a Full backup (this is normal). The second message indicates that the job started with JobId 1., and the third message tells us that Bacula cannot find any Volumes in the Pool for writing the output. This is normal because we have not yet created (labeled) any Volumes. Bacula indicates to you all the details of the volume it needs.

At this point, the job is **BLOCKED** waiting for a Volume. You can check this if you want by doing a **status dir**. In order to continue, we must create a Volume that Bacula can write on. We do so with:



label

and Bacula will print:

```
The defined Storage resources are:
  1: File
Item 1 selected automatically.
Enter new Volume name:
```

at which point, you should enter some name beginning with a letter and containing only letters and numbers (period, hyphen, and underscore) are also permitted. For example, enter **TestVolume001**, and you should get back:

```
Defined Pools:
  1: Default
Item 1 selected automatically.
Connecting to Storage daemon File at rufus:8103 ...
Sending label command for Volume "TestVolume001" Slot 0 ...
3000 OK label. Volume=TestVolume001 Device=/tmp
Catalog record for Volume "TestVolume002", Slot 0  successfully created.
Requesting mount FileStorage ...
3001 OK mount. Device=/tmp
```

Finally, enter **messages** and you should get something like:

```
28-Apr-2003 14:30 rufus-sd: Wrote label to prelabeled Volume
      "TestVolume001" on device /tmp
28-Apr-2003 14:30 rufus-dir: Bacula 1.30 (28Apr03): 28-Apr-2003 14:30
JobId:                1
Job:                  Client1.2003-04-28_14.22.33
FileSet:              Full Set
Backup Level:         Full
Client:               rufus-fd
Start time:           28-Apr-2003 14:22
End time:             28-Apr-2003 14:30
Files Written:        1,444
Bytes Written:        38,988,877
Rate:                 81.2 KB/s
Software Compression: None
Volume names(s):      TestVolume001
Volume Session Id:    1
Volume Session Time:  1051531381
Last Volume Bytes:    39,072,359
FD termination status: OK
SD termination status: OK
Termination:          Backup OK
28-Apr-2003 14:30 rufus-dir: Begin pruning Jobs.
28-Apr-2003 14:30 rufus-dir: No Jobs found to prune.
28-Apr-2003 14:30 rufus-dir: Begin pruning Files.
28-Apr-2003 14:30 rufus-dir: No Files found to prune.
28-Apr-2003 14:30 rufus-dir: End auto prune.
```

If you don't see the output immediately, you can keep entering **messages** until the job terminates, or you can enter, **autodisplay on** and your messages will automatically be displayed as soon as they are ready. If you do an **ls -l** of your **/tmp** directory, you will see that you have the following item:

```
-rw-r-----  1 kern      kern      39072153 Apr 28 14:30 TestVolume001
```

This is the file Volume that you just wrote and it contains all the data of the job just run. If you run additional jobs, they will be appended to this Volume unless you specify otherwise.

You might ask yourself if you have to label all the Volumes that Bacula is going to use. The answer for disk Volumes, like the one we used, is no. It is possible to have Bacula automatically label volumes. For tape Volumes, you will most likely have to label each of the Volumes you want to use.

If you would like to stop here, you can simply enter **quit** in the Console program, and you can stop Bacula with **./bacula stop**. To clean up, simply delete the file **/tmp/TestVolume001**, and you should also re-initialize your database using:

```
./drop_bacula_tables
./make_bacula_tables
```

Please note that this will erase all information about the previous jobs that have run, and that you might want to do it now while testing but that normally you will not want to re-initialize your database.

If you would like to try restoring the files that you just backed up, read the following section.



12.6 Restoring Your Files

If you have run the default configuration and the save of the Bacula source code as demonstrated above, you can restore the backed up files in the Console program by entering:

```
restore all
```

where you will get:

First you select one or more JobIds that contain files to be restored. You will be presented several methods of specifying the JobIds. Then you will be allowed to select which files from those JobIds are to be restored.

```
To select the JobIds, you have the following choices:
  1: List last 20 Jobs run
  2: List Jobs where a given File is saved
  3: Enter list of comma separated JobIds to select
  4: Enter SQL list command
  5: Select the most recent backup for a client
  6: Select backup for a client before a specified time
  7: Enter a list of files to restore
  8: Enter a list of files to restore before a specified time
  9: Find the JobIds of the most recent backup for a client
 10: Find the JobIds for a backup for a client before a specified time
 11: Enter a list of directories to restore for found JobIds
 12: Cancel
Select item: (1-12):
```

As you can see, there are a number of options, but for the current demonstration, please enter **5** to do a restore of the last backup you did, and you will get the following output:

```
Defined Clients:
  1: rufus-fd
Item 1 selected automatically.
The defined FileSet resources are:
  1: 1 Full Set 2003-04-28 14:22:33
Item 1 selected automatically.
+-----+-----+-----+-----+-----+
| JobId | Level | JobFiles | StartTime          | VolumeName |
+-----+-----+-----+-----+-----+
| 1     | F    | 1444    | 2003-04-28 14:22:33 | TestVolume002 |
+-----+-----+-----+-----+-----+
You have selected the following JobId: 1
Building directory tree for JobId 1 ...
1 Job inserted into the tree and marked for extraction.
The defined Storage resources are:
  1: File
Item 1 selected automatically.
You are now entering file selection mode where you add and
remove files to be restored. All files are initially added.
Enter "done" to leave this mode.
cwd is: /
$
```

where I have truncated the listing on the right side to make it more readable. As you can see by starting at the top of the listing, Bacula knows what client you have, and since there was only one, it selected it automatically, likewise for the FileSet. Then Bacula produced a listing containing all the jobs that form the current backup, in this case, there is only one, and the Storage daemon was also automatically chosen. Bacula then took all the files that were in Job number 1 and entered them into a **directory tree** (a sort of in memory representation of your filesystem). At this point, you can use the **cd** and **ls** or **dir** commands to walk up and down the directory tree and view what files will be restored. For example, if I enter **cd /home/kern/bacula/bacula-1.30** and then enter **dir** I will get a listing of all the files in the Bacula source directory. On your system, the path will be somewhat different. For more information on this, please refer to the Restore Command Chapter of this manual for more details.

To exit this mode, simply enter:

```
done
```

and you will get the following output:



```
Bootstrap records written to
/home/kern/bacula/testbin/working/restore.bsr
The restore job will require the following Volumes:
```

```
TestVolume001
1444 files selected to restore.
Run Restore job
JobName:      RestoreFiles
Bootstrap:    /home/kern/bacula/testbin/working/restore.bsr
Where:        /tmp/bacula-restores
Replace:      always
FileSet:      Full Set
Backup Client: rufus-fd
Restore Client: rufus-fd
Storage:      File
JobId:        *None*
When:         2005-04-28 14:53:54
OK to run? (yes/mod/no):
```

If you answer **yes** your files will be restored to **/tmp/bacula-restores**. If you want to restore the files to their original locations, you must use the **mod** option and explicitly set **Where:** to nothing (or to **/**). We recommend you go ahead and answer **yes** and after a brief moment, enter **messages**, at which point you should get a listing of all the files that were restored as well as a summary of the job that looks similar to this:

```
28-Apr-2005 14:56 rufus-dir: Bacula 2.1.8 (08May07): 08-May-2007 14:56:06
Build OS:          i686-pc-linux-gnu suse 10.2
JobId:             2
Job:               RestoreFiles.2007-05-08_14.56.06
Restore Client:    rufus-fd
Start time:        08-May-2007 14:56
End time:          08-May-2007 14:56
Files Restored:    1,444
Bytes Restored:    38,816,381
Rate:              9704.1 KB/s
FD Errors:         0
FD termination status: OK
SD termination status: OK
Termination:      Restore OK
08-May-2007 14:56 rufus-dir: Begin pruning Jobs.
08-May-2007 14:56 rufus-dir: No Jobs found to prune.
08-May-2007 14:56 rufus-dir: Begin pruning Files.
08-May-2007 14:56 rufus-dir: No Files found to prune.
08-May-2007 14:56 rufus-dir: End auto prune.
```

After exiting the Console program, you can examine the files in **/tmp/bacula-restores**, which will contain a small directory tree with all the files. Be sure to clean up at the end with:

```
rm -rf /tmp/bacula-restore
```

12.7 Quitting the Console Program

Simply enter the command **quit**.

12.8 Adding a Second Client

If you have gotten the example shown above to work on your system, you may be ready to add a second Client (File daemon). That is you have a second machine that you would like backed up. The only part you need installed on the other machine is the binary **bacula-fd** (or **bacula-fd.exe** for Windows) and its configuration file **bacula-fd.conf**. You can start with the same **bacula-fd.conf** file that you are currently using and make one minor modification to it to create the conf file for your second client. Change the File daemon name from whatever was configured, **rufus-fd** in the example above, but your system will have a different name. The best is to change it to the name of your second machine. For example:

```
...
#
# "Global" File daemon configuration specifications
#
FileDaemon {
                                # this is me
```

```

Name = rufus-fd
FDport = 9102                # where we listen for the director
WorkingDirectory = /home/kern/bacula/working
Pid Directory = /var/run
}
...

```

would become:

```

...
#
# "Global" File daemon configuration specifications
#
FileDaemon {
    Name = matou-fd
    FDport = 9102                # where we listen for the director
    WorkingDirectory = /home/kern/bacula/working
    Pid Directory = /var/run
}
...

```

where I show just a portion of the file and have changed **rufus-fd** to **matou-fd**. The names you use are your choice. For the moment, I recommend you change nothing else. Later, you will want to change the password.

Now you should install that change on your second machine. Then you need to make some additions to your Director's configuration file to define the new File daemon or Client. Starting from our original example which should be installed on your system, you should add the following lines (essentially copies of the existing data but with the names changed) to your Director's configuration file **bacula-dir.conf**.

```

#
# Define the main nightly save backup job
# By default, this job will back up to disk in /tmp
Job {
    Name = "Matou"
    Type = Backup
    Client = matou-fd
    FileSet = "Full Set"
    Schedule = "WeeklyCycle"
    Storage = File
    Messages = Standard
    Pool = Default
    Write Bootstrap = "/home/kern/bacula/working/matou.bsr"
}
# Client (File Services) to backup
Client {
    Name = matou-fd
    Address = matou
    FDPort = 9102
    Catalog = MyCatalog
    Password = "xxxxx"           # password for
    File Retention = 30d         # 30 days
    Job Retention = 180d        # six months
    AutoPrune = yes             # Prune expired Jobs/Files
}

```

Then make sure that the Address parameter in the Storage resource is set to the fully qualified domain name and not to something like "localhost". The address specified is sent to the File daemon (client) and it must be a fully qualified domain name. If you pass something like "localhost" it will not resolve correctly and will result in a time out when the File daemon fails to connect to the Storage daemon.

That is all that is necessary. I copied the existing resource to create a second Job (Matou) to backup the second client (matou-fd). It has the name **Matou**, the Client is named **matou-fd**, and the bootstrap file name is changed, but everything else is the same. This means that Matou will be backed up on the same schedule using the same set of tapes. You may want to change that later, but for now, let's keep it simple. The second change was to add a new Client resource that defines **matou-fd** and has the correct address **matou**, but in real life, you may need a fully qualified domain name or an IP address. I also kept the password the same (shown as xxxxx for the example).

At this point, if you stop Bacula and restart it, and start the Client on the other machine, everything will be ready, and the prompts that you saw above will now include the second machine.

To make this a real production installation, you will possibly want to use different Pool, or a different schedule. It is up to you to customize. In any case, you should change the password in both the Director's file and the Client's file for additional security.



For some important tips on changing names and passwords, and a diagram of what names and passwords must match, please see **Authorization Errors** chapter (chapter 1.5 on page 6) in the Bacula Community Problem Resolution Guide.

12.9 When The Tape Fills

If you have scheduled your job, typically nightly, there will come a time when the tape fills up and **Bacula** cannot continue. In this case, Bacula will send you a message similar to the following:

```
rufus-sd: block.c:337 === Write error errno=28: ERR=No space left
on device
```

This indicates that Bacula got a write error because the tape is full. Bacula will then search the Pool specified for your Job looking for an appendable volume. In the best of all cases, you will have properly set your Retention Periods and you will have all your tapes marked to be Recycled, and **Bacula** will automatically recycle the tapes in your pool requesting and overwriting old Volumes. For more information on recycling, please see the Recycling chapter of this manual. If you find that your Volumes were not properly recycled (usually because of a configuration error), please see the Manually Recycling Volumes section of the Recycling chapter.

If like me, you have a very large set of Volumes and you label them with the date the Volume was first writing, or you have not set up your Retention periods, Bacula will not find a tape in the pool, and it will send you a message similar to the following:

```
rufus-sd: Job kernsave.2002-09-19.10:50:48 waiting. Cannot find any
appendable volumes.
Please use the "label" command to create a new Volume for:
Storage:      STD-10000
Media type:   DDS-4
Pool:         Default
```

Until you create a new Volume, this message will be repeated an hour later, then two hours later, and so on doubling the interval each time up to a maximum interval of one day.

The obvious question at this point is: What do I do now?

The answer is simple: first, using the Console program, close the tape drive using the **unmount** command. If you only have a single drive, it will be automatically selected, otherwise, make sure you release the one specified on the message (in this case **STD-10000**).

Next, you remove the tape from the drive and insert a new blank tape. Note, on some older tape drives, you may need to write an end of file mark (**mt -f /dev/nst0 weof**) to prevent the drive from running away when Bacula attempts to read the label.

Finally, you use the **label** command in the Console to write a label to the new Volume. The **label** command will contact the Storage daemon to write the software label, if it is successful, it will add the new Volume to the Pool, then issue a **mount** command to the Storage daemon. See the previous sections of this chapter for more details on labeling tapes.

The result is that Bacula will continue the previous Job writing the backup to the new Volume.

If you have a Pool of volumes and Bacula is cycling through them, instead of the above message "Cannot find any appendable volumes.", Bacula may ask you to mount a specific volume. In that case, you should attempt to do just that. If you do not have the volume any more (for any of a number of reasons), you can simply mount another volume from the same Pool, providing it is appendable, and Bacula will use it. You can use the **list volumes** command in the console program to determine which volumes are appendable and which are not.

If like me, you have your Volume retention periods set correctly, but you have no more free Volumes, you can relabel and reuse a Volume as follows:

- Do a **list volumes** in the Console and select the oldest Volume for relabeling.
- If you have setup your Retention periods correctly, the Volume should have VolStatus **Purged**.
- If the VolStatus is not set to Purged, you will need to purge the database of Jobs that are written on that Volume. Do so by using the command **purge jobs volume** in the Console. If you have multiple Pools, you will be prompted for the Pool then enter the VolumeName (or MediaId) when requested.
- Then simply use the **relabel** command to relabel the Volume.

To manually relabel the Volume use the following additional steps:



- To delete the Volume from the catalog use the **delete volume** command in the Console and select the VolumeName (or MediaId) to be deleted.
- Use the **unmount** command in the Console to unmount the old tape.
- Physically relabel the old Volume that you deleted so that it can be reused.
- Insert the old Volume in the tape drive.
- From a command line do: **mt -f /dev/st0 rewind** and **mt -f /dev/st0 weof**, where you need to use the proper tape drive name for your system in place of **/dev/st0**.
- Use the **label** command in the Console to write a new Bacula label on your tape.
- Use the **mount** command in the Console if it is not automatically done, so that Bacula starts using your newly labeled tape.

12.10 Other Useful Console Commands

status dir Print a status of all running jobs and jobs scheduled in the next 24 hours.

status The console program will prompt you to select a daemon type, then will request the daemon's status.

status jobid=nn Print a status of JobId nn if it is running. The Storage daemon is contacted and requested to print a current status of the job as well.

list pools List the pools defined in the Catalog (normally only Default is used).

list media Lists all the media defined in the Catalog.

list jobs Lists all jobs in the Catalog that have run.

list jobid=nn Lists JobId nn from the Catalog.

list jobtotals Lists totals for all jobs in the Catalog.

list files jobid=nn List the files that were saved for JobId nn.

list jobmedia List the media information for each Job run.

messages Prints any messages that have been directed to the console.

unmount storage=storage-name Unmounts the drive associated with the storage device with the name **storage-name** if the drive is not currently being used. This command is used if you wish Bacula to free the drive so that you can use it to label a tape.

mount storage=storage-name Causes the drive associated with the storage device to be mounted again. When Bacula reaches the end of a volume and requests you to mount a new volume, you must issue this command after you have placed the new volume in the drive. In effect, it is the signal needed by Bacula to know to start reading or writing the new volume.

quit Exit or quit the console program.

Most of the commands given above, with the exception of **list**, will prompt you for the necessary arguments if you simply enter the command name.

12.11 Debug Daemon Output

If you want debug output from the daemons as they are running, start the daemons from the install directory as follows:

```
./bacula start -d100
```

This can be particularly helpful if your daemons do not start correctly, because direct daemon output to the console is normally directed to the NULL device, but with the debug level greater than zero, the output will be sent to the starting terminal.

To stop the three daemons, enter the following from the install directory:



```
./bacula stop
```

The execution of **bacula stop** may complain about pids not found. This is OK, especially if one of the daemons has died, which is very rare.

To do a full system save, each File daemon must be running as root so that it will have permission to access all the files. None of the other daemons require root privileges. However, the Storage daemon must be able to open the tape drives. On many systems, only root can access the tape drives. Either run the Storage daemon as root, or change the permissions on the tape devices to permit non-root access. MySQL and PostgreSQL can be installed and run with any userid; root privilege is not necessary.

12.12 Patience When Starting Daemons or Mounting Blank Tapes

When you start the Bacula daemons, the Storage daemon attempts to open all defined storage devices and verify the currently mounted Volume (if configured). Until all the storage devices are verified, the Storage daemon will not accept connections from the Console program. If a tape was previously used, it will be rewound, and on some devices this can take several minutes. As a consequence, you may need to have a bit of patience when first contacting the Storage daemon after starting the daemons. If you can see your tape drive, once the lights stop flashing, the drive will be ready to be used.

The same considerations apply if you have just mounted a blank tape in a drive such as an HP DLT. It can take a minute or two before the drive properly recognizes that the tape is blank. If you attempt to **mount** the tape with the Console program during this recognition period, it is quite possible that you will hang your SCSI driver (at least on my Red Hat Linux system). As a consequence, you are again urged to have patience when inserting blank tapes. Let the device settle down before attempting to access it.

12.13 Difficulties Connecting from the FD to the SD

If you are having difficulties getting one or more of your File daemons to connect to the Storage daemon, it is most likely because you have not used a fully qualified domain name on the **Address** directive in the Director's Storage resource. That is the resolver on the File daemon's machine (not on the Director's) must be able to resolve the name you supply into an IP address. An example of an address that is guaranteed not to work: **localhost**. An example that may work: **megalon**. An example that is more likely to work: **magalon.mydomain.com**. On Win32 if you don't have a good resolver (often true on older Win98 systems), you might try using an IP address in place of a name.

If your address is correct, then make sure that no other program is using the port 9103 on the Storage daemon's machine. The Bacula port numbers are authorized by IANA, and should not be used by other programs, but apparently some HP printers do use these port numbers. A **netstat -a** on the Storage daemon's machine can determine who is using the 9103 port (used for FD to SD communications in Bacula).

12.14 Daemon Command Line Options

Each of the three daemons (Director, File, Storage) accepts a small set of options on the command line. In general, each of the daemons as well as the Console program accepts the following options:

- c <file>** Define the file to use as a configuration file. The default is the daemon name followed by **.conf** i.e. **bacula-dir.conf** for the Director, **bacula-fd.conf** for the File daemon, and **bacula-sd** for the Storage daemon.
- d nn** Set the debug level to **nn**. Higher levels of debug cause more information to be displayed on STDOUT concerning what the daemon is doing.
- f** Run the daemon in the foreground. This option is needed to run the daemon under the debugger.
- g ;group;** Run the daemon under this group. This must be a group name, not a GID.
- s** Do not trap signals. This option is needed to run the daemon under the debugger.
- t** Read the configuration file and print any error messages, then immediately exit. Useful for syntax testing of new configuration files.
- u ;user;** Run the daemon as this user. This must be a user name, not a UID.



-v Be more verbose or more complete in printing error and informational messages. Recommended.

-? Print the version and list of options.

12.15 Creating a Pool

Creating the Pool is automatically done when **Bacula** starts, so if you understand Pools, you can skip to the next section.

When you run a job, one of the things that Bacula must know is what Volumes to use to backup the FileSet. Instead of specifying a Volume (tape) directly, you specify which Pool of Volumes you want Bacula to consult when it wants a tape for writing backups. Bacula will select the first available Volume from the Pool that is appropriate for the Storage device you have specified for the Job being run. When a volume has filled up with data, **Bacula** will change its VolStatus from **Append** to **Full**, and then **Bacula** will use the next volume and so on. If no appendable Volume exists in the Pool, the Director will attempt to recycle an old Volume, if there are still no appendable Volumes available, **Bacula** will send a message requesting the operator to create an appropriate Volume.

Bacula keeps track of the Pool name, the volumes contained in the Pool, and a number of attributes of each of those Volumes.

When Bacula starts, it ensures that all Pool resource definitions have been recorded in the catalog. You can verify this by entering:

```
list pools
```

to the console program, which should print something like the following:

```
*list pools
Using default Catalog name=MySQL DB=bacula
+-----+-----+-----+-----+-----+-----+
| PoolId | Name   | NumVols | MaxVols | PoolType | LabelFormat |
+-----+-----+-----+-----+-----+-----+
| 1      | Default | 3       | 0       | Backup   | *           |
| 2      | File   | 12      | 12      | Backup   | File        |
+-----+-----+-----+-----+-----+-----+
*
```

If you attempt to create the same Pool name a second time, **Bacula** will print:

```
Error: Pool Default already exists.
Once created, you may use the {\bf update} command to
modify many of the values in the Pool record.
```

12.16 Labeling Your Volumes

Bacula requires that each Volume contains a software label. There are several strategies for labeling volumes. The one I use is to label them as they are needed by **Bacula** using the console program. That is when Bacula needs a new Volume, and it does not find one in the catalog, it will send me an email message requesting that I add Volumes to the Pool. I then use the **label** command in the Console program to label a new Volume and to define it in the Pool database, after which Bacula will begin writing on the new Volume. Alternatively, I can use the Console **relabel** command to relabel a Volume that is no longer used providing it has VolStatus **Purged**.

Another strategy is to label a set of volumes at the start, then use them as **Bacula** requests them. This is most often done if you are cycling through a set of tapes, for example using an autochanger. For more details on recycling, please see the Automatic Volume Recycling chapter of this manual.

If you run a Bacula job, and you have no labeled tapes in the Pool, Bacula will inform you, and you can create them "on-the-fly" so to speak. In my case, I label my tapes with the date, for example: **DLT-18April02**. See below for the details of using the **label** command.

12.17 Labeling Volumes with the Console Program

Labeling volumes is normally done by using the console program.

1. ./bconsole



2. label

If Bacula complains that you cannot label the tape because it is already labeled, simply **unmount** the tape using the **unmount** command in the console, then physically mount a blank tape and re-issue the **label** command.

Since the physical storage media is different for each device, the **label** command will provide you with a list of the defined Storage resources such as the following:

```
The defined Storage resources are:
  1: File
  2: 8mmDrive
  3: DLTDrive
  4: SDT-10000
Select Storage resource (1-4):
```

At this point, you should have a blank tape in the drive corresponding to the Storage resource that you select.

It will then ask you for the Volume name.

```
Enter new Volume name:
```

If Bacula complains:

```
Media record for Volume xxxx already exists.
```

It means that the volume name **xxxx** that you entered already exists in the Media database. You can list all the defined Media (Volumes) with the **list media** command. Note, the LastWritten column has been truncated for proper printing.

```
+-----+-----+-----+-----+-----+-----+-----+
| VolumeName | MediaTyp| VolStat| VolBytes      | LastWri | VolReten | Recy|
+-----+-----+-----+-----+-----+-----+-----+
| DLTVol10002 | DLT8000 | Purged | 56,128,042,217 | 2001-10 | 31,536,000 | 0 |
| DLT-07Oct2001 | DLT8000 | Full   | 56,172,030,586 | 2001-11 | 31,536,000 | 0 |
| DLT-08Nov2001 | DLT8000 | Full   | 55,691,684,216 | 2001-12 | 31,536,000 | 0 |
| DLT-01Dec2001 | DLT8000 | Full   | 55,162,215,866 | 2001-12 | 31,536,000 | 0 |
| DLT-28Dec2001 | DLT8000 | Full   | 57,888,007,042 | 2002-01 | 31,536,000 | 0 |
| DLT-20Jan2002 | DLT8000 | Full   | 57,003,507,308 | 2002-02 | 31,536,000 | 0 |
| DLT-16Feb2002 | DLT8000 | Full   | 55,772,630,824 | 2002-03 | 31,536,000 | 0 |
| DLT-12Mar2002 | DLT8000 | Full   | 50,666,320,453 | 1970-01 | 31,536,000 | 0 |
| DLT-27Mar2002 | DLT8000 | Full   | 57,592,952,309 | 2002-04 | 31,536,000 | 0 |
| DLT-15Apr2002 | DLT8000 | Full   | 57,190,864,185 | 2002-05 | 31,536,000 | 0 |
| DLT-04May2002 | DLT8000 | Full   | 60,486,677,724 | 2002-05 | 31,536,000 | 0 |
| DLT-26May02   | DLT8000 | Append | 1,336,699,620 | 2002-05 | 31,536,000 | 1 |
+-----+-----+-----+-----+-----+-----+-----+
```

Once Bacula has verified that the volume does not already exist, it will prompt you for the name of the Pool in which the Volume (tape) is to be created. If there is only one Pool (Default), it will be automatically selected.

If the tape is successfully labeled, a Volume record will also be created in the Pool. That is the Volume name and all its other attributes will appear when you list the Pool. In addition, that Volume will be available for backup if the MediaType matches what is requested by the Storage daemon.

When you labeled the tape, you answered very few questions about it – principally the Volume name, and perhaps the Slot. However, a Volume record in the catalog database (internally known as a Media record) contains quite a few attributes. Most of these attributes will be filled in from the default values that were defined in the Pool (i.e. the Pool holds most of the default attributes used when creating a Volume).

It is also possible to add media to the pool without physically labeling the Volumes. This can be done with the **add** command. For more information, please see the **Console** chapter (chapter 1 on page 1) of the Bacula Community Console Manual.



Chapter 13

Customizing the Configuration Files

When each of the Bacula programs starts, it reads a configuration file specified on the command line or the default `bacula-dir.conf`, `bacula-fd.conf`, `bacula-sd.conf`, or `console.conf` for the Director daemon, the File daemon, the Storage daemon, and the Console program respectively.

Each service (Director, Client, Storage, Console) has its own configuration file containing a set of Resource definitions. These resources are very similar from one service to another, but may contain different directives (records) depending on the service. For example, in the Director's resource file, the **Director** resource defines the name of the Director, a number of global Director parameters and his password. In the File daemon configuration file, the **Director** resource specifies which Directors are permitted to use the File daemon.

Before running Bacula for the first time, you must customize the configuration files for each daemon. Default configuration files will have been created by the installation process, but you will need to modify them to correspond to your system. An overall view of the resources can be seen in the following:

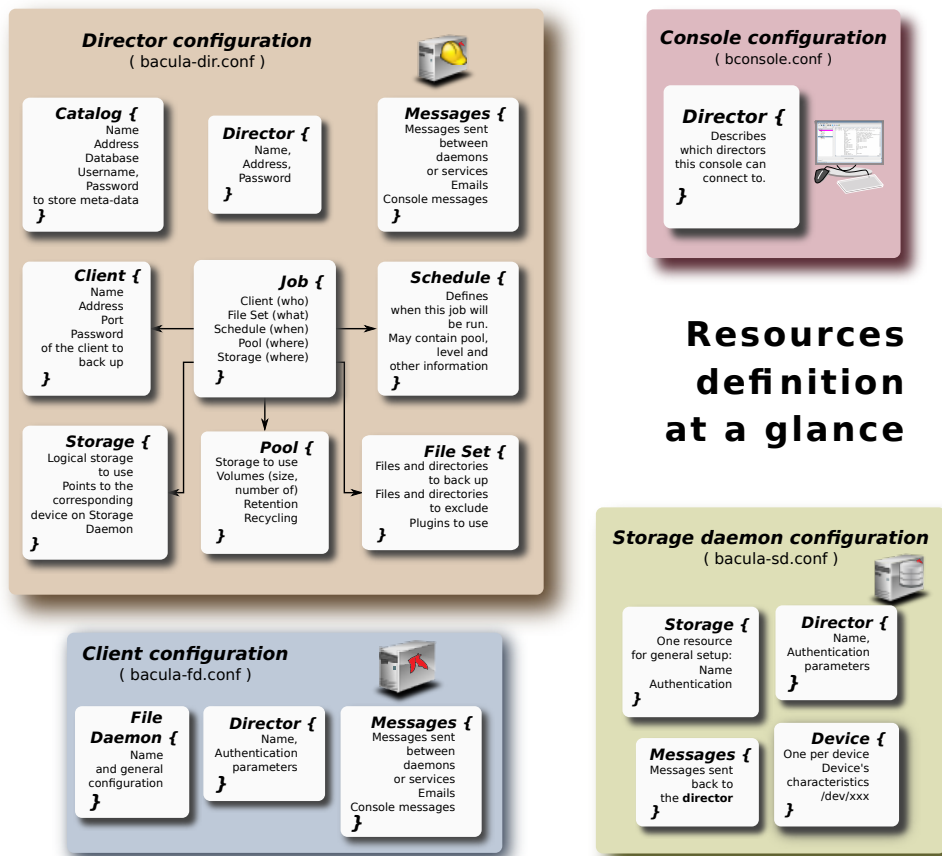



13.1 Character Sets

Bacula is designed to handle most character sets of the world, US ASCII, German, French, Chinese, ... However, it does this by encoding everything in UTF-8, and it expects all configuration files (including those read on Win32 machines) to be in UTF-8 format. UTF-8 is typically the default on Linux machines, but not on all Unix machines, nor on Windows, so you must take some care to ensure that your locale is set properly before starting Bacula.

To ensure that Bacula configuration files can be correctly read including foreign characters the `bf LANG` environment variable must end in **.UTF-8**. An full example is **en_US.UTF-8**. The exact syntax may vary a bit from OS to OS, and exactly how you define it will also vary. On most newer Win32 machines, you can use **notepad** to edit the conf files, then choose output encoding UTF-8.

Bacula assumes that all filenames are in UTF-8 format on Linux and Unix machines. On Win32 they are in Unicode (UTF-16), and will be automatically converted to UTF-8 format.

13.2 Resource Directive Format

Although, you won't need to know the details of all the directives a basic knowledge of Bacula resource directives is essential. Each directive contained within the resource (within the braces) is composed of a keyword followed by an equal sign (=) followed by one or more values. The keywords must be one of the known Bacula resource record keywords, and it may be composed of upper or lower case characters and spaces.

Each resource definition **MUST** contain a Name directive, and may optionally contain a Description directive. The Name directive is used to uniquely identify the resource. The Description directive is (will be) used during display of the Resource to provide easier human recognition. For example:

```
Director {
  Name = "MyDir"
  Description = "Main Bacula Director"
  WorkingDirectory = "$HOME/bacula/bin/working"
}
```

Defines the Director resource with the name "MyDir" and a working directory \$HOME/bacula/bin/working. In general, if you want spaces in a name to the right of the first equal sign (=), you must enclose that name within double quotes. Otherwise quotes are not generally necessary because once defined, quoted strings and unquoted strings are all equal.

13.2.1 Comments

When reading the configuration file, blank lines are ignored and everything after a hash sign (#) until the end of the line is taken to be a comment. A semicolon (;) is a logical end of line, and anything after the semicolon is considered as the next statement. If a statement appears on a line by itself, a semicolon is not necessary to terminate it, so generally in the examples in this manual, you will not see many semicolons.

13.2.2 Upper and Lower Case and Spaces

Case (upper/lower) and spaces are totally ignored in the resource directive keywords (the part before the equal sign).

Within the keyword (i.e. before the equal sign), spaces are not significant. Thus the keywords: **name**, **Name**, and **N a m e** are all identical.

Spaces after the equal sign and before the first character of the value are ignored.

In general, spaces within a value are significant (not ignored), and if the value is a name, you must enclose the name in double quotes for the spaces to be accepted. Names may contain up to 127 characters. Currently, a name may contain any ASCII character. Within a quoted string, any character following a backslash (\) is taken as itself (handy for inserting backslashes and double quotes (")).

Please note, however, that Bacula resource names as well as certain other names (e.g. Volume names) must contain only letters (including ISO accented letters), numbers, and a few special characters (space, underscore, ...). All other characters and punctuation are invalid.



13.2.3 Including other Configuration Files

If you wish to break your configuration file into smaller pieces, you can do so by including other files using the syntax `@filename` where **filename** is the full path and filename of another file. The `@filename` specification can be given anywhere a primitive token would appear.

If you wish include all files in a specific directory, you can use the following:

```
# Include subfiles associated with configuration of clients.
# They define the bulk of the Clients, Jobs, and FileSets.
# Remember to "reload" the Director after adding a client file.
#
@|"sh -c 'for f in /etc/bacula/clientdefs/*.conf ; do echo @{$f} ; done'"
```

13.2.4 Recognized Primitive Data Types

When parsing the resource directives, Bacula classifies the data according to the types listed below. The first time you read this, it may appear a bit overwhelming, but in reality, it is all pretty logical and straightforward.

name A keyword or name consisting of alphanumeric characters, including the hyphen, underscore, and dollar characters. The first character of a **name** must be a letter. A name has a maximum length currently set to 127 bytes. Typically keywords appear on the left side of an equal (i.e. they are Bacula keywords – i.e. Resource names or directive names). Keywords may not be quoted.

name-string A name-string is similar to a name, except that the name may be quoted and can thus contain additional characters including spaces. Name strings are limited to 127 characters in length. Name strings are typically used on the right side of an equal (i.e. they are values to be associated with a keyword).

string A quoted string containing virtually any character including spaces, or a non-quoted string. A string may be of any length. Strings are typically values that correspond to filenames, directories, or system command names. A backslash (`\`) turns the next character into itself, so to include a double quote in a string, you precede the double quote with a backslash. Likewise to include a backslash.

directory A directory is either a quoted or non-quoted string. A directory will be passed to your standard shell for expansion when it is scanned. Thus constructs such as **\$HOME** are interpreted to be their correct values.

password This is a Bacula password and it is stored internally in MD5 hashed format.

integer A 32 bit integer value. It may be positive or negative.

positive integer A 32 bit positive integer value.

long integer A 64 bit integer value. Typically these are values such as bytes that can exceed 4 billion and thus require a 64 bit value.

yes|no Either a **yes** or a **no**.

size A size specified as bytes. Typically, this is a floating point scientific input format followed by an optional modifier. The floating point input is stored as a 64 bit integer value. If a modifier is present, it must immediately follow the value with no intervening spaces. The following modifiers are permitted:

k 1,024 (kilobytes)

kb 1,000 (kilobytes)

m 1,048,576 (megabytes)

mb 1,000,000 (megabytes)

g 1,073,741,824 (gigabytes)

gb 1,000,000,000 (gigabytes)

time A time or duration specified in seconds. The time is stored internally as a 64 bit integer value, but it is specified in two parts: a number part and a modifier part. The number can be an integer or a floating point number. If it is entered in floating point notation, it will be rounded to the nearest integer. The modifier is mandatory and follows the number part, either with or without intervening spaces. The following modifiers are permitted:



seconds seconds
minutes minutes (60 seconds)
hours hours (3600 seconds)
days days (3600*24 seconds)
weeks weeks (3600*24*7 seconds)
months months (3600*24*30 seconds)
quarters quarters (3600*24*91 seconds)
years years (3600*24*365 seconds)

Any abbreviation of these modifiers is also permitted (i.e. **seconds** may be specified as **sec** or **s**). A specification of **m** will be taken as months.

The specification of a time may have as many number/modifier parts as you wish. For example:

```
1 week 2 days 3 hours 10 mins
1 month 2 days 30 sec
```

are valid date specifications.

13.3 Resource Types

The following table lists all current Bacula resource types. It shows what resources must be defined for each service (daemon). The default configuration files will already contain at least one example of each permitted resource, so you need not worry about creating all these kinds of resources from scratch.

Resource	Director	Client	Storage	Console
Autochanger	No	No	Yes	No
Catalog	Yes	No	No	No
Client	Yes	Yes	No	No
Console	Yes	No	No	Yes
Device	No	No	Yes	No
Director	Yes	Yes	Yes	Yes
FileSet	Yes	No	No	No
Job	Yes	No	No	No
JobDefs	Yes	No	No	No
Message	Yes	Yes	Yes	No
Pool	Yes	No	No	No
Schedule	Yes	No	No	No
Storage	Yes	No	Yes	No

13.4 Names, Passwords and Authorization

In order for one daemon to contact another daemon, it must authorize itself with a password. In most cases, the password corresponds to a particular name, so both the name and the password must match to be authorized. Passwords are plain text, any text. They are not generated by any special process; just use random text.

The default configuration files are automatically defined for correct authorization with random passwords. If you add to or modify these files, you will need to take care to keep them consistent.



Here is sort of a picture of what names/passwords in which files/Resources must match up:

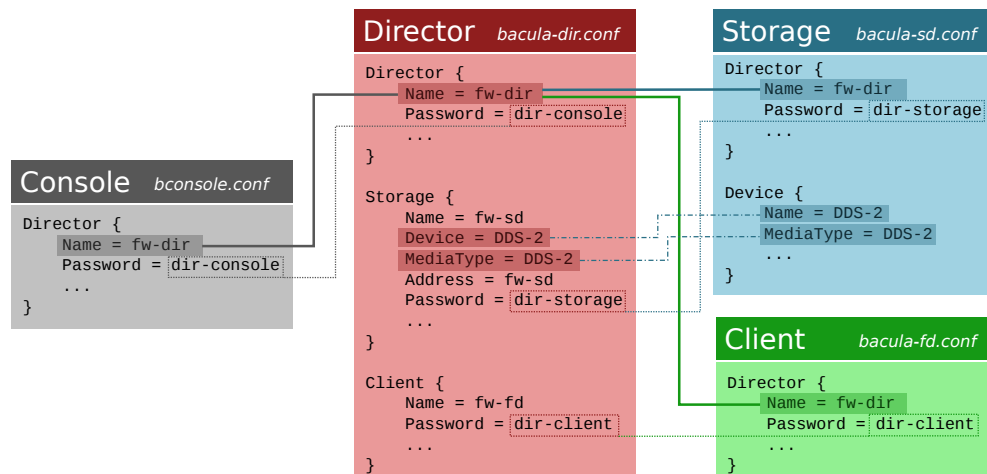

In the left column, you will find the Director, Storage, and Client resources, with their names and passwords – these are all in **bacula-dir.conf**. In the right column are where the corresponding values should be found in the Console, Storage daemon (SD), and File daemon (FD) configuration files.

Please note that the Address, **fd-sd**, that appears in the Storage resource of the Director, preceded with an asterisk in the above example, is passed to the File daemon in symbolic form. The File daemon then resolves it to an IP address. For this reason, you must use either an IP address or a fully qualified name. A name such as **localhost**, not being a fully qualified name, will resolve in the File daemon to the localhost of the File daemon, which is most likely not what is desired. The password used for the File daemon to authorize with the Storage daemon is a temporary password unique to each Job created by the daemons and is not specified in any .conf file.

13.5 Detailed Information for each Daemon

The details of each Resource and the directives permitted therein are described in the following chapters. The following configuration files must be defined:

- Console – to define the resources for the Console program (user interface to the Director). It defines which Directors are available so that you may interact with them.
- Director – to define the resources necessary for the Director. You define all the Clients and Storage daemons that you use in this configuration file.
- Client – to define the resources for each client to be backed up. That is, you will have a separate Client resource file on each machine that runs a File daemon.
- Storage – to define the resources to be used by each Storage daemon. Normally, you will have a single Storage daemon that controls your tape drive or tape drives. However, if you have tape drives on several machines, you will have at least one Storage daemon per machine.





Chapter 14

Configuring the Director

Of all the configuration files needed to run **Bacula**, the Director's is the most complicated, and the one that you will need to modify the most often as you add clients or modify the FileSets.

For a general discussion of configuration files and resources including the data types recognized by **Bacula**. Please see the Configuration chapter of this manual.

14.1 Director Resource Types

Director resource type may be one of the following:

Job, JobDefs, Client, Storage, Catalog, Schedule, FileSet, Pool, Director, or Messages. We present them here in the most logical order for defining them:

Note, everything revolves around a job and is tied to a job in one way or another.

- Director – to define the Director's name and its access password used for authenticating the Console program. Only a single Director resource definition may appear in the Director's configuration file. If you have either `/dev/random` or `bc` on your machine, Bacula will generate a random password during the configuration process, otherwise it will be left blank.
- Job – to define the backup/restore Jobs and to tie together the Client, FileSet and Schedule resources to be used for each Job. Normally, you will Jobs of different names corresponding to each client (i.e. one Job per client, but a different one with a different name for each client).
- JobDefs – optional resource for providing defaults for Job resources.
- Schedule – to define when a Job is to be automatically run by **Bacula's** internal scheduler. You may have any number of Schedules, but each job will reference only one.
- FileSet – to define the set of files to be backed up for each Client. You may have any number of FileSets but each Job will reference only one.
- Client – to define what Client is to be backed up. You will generally have multiple Client definitions. Each Job will reference only a single client.
- Storage – to define on what physical device the Volumes should be mounted. You may have one or more Storage definitions.
- Pool – to define the pool of Volumes that can be used for a particular Job. Most people use a single default Pool. However, if you have a large number of clients or volumes, you may want to have multiple Pools. Pools allow you to restrict a Job (or a Client) to use only a particular set of Volumes.
- Catalog – to define in what database to keep the list of files and the Volume names where they are backed up. Most people only use a single catalog. However, if you want to scale the Director to many clients, multiple catalogs can be helpful. Multiple catalogs require a bit more management because in general you must know what catalog contains what data. Currently, all Pools are defined in each catalog. This restriction will be removed in a later release.
- Messages – to define where error and information messages are to be sent or logged. You may define multiple different message resources and hence direct particular classes of messages to different users or locations (files, ...).



14.2 The Director Resource

The Director resource defines the attributes of the Directors running on the network. In the current implementation, there is only a single Director resource, but the final design will contain multiple Directors to maintain index and media database redundancy.

Director Start of the Director resource. One and only one director resource must be supplied.

Name = `<name>` The director name used by the system administrator. This directive is required.

Description = `<text>` The text field contains a description of the Director that will be displayed in the graphical user interface. This directive is optional.

Password = `<UA-password>` Specifies the password that must be supplied for the default Bacula Console to be authorized. The same password must appear in the **Director** resource of the Console configuration file. For added security, the password is never passed across the network but instead a challenge response hash code created with the password. This directive is required. If you have either `/dev/random` or `bc` on your machine, Bacula will generate a random password during the configuration process, otherwise it will be left blank and you must manually supply it.

The password is plain text. It is not generated through any special process but as noted above, it is better to use random text for security reasons.

Messages = `<Messages-resource-name>` The messages resource specifies where to deliver Director messages that are not associated with a specific Job. Most messages are specific to a job and will be directed to the Messages resource specified by the job. However, there are a few messages that can occur when no job is running. This directive is required.

Working Directory = `<Directory>` This directive is mandatory and specifies a directory in which the Director may put its status files. This directory should be used only by Bacula but may be shared by other Bacula daemons. However, please note, if this directory is shared with other Bacula daemons (the File daemon and Storage daemon), you must ensure that the **Name** given to each daemon is unique so that the temporary filenames used do not collide. By default the Bacula configure process creates unique daemon names by postfixing them with `-dir`, `-fd`, and `-sd`. Standard shell expansion of the **Directory** is done when the configuration file is read so that values such as `$HOME` will be properly expanded. This directive is required. The working directory specified must already exist and be readable and writable by the Bacula daemon referencing it.

If you have specified a Director user and/or a Director group on your `./configure` line with `--with-dir-user` and/or `--with-dir-group` the Working Directory owner and group will be set to those values.

Pid Directory = `<Directory>` This directive is mandatory and specifies a directory in which the Director may put its process Id file. The process Id file is used to shutdown Bacula and to prevent multiple copies of Bacula from running simultaneously. Standard shell expansion of the **Directory** is done when the configuration file is read so that values such as `$HOME` will be properly expanded.

The PID directory specified must already exist and be readable and writable by the Bacula daemon referencing it

Typically on Linux systems, you will set this to: `/var/run`. If you are not installing Bacula in the system directories, you can use the **Working Directory** as defined above. This directive is required.

Scripts Directory = `<Directory>` This directive is optional and, if defined, specifies a directory in which the Director will look for the Python startup script `DirStartup.py`. This directory may be shared by other Bacula daemons. Standard shell expansion of the directory is done when the configuration file is read so that values such as `$HOME` will be properly expanded.

QueryFile = `<Path>` This directive is mandatory and specifies a directory and file in which the Director can find the canned SQL statements for the **Query** command of the Console. Standard shell expansion of the **Path** is done when the configuration file is read so that values such as `$HOME` will be properly expanded. This directive is required.

Heartbeat Interval = `<time-interval>` This directive is optional and if specified will cause the Director to set a keepalive interval (heartbeat) in seconds on each of the sockets it opens for the Client resource. This value will override any specified at the Director level. It is implemented only on systems (Linux, ...) that provide the `setsockopt` `TCP_KEEPIIDLE` function. The default value is zero, which means no change is made to the socket.



Maximum Concurrent Jobs = **<number>** where **<number>** is the maximum number of total Director Jobs that should run concurrently. The default is set to 1, but you may set it to a larger number.

The Volume format becomes more complicated with multiple simultaneous jobs, consequently, restores may take longer if Bacula must sort through interleaved volume blocks from multiple simultaneous jobs. This can be avoided by having each simultaneous job write to a different volume or by using data spooling, which will first spool the data to disk simultaneously, then write one spool file at a time to the volume thus avoiding excessive interleaving of the different job blocks.

FD Connect Timeout = **<time>** where **time** is the time that the Director should continue attempting to contact the File daemon to start a job, and after which the Director will cancel the job. The default is 30 minutes.

SD Connect Timeout = **<time>** where **time** is the time that the Director should continue attempting to contact the Storage daemon to start a job, and after which the Director will cancel the job. The default is 30 minutes.

DirAddresses = **<IP-address-specification>** Specify the ports and addresses on which the Director daemon will listen for Bacula Console connections. Probably the simplest way to explain this is to show an example:

```
DirAddresses = {
  ip = {addr = 1.2.3.4; port = 1205;}
  ipv4 = {
    addr = 1.2.3.4; port = http;}
  ipv6 = {
    addr = 1.2.3.4;
    port = 1205;
  }
  ip = {
    addr = 1.2.3.4
    port = 1205
  }
  ip = {addr = 1.2.3.4 }
  ip = {addr = 201:220:222::2 }
  ip = {
    addr = bluedot.thun.net
  }
}
```

where ip, ip4, ip6, addr, and port are all keywords. Note, that the address can be specified as either a dotted quadruple, or IPv6 colon notation, or as a symbolic name (only in the ip specification). Also, port can be specified as a number or as the mnemonic value from the /etc/services file. If a port is not specified, the default will be used. If an ip section is specified, the resolution can be made either by IPv4 or IPv6. If ip4 is specified, then only IPv4 resolutions will be permitted, and likewise with ip6.

Please note that if you use the DirAddresses directive, you must not use either a DirPort or a DirAddress directive in the same resource.

DirPort = **<port-number>** Specify the port (a positive integer) on which the Director daemon will listen for Bacula Console connections. This same port number must be specified in the Director resource of the Console configuration file. The default is 9101, so normally this directive need not be specified. This directive should not be used if you specify DirAddresses (N.B plural) directive.

DirAddress = **<IP-Address>** This directive is optional, but if it is specified, it will cause the Director server (for the Console program) to bind to the specified **IP-Address**, which is either a domain name or an IP address specified as a dotted quadruple in string or quoted string format. If this directive is not specified, the Director will bind to any available address (the default). Note, unlike the DirAddresses specification noted above, this directive only permits a single address to be specified. This directive should not be used if you specify a DirAddresses (N.B. plural) directive.

DirSourceAddress = **<IP-Address>** This record is optional, and if it is specified, it will cause the Director server (when initiating connections to a storage or file daemon) to source its connections from the specified address. Only a single IP address may be specified. If this record is not specified, the Director server will source its outgoing connections according to the system routing table (the default).



Statistics Retention = `<time>` The **Statistics Retention** directive defines the length of time that Bacula will keep statistics job records in the Catalog database after the Job End time. (In **JobHistory** table) When this time period expires, and if user runs **prune stats** command, Bacula will prune (remove) Job records that are older than the specified period.

These statistics records aren't use for restore purpose, but mainly for capacity planning, billings, etc. See Statistics chapter for additional information.

See the Configuration chapter of this manual for additional details of time specification.

The default is 5 years.

VerId = `<string>` where `<string>` is an identifier which can be used for support purpose. This string is displayed using the **version** command.

MaximumConsoleConnections = `<number>` where `<number>` is the maximum number of Console Connections that could run concurrently. The default is set to 20, but you may set it to a larger number.

The following is an example of a valid Director resource definition:

```
Director {
  Name = HeadMan
  WorkingDirectory = "$HOME/bacula/bin/working"
  Password = UA_password
  PidDirectory = "$HOME/bacula/bin/working"
  QueryFile = "$HOME/bacula/bin/query.sql"
  Messages = Standard
}
```

14.3 The Job Resource

The Job resource defines a Job (Backup, Restore, ...) that Bacula must perform. Each Job resource definition contains the name of a Client and a FileSet to backup, the Schedule for the Job, where the data are to be stored, and what media Pool can be used. In effect, each Job resource must specify What, Where, How, and When or FileSet, Storage, Backup/Restore/Level, and Schedule respectively. Note, the FileSet must be specified for a restore job for historical reasons, but it is no longer used.

Only a single type (**Backup, Restore, ...**) can be specified for any job. If you want to backup multiple FileSets on the same Client or multiple Clients, you must define a Job for each one.

Note, you define only a single Job to do the Full, Differential, and Incremental backups since the different backup levels are tied together by a unique Job name. Normally, you will have only one Job per Client, but if a client has a really huge number of files (more than several million), you might want to split it into to Jobs each with a different FileSet covering only part of the total files.

Multiple Storage daemons are not currently supported for Jobs, so if you do want to use multiple storage daemons, you will need to create a different Job and ensure that for each Job that the combination of Client and FileSet are unique. The Client and FileSet are what Bacula uses to restore a client, so if there are multiple Jobs with the same Client and FileSet or multiple Storage daemons that are used, the restore will not work. This problem can be resolved by defining multiple FileSet definitions (the names must be different, but the contents of the FileSets may be the same).

Job Start of the Job resource. At least one Job resource is required.

Name = `<name>` The Job name. This name can be specified on the **Run** command in the console program to start a job. If the name contains spaces, it must be specified between quotes. It is generally a good idea to give your job the same name as the Client that it will backup. This permits easy identification of jobs.

When the job actually runs, the unique Job Name will consist of the name you specify here followed by the date and time the job was scheduled for execution. This directive is required.

Enabled = `<yes|no>` This directive allows you to enable or disable automatic execution via the scheduler of a Job.

Type = `<job-type>` The **Type** directive specifies the Job type, which may be one of the following: **Backup, Restore, Verify, or Admin**. This directive is required. Within a particular Job Type, there are also Levels as discussed in the next item.

Backup Run a backup Job. Normally you will have at least one Backup job for each client you want to save. Normally, unless you turn off cataloging, most all the important statistics and data concerning files backed up will be placed in the catalog.

Restore Run a restore Job. Normally, you will specify only one Restore job which acts as a sort of prototype that you will modify using the console program in order to perform restores. Although certain basic information from a Restore job is saved in the catalog, it is very minimal compared to the information stored for a Backup job – for example, no File database entries are generated since no Files are saved.

Restore jobs cannot be automatically started by the scheduler as is the case for Backup, Verify and Admin jobs. To restore files, you must use the **restore** command in the console.

Verify Run a verify Job. In general, **verify** jobs permit you to compare the contents of the catalog to the file system, or to what was backed up. In addition, to verifying that a tape that was written can be read, you can also use **verify** as a sort of tripwire intrusion detection.

Admin Run an admin Job. An **Admin** job can be used to periodically run catalog pruning, if you do not want to do it at the end of each **Backup** Job. Although an Admin job is recorded in the catalog, very little data is saved.

Level = <job-level> The Level directive specifies the default Job level to be run. Each different Job Type (Backup, Restore, ...) has a different set of Levels that can be specified. The Level is normally overridden by a different value that is specified in the **Schedule** resource. This directive is not required, but must be specified either by a **Level** directive or as an override specified in the **Schedule** resource. For a **Backup** Job, the Level may be one of the following:

Full When the Level is set to Full all files in the FileSet whether or not they have changed will be backed up.

Incremental When the Level is set to Incremental all files specified in the FileSet that have changed since the last successful backup of the the same Job using the same FileSet and Client, will be backed up. If the Director cannot find a previous valid Full backup then the job will be upgraded into a Full backup. When the Director looks for a valid backup record in the catalog database, it looks for a previous Job with:

- The same Job name.
- The same Client name.
- The same FileSet (any change to the definition of the FileSet such as adding or deleting a file in the Include or Exclude sections constitutes a different FileSet.
- The Job was a Full, Differential, or Incremental backup.
- The Job terminated normally (i.e. did not fail or was not canceled).
- The Job started no longer ago than **Max Full Interval**.

If all the above conditions do not hold, the Director will upgrade the Incremental to a Full save. Otherwise, the Incremental backup will be performed as requested.

The File daemon (Client) decides which files to backup for an Incremental backup by comparing start time of the prior Job (Full, Differential, or Incremental) against the time each file was last "modified" (st_mtime) and the time its attributes were last "changed" (st_ctime). If the file was modified or its attributes changed on or after this start time, it will then be backed up.

Some virus scanning software may change st_ctime while doing the scan. For example, if the virus scanning program attempts to reset the access time (st_atime), which Bacula does not use, it will cause st_ctime to change and hence Bacula will backup the file during an Incremental or Differential backup. In the case of Sophos virus scanning, you can prevent it from resetting the access time (st_atime) and hence changing st_ctime by using the **--no-reset-atime** option. For other software, please see their manual.

When Bacula does an Incremental backup, all modified files that are still on the system are backed up. However, any file that has been deleted since the last Full backup remains in the Bacula catalog, which means that if between a Full save and the time you do a restore, some files are deleted, those deleted files will also be restored. The deleted files will no longer appear in the catalog after doing another Full save.

In addition, if you move a directory rather than copy it, the files in it do not have their modification time (st_mtime) or their attribute change time (st_ctime) changed. As a consequence, those files



will probably not be backed up by an Incremental or Differential backup which depend solely on these time stamps. If you move a directory, and wish it to be properly backed up, it is generally preferable to copy it, then delete the original.

However, to manage deleted files or directories changes in the catalog during an Incremental backup you can use **accurate** mode. This is quite memory consuming process. See Accurate mode for more details.

Differential When the Level is set to Differential all files specified in the FileSet that have changed since the last successful Full backup of the same Job will be backed up. If the Director cannot find a valid previous Full backup for the same Job, FileSet, and Client, backup, then the Differential job will be upgraded into a Full backup. When the Director looks for a valid Full backup record in the catalog database, it looks for a previous Job with:

- The same Job name.
- The same Client name.
- The same FileSet (any change to the definition of the FileSet such as adding or deleting a file in the Include or Exclude sections constitutes a different FileSet.
- The Job was a FULL backup.
- The Job terminated normally (i.e. did not fail or was not canceled).
- The Job started no longer ago than **Max Full Interval**.

If all the above conditions do not hold, the Director will upgrade the Differential to a Full save. Otherwise, the Differential backup will be performed as requested.

The File daemon (Client) decides which files to backup for a differential backup by comparing the start time of the prior Full backup Job against the time each file was last "modified" (`st_mtime`) and the time its attributes were last "changed" (`st_ctime`). If the file was modified or its attributes were changed on or after this start time, it will then be backed up. The start time used is displayed after the **Since** on the Job report. In rare cases, using the start time of the prior backup may cause some files to be backed up twice, but it ensures that no change is missed. As with the Incremental option, you should ensure that the clocks on your server and client are synchronized or as close as possible to avoid the possibility of a file being skipped. Note, on versions 1.33 or greater Bacula automatically makes the necessary adjustments to the time between the server and the client so that the times Bacula uses are synchronized.

When Bacula does a Differential backup, all modified files that are still on the system are backed up. However, any file that has been deleted since the last Full backup remains in the Bacula catalog, which means that if between a Full save and the time you do a restore, some files are deleted, those deleted files will also be restored. The deleted files will no longer appear in the catalog after doing another Full save. However, to remove deleted files from the catalog during a Differential backup is quite a time consuming process and not currently implemented in Bacula. It is, however, a planned future feature.

As noted above, if you move a directory rather than copy it, the files in it do not have their modification time (`st_mtime`) or their attribute change time (`st_ctime`) changed. As a consequence, those files will probably not be backed up by an Incremental or Differential backup which depend solely on these time stamps. If you move a directory, and wish it to be properly backed up, it is generally preferable to copy it, then delete the original. Alternatively, you can move the directory, then use the **touch** program to update the timestamps.

However, to manage deleted files or directories changes in the catalog during an Differential backup you can use **accurate** mode. This is quite memory consuming process. See Accurate mode for more details.

Every once and a while, someone asks why we need Differential backups as long as Incremental backups pickup all changed files. There are possibly many answers to this question, but the one that is the most important for me is that a Differential backup effectively merges all the Incremental and Differential backups since the last Full backup into a single Differential backup. This has two effects: 1. It gives some redundancy since the old backups could be used if the merged backup cannot be read. 2. More importantly, it reduces the number of Volumes that are needed to do a restore effectively eliminating the need to read all the volumes on which the preceding Incremental and Differential backups since the last Full are done.

For a **Restore** Job, no level needs to be specified.

For a **Verify** Job, the Level may be one of the following:

InitCatalog does a scan of the specified **FileSet** and stores the file attributes in the Catalog database. Since no file data is saved, you might ask why you would want to do this. It turns out to be a very simple and easy way to have a **Tripwire** like feature using **Bacula**. In other words, it allows you to save the state of a set of files defined by the **FileSet** and later check to see if those files have been modified or deleted and if any new files have been added. This can be used to detect system intrusion. Typically you would specify a **FileSet** that contains the set of system files that should not change (e.g. /sbin, /boot, /lib, /bin, ...). Normally, you run the **InitCatalog** level verify one time when your system is first setup, and then once again after each modification (upgrade) to your system. Thereafter, when you want to check the state of your system files, you use a **Verify level = Catalog**. This compares the results of your **InitCatalog** with the current state of the files.

Catalog Compares the current state of the files against the state previously saved during an **InitCatalog**. Any discrepancies are reported. The items reported are determined by the **verify** options specified on the **Include** directive in the specified **FileSet** (see the **FileSet** resource below for more details). Typically this command will be run once a day (or night) to check for any changes to your system files.

Please note! If you run two Verify Catalog jobs on the same client at the same time, the results will certainly be incorrect. This is because Verify Catalog modifies the Catalog database while running in order to track new files.

VolumeToCatalog This level causes Bacula to read the file attribute data written to the Volume from the last backup Job for the job specified on the **VerifyJob** directive. The file attribute data are compared to the values saved in the Catalog database and any differences are reported. This is similar to the **DiskToCatalog** level except that instead of comparing the disk file attributes to the catalog database, the attribute data written to the Volume is read and compared to the catalog database. Although the attribute data including the signatures (MD5 or SHA1) are compared, the actual file data is not compared (it is not in the catalog).

Please note! If you run two Verify VolumeToCatalog jobs on the same client at the same time, the results will certainly be incorrect. This is because the Verify VolumeToCatalog modifies the Catalog database while running.

DiskToCatalog This level causes Bacula to read the files as they currently are on disk, and to compare the current file attributes with the attributes saved in the catalog from the last backup for the job specified on the **VerifyJob** directive. This level differs from the **VolumeToCatalog** level described above by the fact that it doesn't compare against a previous Verify job but against a previous backup. When you run this level, you must supply the verify options on your Include statements. Those options determine what attribute fields are compared.

This command can be very useful if you have disk problems because it will compare the current state of your disk against the last successful backup, which may be several jobs.

Note, the current implementation (1.32c) does not identify files that have been deleted.

Accurate = <yes|no> In accurate mode, the File daemon knows exactly which files were present after the last backup. So it is able to handle deleted or renamed files.

When restoring a FileSet for a specified date (including "most recent"), Bacula is able to restore exactly the files and directories that existed at the time of the last backup prior to that date including ensuring that deleted files are actually deleted, and renamed directories are restored properly.

In this mode, the File daemon must keep data concerning all files in memory. So If you do not have sufficient memory, the backup may either be terribly slow or fail.

For 500.000 files (a typical desktop linux system), it will require approximately 64 Megabytes of RAM on your File daemon to hold the required information.

Verify Job = <Job-Resource-Name> If you run a verify job without this directive, the last job run will be compared with the catalog, which means that you must immediately follow a backup by a verify command. If you specify a **Verify Job** Bacula will find the last job with that name that ran. This permits you to run all your backups, then run Verify jobs on those that you wish to be verified (most often a **VolumeToCatalog**) so that the tape just written is re-read.

JobDefs = <JobDefs-Resource-Name> If a JobDefs-Resource-Name is specified, all the values contained in the named JobDefs resource will be used as the defaults for the current Job. Any value that you explicitly define in the current Job resource, will override any defaults specified in the JobDefs



resource. The use of this directive permits writing much more compact Job resources where the bulk of the directives are defined in one or more JobDefs. This is particularly useful if you have many similar Jobs but with minor variations such as different Clients. A simple example of the use of JobDefs is provided in the default bacula-dir.conf file.

Bootstrap = **<bootstrap-file>** The Bootstrap directive specifies a bootstrap file that, if provided, will be used during **Restore** Jobs and is ignored in other Job types. The **bootstrap** file contains the list of tapes to be used in a restore Job as well as which files are to be restored. Specification of this directive is optional, and if specified, it is used only for a restore job. In addition, when running a Restore job from the console, this value can be changed.

If you use the **Restore** command in the Console program, to start a restore job, the **bootstrap** file will be created automatically from the files you select to be restored.

For additional details of the **bootstrap** file, please see Restoring Files with the Bootstrap File chapter of this manual.

Write Bootstrap = **<bootstrap-file-specification>** The **writebootstrap** directive specifies a file name where Bacula will write a **bootstrap** file for each Backup job run. This directive applies only to Backup Jobs. If the Backup job is a Full save, Bacula will erase any current contents of the specified file before writing the bootstrap records. If the Job is an Incremental or Differential save, Bacula will append the current bootstrap record to the end of the file.

Using this feature, permits you to constantly have a bootstrap file that can recover the current state of your system. Normally, the file specified should be a mounted drive on another machine, so that if your hard disk is lost, you will immediately have a bootstrap record available. Alternatively, you should copy the bootstrap file to another machine after it is updated. Note, it is a good idea to write a separate bootstrap file for each Job backed up including the job that backs up your catalog database.

If the **bootstrap-file-specification** begins with a vertical bar (**|**), Bacula will use the specification as the name of a program to which it will pipe the bootstrap record. It could for example be a shell script that emails you the bootstrap record.

On versions 1.39.22 or greater, before opening the file or executing the specified command, Bacula performs character substitution like in RunScript directive. To automatically manage your bootstrap files, you can use this in your **JobDefs** resources:

```
JobDefs {
  Write Bootstrap = "%c_%n.bsr"
  ...
}
```

For more details on using this file, please see the chapter entitled The Bootstrap File of this manual.

Client = **<client-resource-name>** The Client directive specifies the Client (File daemon) that will be used in the current Job. Only a single Client may be specified in any one Job. The Client runs on the machine to be backed up, and sends the requested files to the Storage daemon for backup, or receives them when restoring. For additional details, see the Client Resource section of this chapter. This directive is required.

FileSet = **<FileSet-resource-name>** The FileSet directive specifies the FileSet that will be used in the current Job. The FileSet specifies which directories (or files) are to be backed up, and what options to use (e.g. compression, ...). Only a single FileSet resource may be specified in any one Job. For additional details, see the FileSet Resource section of this chapter. This directive is required.

Base = **<job-resource-name, ...>** The Base directive permits to specify the list of jobs that will be used during Full backup as base. This directive is optional. See the Base Job chapter for more information.

Messages = **<messages-resource-name>** The Messages directive defines what Messages resource should be used for this job, and thus how and where the various messages are to be delivered. For example, you can direct some messages to a log file, and others can be sent by email. For additional details, see the Messages Resource Chapter of this manual. This directive is required.

Pool = **<pool-resource-name>** The Pool directive defines the pool of Volumes where your data can be backed up. Many Bacula installations will use only the **Default** pool. However, if you want to specify a different set of Volumes for different Clients or different Jobs, you will probably want to use Pools. For additional details, see the Pool Resource section of this chapter. This directive is required.

Full Backup Pool = `<pool-resource-name>` The *Full Backup Pool* specifies a Pool to be used for Full backups. It will override any Pool specification during a Full backup. This directive is optional.

Differential Backup Pool = `<pool-resource-name>` The *Differential Backup Pool* specifies a Pool to be used for Differential backups. It will override any Pool specification during a Differential backup. This directive is optional.

Incremental Backup Pool = `<pool-resource-name>` The *Incremental Backup Pool* specifies a Pool to be used for Incremental backups. It will override any Pool specification during an Incremental backup. This directive is optional.

Schedule = `<schedule-name>` The Schedule directive defines what schedule is to be used for the Job. The schedule in turn determines when the Job will be automatically started and what Job level (i.e. Full, Incremental, ...) is to be run. This directive is optional, and if left out, the Job can only be started manually using the Console program. Although you may specify only a single Schedule resource for any one job, the Schedule resource may contain multiple **Run** directives, which allow you to run the Job at many different times, and each **run** directive permits overriding the default Job Level Pool, Storage, and Messages resources. This gives considerable flexibility in what can be done with a single Job. For additional details, see the Schedule Resource Chapter of this manual.

Storage = `<storage-resource-name>` The Storage directive defines the name of the storage services where you want to backup the FileSet data. For additional details, see the Storage Resource Chapter of this manual. The Storage resource may also be specified in the Job's Pool resource, in which case the value in the Pool resource overrides any value in the Job. This Storage resource definition is not required by either the Job resource or in the Pool, but it must be specified in one or the other, if not an error will result.

Max Start Delay = `<time>` The time specifies the maximum delay between the scheduled time and the actual start time for the Job. For example, a job can be scheduled to run at 1:00am, but because other jobs are running, it may wait to run. If the delay is set to 3600 (one hour) and the job has not begun to run by 2:00am, the job will be canceled. This can be useful, for example, to prevent jobs from running during day time hours. The default is 0 which indicates no limit.

Max Run Time = `<time>` The time specifies the maximum allowed time that a job may run, counted from when the job starts, (**not** necessarily the same as when the job was scheduled).

By default, the the watchdog thread will kill any Job that has run more than 6 days. The maximum watchdog timeout is independent of MaxRunTime and cannot be changed.

Incremental—Differential Max Wait Time = `<time>` Theses directives have been deprecated in favor of `Incremental|Differential Max Run Time` since bacula 2.3.18.

Incremental Max Run Time = `<time>` The time specifies the maximum allowed time that an Incremental backup job may run, counted from when the job starts, (**not** necessarily the same as when the job was scheduled).

Differential Max Wait Time = `<time>` The time specifies the maximum allowed time that a Differential backup job may run, counted from when the job starts, (**not** necessarily the same as when the job was scheduled).

Max Run Sched Time = `<time>` The time specifies the maximum allowed time that a job may run, counted from when the job was scheduled. This can be useful to prevent jobs from running during working hours. We can see it like `Max Start Delay + Max Run Time`.

Max Wait Time = `<time>` The time specifies the maximum allowed time that a job may block waiting for a resource (such as waiting for a tape to be mounted, or waiting for the storage or file daemons to perform their duties), counted from the when the job starts, (**not** necessarily the same as when the job was scheduled). This directive works as expected since bacula 2.3.18.

Maximum Bandwidth = `<speed>` The speed parameter specifies the maximum allowed bandwidth that a job may use. The speed parameter should be specified in k/s, kb/s, m/s or mb/s.

Max Full Interval = `<time>` The time specifies the maximum allowed age (counting from start time) of the most recent successful Full backup that is required in order to run Incremental or Differential backup jobs. If the most recent Full backup is older than this interval, Incremental and Differential backups will be upgraded to Full backups automatically. If this directive is not present, or specified as 0, then the age of the previous Full backup is not considered.

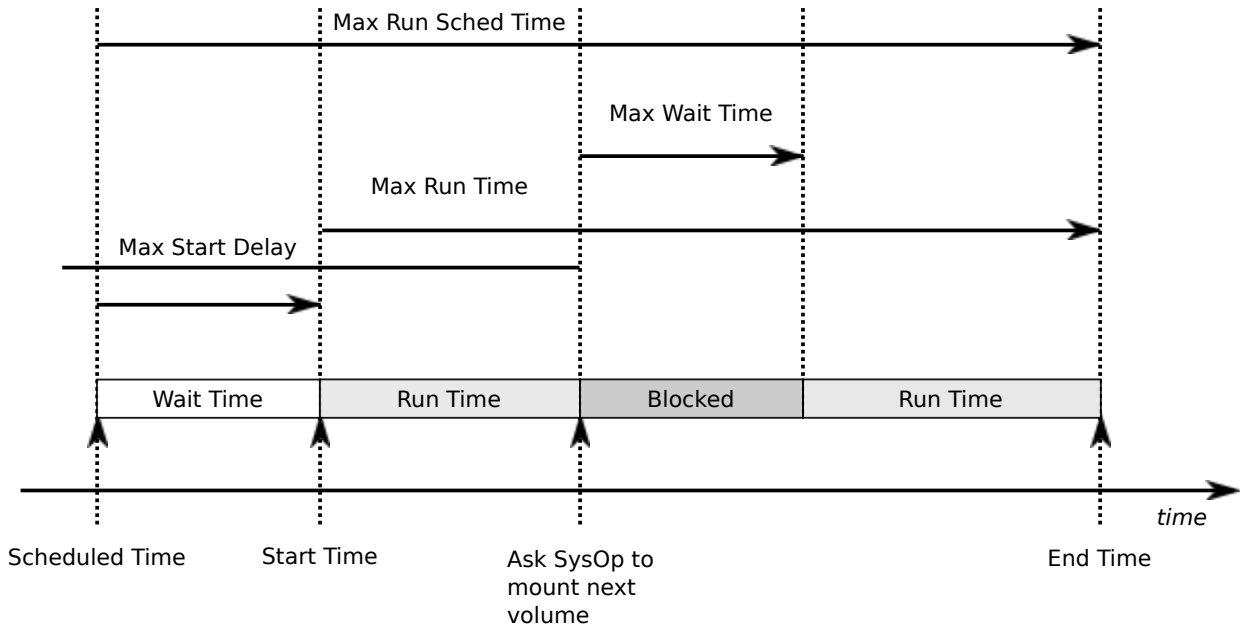

Figure 14.1: Job time control directives

Prefer Mounted Volumes = `<yes|no>` If the Prefer Mounted Volumes directive is set to **yes** (default **yes**), the Storage daemon is requested to select either an Autochanger or a drive with a valid Volume already mounted in preference to a drive that is not ready. This means that all jobs will attempt to append to the same Volume (providing the Volume is appropriate – right Pool, ... for that job), unless you are using multiple pools. If no drive with a suitable Volume is available, it will select the first available drive. Note, any Volume that has been requested to be mounted, will be considered valid as a mounted volume by another job. This if multiple jobs start at the same time and they all prefer mounted volumes, the first job will request the mount, and the other jobs will use the same volume.

If the directive is set to **no**, the Storage daemon will prefer finding an unused drive, otherwise, each job started will append to the same Volume (assuming the Pool is the same for all jobs). Setting Prefer Mounted Volumes to **no** can be useful for those sites with multiple drive autochangers that prefer to maximize backup throughput at the expense of using additional drives and Volumes. This means that the job will prefer to use an unused drive rather than use a drive that is already in use.

Despite the above, we recommend against setting this directive to **no** since it tends to add a lot of swapping of Volumes between the different drives and can easily lead to deadlock situations in the Storage daemon. We will accept bug reports against it, but we cannot guarantee that we will be able to fix the problem in a reasonable time.

A better alternative for using multiple drives is to use multiple pools so that Bacula will be forced to mount Volumes from those Pools on different drives.

Prune Jobs = `<yes|no>` Normally, pruning of Jobs from the Catalog is specified on a Client by Client basis in the Client resource with the **AutoPrune** directive. If this directive is specified (not normally) and the value is **yes**, it will override the value specified in the Client resource. The default is **no**.

Prune Files = `<yes|no>` Normally, pruning of Files from the Catalog is specified on a Client by Client basis in the Client resource with the **AutoPrune** directive. If this directive is specified (not normally) and the value is **yes**, it will override the value specified in the Client resource. The default is **no**.

Prune Volumes = `<yes|no>` Normally, pruning of Volumes from the Catalog is specified on a Pool by Pool basis in the Pool resource with the **AutoPrune** directive. Note, this is different from File and Job pruning which is done on a Client by Client basis. If this directive is specified (not normally) and the value is **yes**, it will override the value specified in the Pool resource. The default is **no**.

RunScript {`<body-of-runscrip>`} The RunScript directive behaves like a resource in that it requires opening and closing braces around a number of directives that make up the body of the runscrip.



The specified **Command** (see below for details) is run as an external program prior or after the current Job. This is optional. By default, the program is executed on the Client side like in `ClientRunXXXJob`.

Console options are special commands that are sent to the director instead of the OS. At this time, console command outputs are redirected to log with the jobid 0.

You can use following console command : `delete`, `disable`, `enable`, `estimate`, `list`, `l1ist`, `memory`, `prune`, `purge`, `reload`, `status`, `setdebug`, `show`, `time`, `trace`, `update`, `version`, `.client`, `.jobs`, `.pool`, `.storage`. See console chapter for more information. You need to specify needed information on command line, nothing will be prompted. Example :

```
Console = "prune files client=%c"
Console = "update stats age=3"
```

You can specify more than one Command/Console option per RunScript.

You can use following options may be specified in the body of the runscript:

Options	Value	Default	Information
Runs On Success	Yes / No	<i>Yes</i>	Run command if Job-Status is successful
Runs On Failure	Yes / No	<i>No</i>	Run command if Job-Status isn't successful
Runs On Client	Yes / No	<i>Yes</i>	Run command on client
Runs When	Before — After — Always — <i>AfterVSS</i>	<i>Never</i>	When run commands
Fail Job On Error	Yes/No	<i>Yes</i>	Fail job if script returns something different from 0
Command			Path to your script
Console			Console command

Any output sent by the command to standard output will be included in the Bacula job report. The command string must be a valid program name or name of a shell script.

In addition, the command string is parsed then fed to the OS, which means that the path will be searched to execute your specified command, but there is no shell interpretation, as a consequence, if you invoke complicated commands or want any shell features such as redirection or piping, you must call a shell script and do it inside that script.

Before submitting the specified command to the operating system, Bacula performs character substitution of the following characters:

```
%% = %
%b = Job Bytes
%c = Client's name
%C = If the job is a Cloned job (Only on director side)
%d = Daemon's name (Such as host-dir or host-fd)
%D = Director's name (Also valid on file daemon)
%e = Job Exit Status
%f = Job FileSet (Only on director side)
%F = Job Files
%h = Client address
%i = JobId
%j = Unique Job id
%l = Job Level
%n = Job name
%p = Pool name (Only on director side)
%P = Current PID
%s = Since time
```



```
%t = Job type (Backup, ...)
%v = Volume name (Only on director side)
%w = Storage name (Only on director side)
%x = Spooling enabled? ("yes" or "no")
```

Some character substitutions are not available in all situations. The Job Exit Status code %e edits the following values:

- OK
- Error
- Fatal Error
- Canceled
- Differences
- Unknown term code

Thus if you edit it on a command line, you will need to enclose it within some sort of quotes.

You can use these following shortcuts:

Keyword	Runs on Success	Runs on Failure	Fail job on Error	Runs on Client	Runs When
Run Before Job			Yes	No	Before
Run After Job	Yes	No		No	After
Run After Failed Job	No	Yes		No	After
Client Run Before Job			Yes	Yes	Before
Client Run After Job	Yes	No		Yes	After

Examples:

```
RunScript {
  RunWhen = Before
  FailJobOnError = No
  Command = "/etc/init.d/apache stop"
}
```

```
RunScript {
  RunWhen = After
  RunOnFailure = yes
  Command = "/etc/init.d/apache start"
}
```

Notes about ClientRunBeforeJob

For compatibility reasons, with this shortcut, the command is executed directly when the client receive it. And if the command is in error, other remote runscripts will be discarded. To be sure that all commands will be sent and executed, you have to use RunScript syntax.

Special Windows Considerations

You can run scripts just after snapshots initializations with *AfterVSS* keyword.

In addition, for a Windows client, please take note that you must ensure a correct path to your script. The script or program can be a .com, .exe or a .bat file. If you just put the program name in then Bacula will search using the same rules that cmd.exe uses (current directory, Bacula bin directory, and PATH). It will even try the different extensions in the same order as cmd.exe. The command can be anything that cmd.exe or command.com will recognize as an executable file.

However, if you have slashes in the program name then Bacula figures you are fully specifying the name, so you must also explicitly add the three character extension.



The command is run in a Win32 environment, so Unix like commands will not work unless you have installed and properly configured Cygwin in addition to and separately from Bacula.

The System %Path% will be searched for the command. (under the environment variable dialog you have both System Environment and User Environment, we believe that only the System environment will be available to bacula-fd, if it is running as a service.)

System environment variables can be referenced with %var% and used as either part of the command name or arguments.

So if you have a script in the Bacula bin directory then the following lines should work fine:

```

Client Run Before Job = systemstate
or
Client Run Before Job = systemstate.bat
or
Client Run Before Job = "systemstate"
or
Client Run Before Job = "systemstate.bat"
or
ClientRunBeforeJob = "\"C:/Program Files/Bacula/systemstate.bat\""
```

The outer set of quotes is removed when the configuration file is parsed. You need to escape the inner quotes so that they are there when the code that parses the command line for execution runs so it can tell what the program name is.

```

ClientRunBeforeJob = "\"C:/Program Files/Software
Vendor/Executable\" /arg1 /arg2 \"foo bar\""
```

The special characters

```
&<>()@^|
```

will need to be quoted, if they are part of a filename or argument.

If someone is logged in, a blank "command" window running the commands will be present during the execution of the command.

Some Suggestions from Phil Stracchino for running on Win32 machines with the native Win32 File daemon:

1. You might want the ClientRunBeforeJob directive to specify a .bat file which runs the actual client-side commands, rather than trying to run (for example) regedit /e directly.
2. The batch file should explicitly 'exit 0' on successful completion.
3. The path to the batch file should be specified in Unix form:
ClientRunBeforeJob = "c:/bacula/bin/systemstate.bat"
rather than DOS/Windows form:
ClientRunBeforeJob =
"c:\bacula\bin\systemstate.bat" INCORRECT

For Win32, please note that there are certain limitations:

```
ClientRunBeforeJob = "C:/Program Files/Bacula/bin/pre-exec.bat"
```

Lines like the above do not work because there are limitations of cmd.exe that is used to execute the command. Bacula prefixes the string you supply with **cmd.exe /c** . To test that your command works you should type **cmd /c "C:/Program Files/test.exe"** at a cmd prompt and see what happens. Once the command is correct insert a backslash (\) before each double quote ("), and then put quotes around the whole thing when putting it in the director's .conf file. You either need to have only one set of quotes or else use the short name and don't put quotes around the command path.

Below is the output from cmd's help as it relates to the command line passed to the /c option.

If /C or /K is specified, then the remainder of the command line after the switch is processed as a command line, where the following logic is used to process quote (") characters:

1. If all of the following conditions are met, then quote characters on the command line are preserved:



- no /S switch.
 - exactly two quote characters.
 - no special characters between the two quote characters, where special is one of:
`&<>()@~|`
 - there are one or more whitespace characters between the the two quote characters.
 - the string between the two quote characters is the name of an executable file.
2. Otherwise, old behavior is to see if the first character is a quote character and if so, strip the leading character and remove the last quote character on the command line, preserving any text after the last quote character.

The following example of the use of the Client Run Before Job directive was submitted by a user: You could write a shell script to back up a DB2 database to a FIFO. The shell script is:

```
#!/bin/sh
# ===== backupdb.sh
DIR=/u01/mercuryd

mkfifo $DIR/dbpipe
db2 BACKUP DATABASE mercuryd TO $DIR/dbpipe WITHOUT PROMPTING &
sleep 1
```

The following line in the Job resource in the bacula-dir.conf file:

```
Client Run Before Job = "su - mercuryd -c \" /u01/mercuryd/backupdb.sh '%t'
'%1'\""
```

When the job is run, you will get messages from the output of the script stating that the backup has started. Even though the command being run is backgrounded with `&`, the job will block until the "db2 BACKUP DATABASE" command, thus the backup stalls.

To remedy this situation, the "db2 BACKUP DATABASE" line should be changed to the following:

```
db2 BACKUP DATABASE mercuryd TO $DIR/dbpipe WITHOUT PROMPTING > $DIR/backup.log
2>&1 < /dev/null &
```

It is important to redirect the input and outputs of a backgrounded command to `/dev/null` to prevent the script from blocking.

Run Before Job = <command> The specified **command** is run as an external program prior to running the current Job. This directive is not required, but if it is defined, and if the exit code of the program run is non-zero, the current Bacula job will be canceled.

```
Run Before Job = "echo test"
```

it's equivalent to :

```
RunScript {
  Command = "echo test"
  RunsOnClient = No
  RunsWhen = Before
}
```

Lutz Kittler has pointed out that using the RunBeforeJob directive can be a simple way to modify your schedules during a holiday. For example, suppose that you normally do Full backups on Fridays, but Thursday and Friday are holidays. To avoid having to change tapes between Thursday and Friday when no one is in the office, you can create a RunBeforeJob that returns a non-zero status on Thursday and zero on all other days. That way, the Thursday job will not run, and on Friday the tape you inserted on Wednesday before leaving will be used.



Run After Job = <command> The specified **command** is run as an external program if the current job terminates normally (without error or without being canceled). This directive is not required. If the exit code of the program run is non-zero, Bacula will print a warning message. Before submitting the specified command to the operating system, Bacula performs character substitution as described above for the **RunScript** directive.

An example of the use of this directive is given in the **Tips** chapter (chapter 2.4 on page 19) of the Bacula Community Problem Resolution Guide.

See the **Run After Failed Job** if you want to run a script after the job has terminated with any non-normal status.

Run After Failed Job = <command> The specified **command** is run as an external program after the current job terminates with any error status. This directive is not required. The command string must be a valid program name or name of a shell script. If the exit code of the program run is non-zero, Bacula will print a warning message. Before submitting the specified command to the operating system, Bacula performs character substitution as described above for the **RunScript** directive. Note, if you wish that your script will run regardless of the exit status of the Job, you can use this :

```
RunScript {
  Command = "echo test"
  RunsWhen = After
  RunsOnFailure = yes
  RunsOnClient = no
  RunsOnSuccess = yes    # default, you can drop this line
}
```

An example of the use of this directive is given in the **Tips** chapter (chapter 2.4 on page 19) of the Bacula Community Problem Resolution Guide.

Client Run Before Job = <command> This directive is the same as **Run Before Job** except that the program is run on the client machine. The same restrictions apply to Unix systems as noted above for the **RunScript**.

Client Run After Job = <command> The specified **command** is run on the client machine as soon as data spooling is complete in order to allow restarting applications on the client as soon as possible.

Note, please see the notes above in **RunScript** concerning Windows clients.

Rerun Failed Levels = <yes|no> If this directive is set to **yes** (default **no**), and Bacula detects that a previous job at a higher level (i.e. Full or Differential) has failed, the current job level will be upgraded to the higher level. This is particularly useful for Laptops where they may often be unreachable, and if a prior Full save has failed, you wish the very next backup to be a Full save rather than whatever level it is started as.

There are several points that must be taken into account when using this directive: first, a failed job is defined as one that has not terminated normally, which includes any running job of the same name (you need to ensure that two jobs of the same name do not run simultaneously); secondly, the **Ignore FileSet Changes** directive is not considered when checking for failed levels, which means that any FileSet change will trigger a rerun.

Spool Data = <yes|no> If this directive is set to **yes** (default **no**), the Storage daemon will be requested to spool the data for this Job to disk rather than write it directly to the Volume (normally a tape).

Thus the data is written in large blocks to the Volume rather than small blocks. This directive is particularly useful when running multiple simultaneous backups to tape. Once all the data arrives or the spool files' maximum sizes are reached, the data will be despoiled and written to tape.

Spooling data prevents interleaving data from several job and reduces or eliminates tape drive stop and start commonly known as "shoe-shine".

We don't recommend using this option if you are writing to a disk file using this option will probably just slow down the backup jobs.

NOTE: When this directive is set to **yes**, Spool Attributes is also automatically set to **yes**.



Spool Attributes = <yes|no> The default is set to **no**, which means that the File attributes are sent by the Storage daemon to the Director as they are stored on tape. However, if you want to avoid the possibility that database updates will slow down writing to the tape, you may want to set the value to **yes**, in which case the Storage daemon will buffer the File attributes and Storage coordinates to a temporary file in the Working Directory, then when writing the Job data to the tape is completed, the attributes and storage coordinates will be sent to the Director.

NOTE: When Spool Data is set to yes, Spool Attributes is also automatically set to yes.

SpoolSize=*bytes* where the bytes specify the maximum spool size for this job. The default is take from Device Maximum Spool Size limit. This directive is available only in Bacula version 2.3.5 or later.

Where = <directory> This directive applies only to a Restore job and specifies a prefix to the directory name of all files being restored. This permits files to be restored in a different location from which they were saved. If **Where** is not specified or is set to backslash (/), the files will be restored to their original location. By default, we have set **Where** in the example configuration files to be **/tmp/bacula-restores**. This is to prevent accidental overwriting of your files.

Add Prefix = <directory> This directive applies only to a Restore job and specifies a prefix to the directory name of all files being restored. This will use File Relocation feature implemented in Bacula 2.1.8 or later.

Add Suffix = <extention> This directive applies only to a Restore job and specifies a suffix to all files being restored. This will use File Relocation feature implemented in Bacula 2.1.8 or later.

Using **Add Suffix=.old**, **/etc/passwd** will be restored to **/etc/passwd.old**

Strip Prefix = <directory> This directive applies only to a Restore job and specifies a prefix to remove from the directory name of all files being restored. This will use the File Relocation feature implemented in Bacula 2.1.8 or later.

Using **Strip Prefix=/etc**, **/etc/passwd** will be restored to **/passwd**

Under Windows, if you want to restore **c:/files** to **d:/files**, you can use :

```
Strip Prefix = c:  
Add Prefix = d:
```

RegexWhere = <expressions> This directive applies only to a Restore job and specifies a regex filename manipulation of all files being restored. This will use File Relocation feature implemented in Bacula 2.1.8 or later.

For more informations about how use this option, see this.

Replace = <replace-option> This directive applies only to a Restore job and specifies what happens when Bacula wants to restore a file or directory that already exists. You have the following options for **replace-option**:

always when the file to be restored already exists, it is deleted and then replaced by the copy that was backed up. This is the default value.

ifnewer if the backed up file (on tape) is newer than the existing file, the existing file is deleted and replaced by the back up.

ifolder if the backed up file (on tape) is older than the existing file, the existing file is deleted and replaced by the back up.

never if the backed up file already exists, Bacula skips restoring this file.

Prefix Links=<yes|no> If a **Where** path prefix is specified for a recovery job, apply it to absolute links as well. The default is **No**. When set to **Yes** then while restoring files to an alternate directory, any absolute soft links will also be modified to point to the new alternate directory. Normally this is what is desired – i.e. everything is self consistent. However, if you wish to later move the files to their original locations, all files linked with absolute names will be broken.



Maximum Concurrent Jobs = `<number>` where `<number>` is the maximum number of Jobs from the current Job resource that can run concurrently. Note, this directive limits only Jobs with the same name as the resource in which it appears. Any other restrictions on the maximum concurrent jobs such as in the Director, Client, or Storage resources will also apply in addition to the limit specified here. The default is set to 1, but you may set it to a larger number. We strongly recommend that you read the WARNING documented under Maximum Concurrent Jobs in the Director's resource.

Reschedule On Error = `<yes|no>` If this directive is enabled, and the job terminates in error, the job will be rescheduled as determined by the **Reschedule Interval** and **Reschedule Times** directives. If you cancel the job, it will not be rescheduled. The default is **no** (i.e. the job will not be rescheduled). This specification can be useful for portables, laptops, or other machines that are not always connected to the network or switched on.

Reschedule Interval = `<time-specification>` If you have specified **Reschedule On Error** = **yes** and the job terminates in error, it will be rescheduled after the interval of time specified by **time-specification**. See the time specification formats in the Configure chapter for details of time specifications. If no interval is specified, the job will not be rescheduled on error. The default Reschedule Interval is 30 minutes (1800 seconds).

Reschedule Times = `<count>` This directive specifies the maximum number of times to reschedule the job. If it is set to zero (the default) the job will be rescheduled an indefinite number of times.

Allow Duplicate Jobs = `<yes|no>` A duplicate job in the sense we use it here means a second or subsequent job with the same name starts. This happens most frequently when the first job runs longer than expected because no tapes are available.

If this directive is enabled duplicate jobs will be run. If the directive is set to **no** (default) then only one job of a given name may run at one time, and the action that Bacula takes to ensure only one job runs is determined by the other directives (see below).

If **Allow Duplicate Jobs** is set to **no** and two jobs are present and none of the three directives given below permit cancelling a job, then the current job (the second one started) will be cancelled.

Allow Higher Duplicates = `<yes|no>` This directive was implemented in version 5.0.0, but does not work as expected. If used, it should always be set to **no**. In later versions of Bacula the directive is disabled (disregarded).

Cancel Lower Level Duplicates = `<yes|no>` If **Allow Duplicate Jobs** is set to **no** and this directive is set to **yes**, Bacula will choose between duplicated jobs the one with the highest level. For example, it will cancel a previous Incremental to run a Full backup. It works only for Backup jobs. The default is **no**. If the levels of the duplicated jobs are the same, nothing is done and the other Cancel XXX Duplicate directives will be examined.

Cancel Queued Duplicates = `<yes|no>` If **Allow Duplicate Jobs** is set to **no** and if this directive is set to **yes** any job that is already queued to run but not yet running will be canceled. The default is **no**.

Cancel Running Duplicates = `<yes|no>` If **Allow Duplicate Jobs** is set to **no** and if this directive is set to **yes** any job that is already running will be canceled. The default is **no**.

Run = `<job-name>` The Run directive (not to be confused with the Run option in a Schedule) allows you to start other jobs or to clone jobs. By using the cloning keywords (see below), you can backup the same data (or almost the same data) to two or more drives at the same time. The **job-name** is normally the same name as the current Job resource (thus creating a clone). However, it may be any Job name, so one job may start other related jobs.

The part after the equal sign must be enclosed in double quotes, and can contain any string or set of options (overrides) that you can specify when entering the Run command from the console. For example **storage=DDS-4 ...**. In addition, there are two special keywords that permit you to clone the current job. They are **level=%l** and **since=%s**. The %l in the level keyword permits entering the actual level of the current job and the %s in the since keyword permits putting the same time for comparison as used on the current job. Note, in the case of the since keyword, the %s must be enclosed in double quotes, and thus they must be preceded by a backslash since they are already inside quotes. For example:

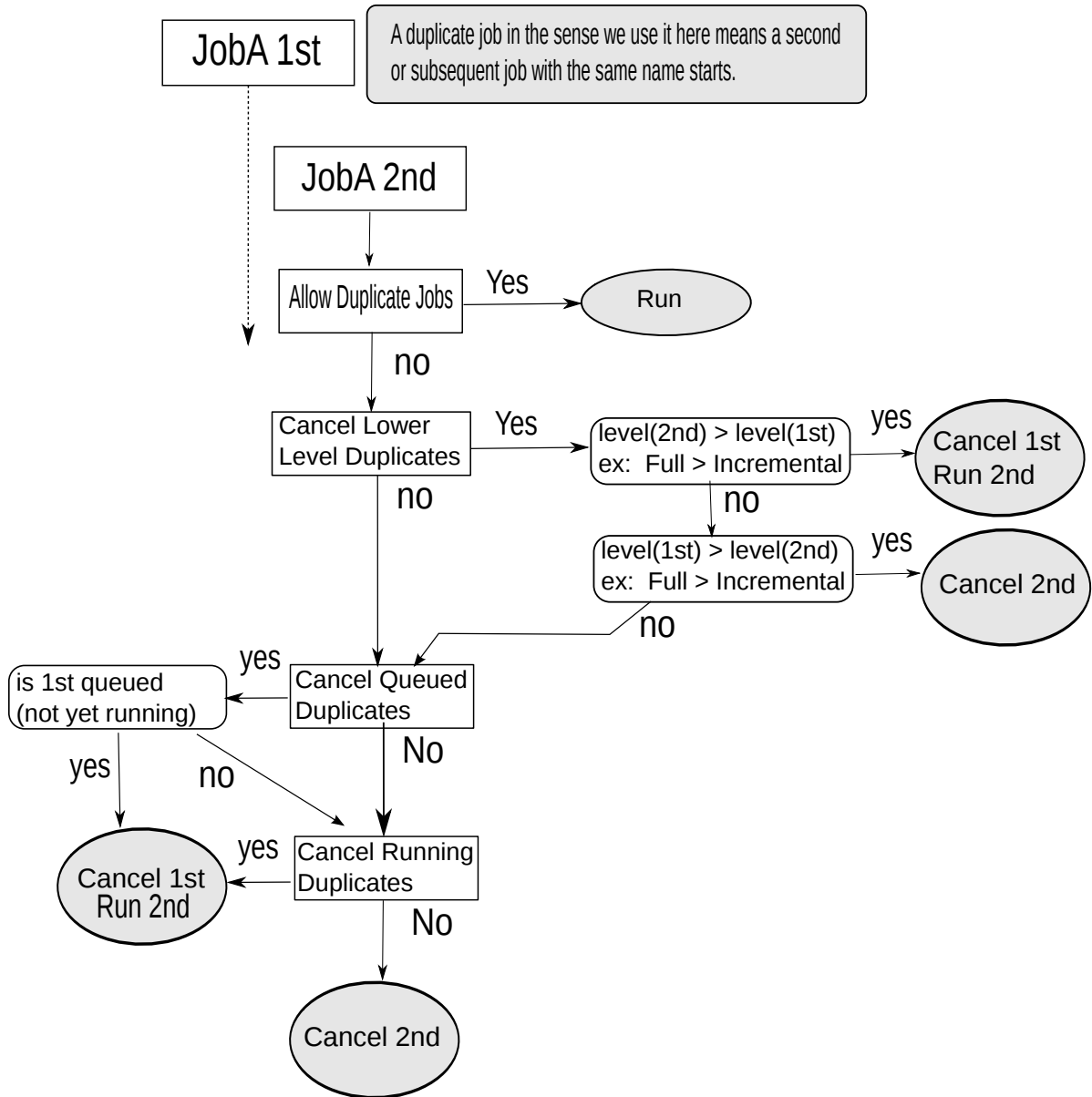

Figure 14.2: Allow Duplicate Jobs usage

```
run = "Nightly-backup level=%l since=\"%s\" storage=DDS-4"
```

A cloned job will not start additional clones, so it is not possible to recurse.

Please note that all cloned jobs, as specified in the Run directives are submitted for running before the original job is run (while it is being initialized). This means that any clone job will actually start before the original job, and may even block the original job from starting until the original job finishes unless you allow multiple simultaneous jobs. Even if you set a lower priority on the clone job, if no other jobs are running, it will start before the original job.

If you are trying to prioritize jobs by using the clone feature (Run directive), you will find it much easier to do using a RunScript resource, or a RunBeforeJob directive.

Priority = <number> This directive permits you to control the order in which your jobs will be run by specifying a positive non-zero number. The higher the number, the lower the job priority. Assuming you are not running concurrent jobs, all queued jobs of priority 1 will run before queued jobs of priority 2 and so on, regardless of the original scheduling order.

The priority only affects waiting jobs that are queued to run, not jobs that are already running. If one or more jobs of priority 2 are already running, and a new job is scheduled with priority 1, the currently running priority 2 jobs must complete before the priority 1 job is run, unless Allow Mixed Priority is set.

The default priority is 10.

If you want to run concurrent jobs you should keep these points in mind:

- See **Running Concurrent Jobs** section (section 2.17 on page 28) on how to setup concurrent jobs in the Bacula Community Problem Resolution Guide.
- Bacula concurrently runs jobs of only one priority at a time. It will not simultaneously run a priority 1 and a priority 2 job.
- If Bacula is running a priority 2 job and a new priority 1 job is scheduled, it will wait until the running priority 2 job terminates even if the Maximum Concurrent Jobs settings would otherwise allow two jobs to run simultaneously.
- Suppose that bacula is running a priority 2 job and a new priority 1 job is scheduled and queued waiting for the running priority 2 job to terminate. If you then start a second priority 2 job, the waiting priority 1 job will prevent the new priority 2 job from running concurrently with the running priority 2 job. That is: as long as there is a higher priority job waiting to run, no new lower priority jobs will start even if the Maximum Concurrent Jobs settings would normally allow them to run. This ensures that higher priority jobs will be run as soon as possible.

If you have several jobs of different priority, it may not best to start them at exactly the same time, because Bacula must examine them one at a time. If by Bacula starts a lower priority job first, then it will run before your high priority jobs. If you experience this problem, you may avoid it by starting any higher priority jobs a few seconds before lower priority ones. This insures that Bacula will examine the jobs in the correct order, and that your priority scheme will be respected.

Allow Mixed Priority = <yes|no> This directive is only implemented in version 2.5 and later. When set to **yes** (default **no**), this job may run even if lower priority jobs are already running. This means a high priority job will not have to wait for other jobs to finish before starting. The scheduler will only mix priorities when all running jobs have this set to true.

Note that only higher priority jobs will start early. Suppose the director will allow two concurrent jobs, and that two jobs with priority 10 are running, with two more in the queue. If a job with priority 5 is added to the queue, it will be run as soon as one of the running jobs finishes. However, new priority 10 jobs will not be run until the priority 5 job has finished.

The following is an example of a valid Job resource definition:

```
Job {
  Name = "Minou"
  Type = Backup
  Level = Incremental           # default
  Client = Minou
  FileSet="Minou Full Set"
  Storage = DLTDive
```



```
Pool = Default
Schedule = "MinouWeeklyCycle"
Messages = Standard
}
```

14.4 The JobDefs Resource

The JobDefs resource permits all the same directives that can appear in a Job resource. However, a JobDefs resource does not create a Job, rather it can be referenced within a Job to provide defaults for that Job. This permits you to concisely define several nearly identical Jobs, each one referencing a JobDefs resource which contains the defaults. Only the changes from the defaults need to be mentioned in each Job.

14.5 The Schedule Resource

The Schedule resource provides a means of automatically scheduling a Job as well as the ability to override the default Level, Pool, Storage and Messages resources. If a Schedule resource is not referenced in a Job, the Job can only be run manually. In general, you specify an action to be taken and when.

Schedule Start of the Schedule directives. No **Schedule** resource is required, but you will need at least one if you want Jobs to be automatically started.

Name = <name> The name of the schedule being defined. The Name directive is required.

Run = <Job-overrides> <Date-time-specification> The Run directive defines when a Job is to be run, and what overrides if any to apply. You may specify multiple **run** directives within a **Schedule** resource. If you do, they will all be applied (i.e. multiple schedules). If you have two **Run** directives that start at the same time, two Jobs will start at the same time (well, within one second of each other).

The **Job-overrides** permit overriding the Level, the Storage, the Messages, and the Pool specifications provided in the Job resource. In addition, the FullPool, the IncrementalPool, and the DifferentialPool specifications permit overriding the Pool specification according to what backup Job Level is in effect.

By the use of overrides, you may customize a particular Job. For example, you may specify a Messages override for your Incremental backups that outputs messages to a log file, but for your weekly or monthly Full backups, you may send the output by email by using a different Messages override.

Job-overrides are specified as: **keyword=value** where the keyword is Level, Storage, Messages, Pool, FullPool, DifferentialPool, or IncrementalPool, and the **value** is as defined on the respective directive formats for the Job resource. You may specify multiple **Job-overrides** on one **Run** directive by separating them with one or more spaces or by separating them with a trailing comma. For example:

Level=Full is all files in the FileSet whether or not they have changed.

Level=Incremental is all files that have changed since the last backup.

Pool=Weekly specifies to use the Pool named **Weekly**.

Storage=DLT_Drive specifies to use **DLT_Drive** for the storage device.

Messages=Verbose specifies to use the **Verbose** message resource for the Job.

FullPool=Full specifies to use the Pool named **Full** if the job is a full backup, or is upgraded from another type to a full backup.

DifferentialPool=Differential specifies to use the Pool named **Differential** if the job is a differential backup.

IncrementalPool=Incremental specifies to use the Pool named **Incremental** if the job is an incremental backup.

Accurate=yes|no tells Bacula to use or not the Accurate code for the specific job. It can allow you to save memory and CPU resources on the catalog server in some cases.

Date-time-specification determines when the Job is to be run. The specification is a repetition, and as a default Bacula is set to run a job at the beginning of the hour of every day of every week of every month of every year. This is not normally what you want, so you must specify or limit when you want the job to run. Any specification given is assumed to be repetitive in nature and



will serve to override or limit the default repetition. This is done by specifying masks or times for the hour, day of the month, day of the week, week of the month, week of the year, and month when you want the job to run. By specifying one or more of the above, you can define a schedule to repeat at almost any frequency you want.

Basically, you must supply a **month**, **day**, **hour**, and **minute** the Job is to be run. Of these four items to be specified, **day** is special in that you may either specify a day of the month such as 1, 2, ... 31, or you may specify a day of the week such as Monday, Tuesday, ... Sunday. Finally, you may also specify a week qualifier to restrict the schedule to the first, second, third, fourth, or fifth week of the month.

For example, if you specify only a day of the week, such as **Tuesday** the Job will be run every hour of every Tuesday of every Month. That is the **month** and **hour** remain set to the defaults of every month and all hours.

Note, by default with no other specification, your job will run at the beginning of every hour. If you wish your job to run more than once in any given hour, you will need to specify multiple **run** specifications each with a different minute.

The date/time to run the Job can be specified in the following way in pseudo-BNF:

```

<void-keyword>    = on
<at-keyword>     = at
<week-keyword>   = 1st | 2nd | 3rd | 4th | 5th | first |
                  second | third | fourth | fifth
<wday-keyword>   = sun | mon | tue | wed | thu | fri | sat |
                  sunday | monday | tuesday | wednesday |
                  thursday | friday | saturday
<week-of-year-keyword> = w00 | w01 | ... w52 | w53
<month-keyword>  = jan | feb | mar | apr | may | jun | jul |
                  aug | sep | oct | nov | dec | january |
                  february | ... | december
<daily-keyword>  = daily
<weekly-keyword> = weekly
<monthly-keyword> = monthly
<hourly-keyword> = hourly
<digit>          = 1 | 2 | 3 | 4 | 5 | 6 | 7 | 8 | 9 | 0
<number>         = <digit> | <digit><number>
<12hour>         = 0 | 1 | 2 | ... 12
<hour>           = 0 | 1 | 2 | ... 23
<minute>         = 0 | 1 | 2 | ... 59
<day>            = 1 | 2 | ... 31
<time>           = <hour>:<minute> |
                  <12hour>:<minute>am |
                  <12hour>:<minute>pm
<time-spec>      = <at-keyword> <time> |
                  <hourly-keyword>
<date-keyword>   = <void-keyword> <weekly-keyword>
<day-range>      = <day>-<day>
<month-range>    = <month-keyword>-<month-keyword>
<wday-range>     = <wday-keyword>-<wday-keyword>
<range>          = <day-range> | <month-range> |
                  <wday-range>
<date>           = <date-keyword> | <day> | <range>
<date-spec>      = <date> | <date-spec>
<day-spec>       = <day> | <wday-keyword> |
                  <day> | <wday-range> |
                  <week-keyword> <wday-keyword> |
                  <week-keyword> <wday-range> |
                  <daily-keyword>
<month-spec>     = <month-keyword> | <month-range> |
                  <monthly-keyword>
<date-time-spec> = <month-spec> <day-spec> <time-spec>

```

Note, the Week of Year specification wnn follows the ISO standard definition of the week of the year, where Week 1 is the week in which the first Thursday of the year occurs, or alternatively, the week which contains the 4th of January. Weeks are numbered w01 to w53. w00 for Bacula is the week that precedes the first ISO week (i.e. has the first few days of the year if any occur before Thursday). w00 is not defined by the ISO specification. A week starts with Monday and ends with Sunday.

According to the NIST (US National Institute of Standards and Technology), 12am and 12pm are ambiguous and can be defined to anything. However, 12:01am is the same as 00:01 and 12:01pm is the same as 12:01, so



Bacula defines 12am as 00:00 (midnight) and 12pm as 12:00 (noon). You can avoid this ambiguity (confusion) by using 24 hour time specifications (i.e. no am/pm). This is the definition in Bacula version 2.0.3 and later. An example schedule resource that is named **WeeklyCycle** and runs a job with level full each Sunday at 2:05am and an incremental job Monday through Saturday at 2:05am is:

```
Schedule {
  Name = "WeeklyCycle"
  Run = Level=Full sun at 2:05
  Run = Level=Incremental mon-sat at 2:05
}
```

An example of a possible monthly cycle is as follows:

```
Schedule {
  Name = "MonthlyCycle"
  Run = Level=Full Pool=Monthly 1st sun at 2:05
  Run = Level=Differential 2nd-5th sun at 2:05
  Run = Level=Incremental Pool=Daily mon-sat at 2:05
}
```

The first of every month:

```
Schedule {
  Name = "First"
  Run = Level=Full on 1 at 2:05
  Run = Level=Incremental on 2-31 at 2:05
}
```

Every 10 minutes:

```
Schedule {
  Name = "TenMinutes"
  Run = Level=Full hourly at 0:05
  Run = Level=Full hourly at 0:15
  Run = Level=Full hourly at 0:25
  Run = Level=Full hourly at 0:35
  Run = Level=Full hourly at 0:45
  Run = Level=Full hourly at 0:55
}
```

14.6 Technical Notes on Schedules

Internally Bacula keeps a schedule as a bit mask. There are six masks and a minute field to each schedule. The masks are hour, day of the month (mday), month, day of the week (wday), week of the month (wom), and week of the year (woy). The schedule is initialized to have the bits of each of these masks set, which means that at the beginning of every hour, the job will run. When you specify a month for the first time, the mask will be cleared and the bit corresponding to your selected month will be selected. If you specify a second month, the bit corresponding to it will also be added to the mask. Thus when Bacula checks the masks to see if the bits are set corresponding to the current time, your job will run only in the two months you have set. Likewise, if you set a time (hour), the hour mask will be cleared, and the hour you specify will be set in the bit mask and the minutes will be stored in the minute field.

For any schedule you have defined, you can see how these bits are set by doing a **show schedules** command in the Console program. Please note that the bit mask is zero based, and Sunday is the first day of the week (bit zero).

-

14.7 The FileSet Resource

The FileSet resource defines what files are to be included or excluded in a backup job. A **FileSet** resource is required for each backup Job. It consists of a list of files or directories to be included, a list of files or directories to be excluded and the various backup options such as compression, encryption, and signatures that are to be applied to each file.

Any change to the list of the included files will cause Bacula to automatically create a new FileSet (defined by the name and an MD5 checksum of the Include/Exclude contents). Each time a new FileSet is created, Bacula will ensure that the next backup is always a Full save.



Bacula is designed to handle most character sets of the world, US ASCII, German, French, Chinese, ... However, it does this by encoding everything in UTF-8, and it expects all configuration files (including those read on Win32 machines) to be in UTF-8 format. UTF-8 is typically the default on Linux machines, but not on all Unix machines, nor on Windows, so you must take some care to ensure that your locale is set properly before starting Bacula. On most modern Win32 machines, you can edit the conf files with **notebook** and choose output encoding UTF-8.

To ensure that Bacula configuration files can be correctly read including foreign characters the **LANG** environment variable must end in **.UTF-8**. A full example is **en_US.UTF-8**. The exact syntax may vary a bit from OS to OS, and exactly how you define it will also vary.

Bacula assumes that all filenames are in UTF-8 format on Linux and Unix machines. On Win32 they are in Unicode (UTF-16), and will be automatically converted to UTF-8 format.

FileSet Start of the FileSet resource. One **FileSet** resource must be defined for each Backup job.

Name = `<name>` The name of the FileSet resource. This directive is required.

Ignore FileSet Changes = `<yes|no>` Normally, if you modify the FileSet Include or Exclude lists, the next backup will be forced to a Full so that Bacula can guarantee that any additions or deletions are properly saved.

We strongly recommend against setting this directive to **yes**, since doing so may cause you to have an incomplete set of backups.

If this directive is set to **yes**, any changes you make to the FileSet Include or Exclude lists, will not force a Full during subsequent backups.

The default is **no**, in which case, if you change the Include or Exclude, Bacula will force a Full backup to ensure that everything is properly backed up.

Enable VSS = `<yes|no>` If this directive is set to **yes** the File daemon will be notified that the user wants to use a Volume Shadow Copy Service (VSS) backup for this job. The default is **yes**. This directive is effective only for VSS enabled Win32 File daemons. It permits a consistent copy of open files to be made for cooperating writer applications, and for applications that are not VSS aware, Bacula can at least copy open files. The Volume Shadow Copy will only be done on Windows drives where the drive (e.g. C:, D:, ...) is explicitly mentioned in a **File** directive. For more information, please see the Windows chapter of this manual.

Include { **Options** {`<file-options>`} ...; `<file-list>` }

Exclude { `<file-list>` }

The Include resource must contain a list of directories and/or files to be processed in the backup job. Normally, all files found in all subdirectories of any directory in the Include File list will be backed up. Note, see below for the definition of `<file-list>`. The Include resource may also contain one or more Options resources that specify options such as compression to be applied to all or any subset of the files found when processing the file-list for backup. Please see below for more details concerning Options resources.

There can be any number of **Include** resources within the FileSet, each having its own list of directories or files to be backed up and the backup options defined by one or more Options resources. The **file-list** consists of one file or directory name per line. Directory names should be specified without a trailing slash with Unix path notation.

Windows users, please take note to specify directories (even `c:/...`) in Unix path notation. If you use Windows conventions, you will most likely not be able to restore your files due to the fact that the Windows path separator was defined as an escape character long before Windows existed, and Bacula adheres to that convention (i.e.

means the next character appears as itself).

You should always specify a full path for every directory and file that you list in the FileSet. In addition, on Windows machines, you should **always** prefix the directory or filename with the drive specification (e.g. **c:/xxx**) using Unix directory name separators (forward slash). The drive letter itself can be upper or lower case (e.g. `c:/xxx` or `C:/xxx`).

Bacula's default for processing directories is to recursively descend in the directory saving all files and subdirectories. Bacula will not by default cross filesystems (or mount points in Unix parlance). This means that if you specify the root partition (e.g. `/`), Bacula will save only the root partition and not any of the other mounted filesystems. Similarly on Windows systems, you must explicitly specify each of the drives you want saved (e.g. `c:/` and `d:/` ...). In addition, at least for Windows systems, you will most likely want to



enclose each specification within double quotes particularly if the directory (or file) name contains spaces. The **df** command on Unix systems will show you which mount points you must specify to save everything. See below for an example.

Take special care not to include a directory twice or Bacula will backup the same files two times wasting a lot of space on your archive device. Including a directory twice is very easy to do. For example:

```
Include {
  Options { compression=GZIP }
  File = /
  File = /usr
}
```

on a Unix system where `/usr` is a subdirectory (rather than a mounted filesystem) will cause `/usr` to be backed up twice.

Please take note of the following items in the FileSet syntax:

1. There is no equal sign (=) after the Include and before the opening brace ({}). The same is true for the Exclude.
2. Each directory (or filename) to be included or excluded is preceded by a **File =**. Previously they were simply listed on separate lines.
3. The options that previously appeared on the Include line now must be specified within their own Options resource.
4. The Exclude resource does not accept Options.
5. When using wild-cards or regular expressions, directory names are always terminated with a slash (/) and filenames have no trailing slash.

The Options resource is optional, but when specified, it will contain a list of **keyword=value** options to be applied to the file-list. See below for the definition of file-list. Multiple Options resources may be specified one after another. As the files are found in the specified directories, the Options will applied to the filenames to determine if and how the file should be backed up. The wildcard and regular expression pattern matching parts of the Options resources are checked in the order they are specified in the FileSet until the first one that matches. Once one matches, the compression and other flags within the Options specification will apply to the pattern matched.

A key point is that in the absence of an Option or no other Option is matched, every file is accepted for backing up. This means that if you want to exclude something, you must explicitly specify an Option with an **exclude = yes** and some pattern matching.

Once Bacula determines that the Options resource matches the file under consideration, that file will be saved without looking at any other Options resources that may be present. This means that any wild cards must appear before an Options resource without wild cards.

If for some reason, Bacula checks all the Options resources to a file under consideration for backup, but there are no matches (generally because of wild cards that don't match), Bacula as a default will then backup the file. This is quite logical if you consider the case of no Options clause is specified, where you want everything to be backed up, and it is important to keep in mind when excluding as mentioned above.

However, one additional point is that in the case that no match was found, Bacula will use the options found in the last Options resource. As a consequence, if you want a particular set of "default" options, you should put them in an Options resource after any other Options.

It is a good idea to put all your wild-card and regex expressions inside double quotes to prevent conf file scanning problems.

This is perhaps a bit overwhelming, so there are a number of examples included below to illustrate how this works.

You find yourself using a lot of Regex statements, which will cost quite a lot of CPU time, we recommend you simplify them if you can, or better yet convert them to Wild statements which are much more efficient. The directives within an Options resource may be one of the following:

compression=GZIP All files saved will be software compressed using the GNU ZIP compression format.

The compression is done on a file by file basis by the File daemon. If there is a problem reading the tape in a single record of a file, it will at most affect that file and none of the other files on the tape. Normally this option is **not** needed if you have a modern tape drive as the drive will do its own compression. In fact, if you specify software compression at the same time you have hardware compression turned on, your files may actually take more space on the volume.



Software compression is very important if you are writing your Volumes to a file, and it can also be helpful if you have a fast computer but a slow network, otherwise it is generally better to rely your tape drive's hardware compression. As noted above, it is not generally a good idea to do both software and hardware compression.

Specifying **GZIP** uses the default compression level 6 (i.e. **GZIP** is identical to **GZIP6**). If you want a different compression level (1 through 9), you can specify it by appending the level number with no intervening spaces to **GZIP**. Thus **compression=GZIP1** would give minimum compression but the fastest algorithm, and **compression=GZIP9** would give the highest level of compression, but requires more computation. According to the GZIP documentation, compression levels greater than six generally give very little extra compression and are rather CPU intensive.

You can overwrite this option per Storage resource with AllowCompression option.

compression=LZO All files saved will be software compressed using the LZO compression format. The compression is done on a file by file basis by the File daemon. Everything else about GZIP is true for LZO.

LZO provides much faster compression and decompression speed but lower compression ratio than GZIP. If your CPU is fast enough you should be able to compress your data without making the backup duration longer.

Note that bacula only use one compression level LZO1X-1 specified by LZO.

You can overwrite this option per Storage resource with AllowCompression option.

signature=SHA1 An SHA1 signature will be computed for all The SHA1 algorithm is purported to be some what slower than the MD5 algorithm, but at the same time is significantly better from a cryptographic point of view (i.e. much fewer collisions, much lower probability of being hacked.) It adds four more bytes than the MD5 signature. We strongly recommend that either this option or MD5 be specified as a default for all files. Note, only one of the two options MD5 or SHA1 can be computed for any file.

signature=MD5 An MD5 signature will be computed for all files saved. Adding this option generates about 5% extra overhead for each file saved. In addition to the additional CPU time, the MD5 signature adds 16 more bytes per file to your catalog. We strongly recommend that this option or the SHA1 option be specified as a default for all files.

basejob=<options> The options letters specified are used when running a **Backup Level=Full** with BaseJobs. The options letters are the same as in the **verify=** options below.

accurate=<options> The options letters specified are used when running a **Backup Level=Incremental/Differential** in Accurate mode. The options letters are the same as in the **verify=** directive below.

verify=<options> The options letters specified are used when running a **Verify Level=Catalog** as well as the **DiskToCatalog** level job. The options letters may be any combination of the following:

- i** compare the inodes
- p** compare the permission bits
- n** compare the number of links
- u** compare the user id
- g** compare the group id
- s** compare the size
- a** compare the access time
- m** compare the modification time (st_mtime)
- c** compare the change time (st_ctime)
- d** report file size decreases
- 5** compare the MD5 signature
- 1** compare the SHA1 signature
- A** Only for Accurate option, it allows to always backup the file

A useful set of general options on the **Level=Catalog** or **Level=DiskToCatalog** verify is **pins5** i.e. compare permission bits, inodes, number of links, size, and MD5 changes.



onefs=yes|no If set to **yes** (the default), **Bacula** will remain on a single file system. That is it will not backup file systems that are mounted on a subdirectory. If you are using a *nix system, you may not even be aware that there are several different filesystems as they are often automatically mounted by the OS (e.g. /dev, /net, /sys, /proc, ...). Bacula will inform you when it decides not to traverse into another filesystem. This can be very useful if you forgot to backup a particular partition. An example of the informational message in the job report is:

```
rufus-fd: /misc is a different filesystem. Will not descend from / into /misc
rufus-fd: /net is a different filesystem. Will not descend from / into /net
rufus-fd: /var/lib/nfs/rpc_pipefs is a different filesystem. Will not descend from /var/lib/nfs into /var/lib/nfs/rpc_
rufus-fd: /selinux is a different filesystem. Will not descend from / into /selinux
rufus-fd: /sys is a different filesystem. Will not descend from / into /sys
rufus-fd: /dev is a different filesystem. Will not descend from / into /dev
rufus-fd: /home is a different filesystem. Will not descend from / into /home
```

Note: in older versions of Bacula, the above message was of the form:

```
Filesystem change prohibited. Will not descend into /misc
```

If you wish to backup multiple filesystems, you can explicitly list each filesystem you want saved. Otherwise, if you set the **onefs** option to **no**, Bacula will backup all mounted file systems (i.e. traverse mount points) that are found within the **FileSet**. Thus if you have NFS or Samba file systems mounted on a directory listed in your FileSet, they will also be backed up. Normally, it is preferable to set **onefs=yes** and to explicitly name each filesystem you want backed up. Explicitly naming the filesystems you want backed up avoids the possibility of getting into a infinite loop recursing filesystems. Another possibility is to use **onefs=no** and to set **fstype=ext2, ...**. See the example below for more details.

If you think that Bacula should be backing up a particular directory and it is not, and you have **onefs=no** set, before you complain, please do:

```
stat /
stat <filesystem>
```

where you replace **filesystem** with the one in question. If the **Device:** number is different for / and for your filesystem, then they are on different filesystems. E.g.

```
stat /
  File: '/'
  Size: 4096          Blocks: 16          IO Block: 4096  directory
Device: 302h/770d   Inode: 2           Links: 26
Access: (0755/drwxr-xr-x)  Uid: (  0/   root)   Gid: (  0/   root)
Access: 2005-11-10 12:28:01.000000000 +0100
Modify: 2005-09-27 17:52:32.000000000 +0200
Change: 2005-09-27 17:52:32.000000000 +0200

stat /net
  File: '/home'
  Size: 4096          Blocks: 16          IO Block: 4096  directory
Device: 308h/776d   Inode: 2           Links: 7
Access: (0755/drwxr-xr-x)  Uid: (  0/   root)   Gid: (  0/   root)
Access: 2005-11-10 12:28:02.000000000 +0100
Modify: 2005-11-06 12:36:48.000000000 +0100
Change: 2005-11-06 12:36:48.000000000 +0100
```

Also be aware that even if you include **/home** in your list of files to backup, as you most likely should, you will get the informational message that “/home is a different filesystem” when Bacula is processing the / directory. This message does not indicate an error. This message means that while examining the **File =** referred to in the second part of the message, Bacula will not descend into the directory mentioned in the first part of the message. However, it is possible that the separate filesystem will be backed up despite the message. For example, consider the following FileSet:

```
File = /
File = /var
```



where **/var** is a separate filesystem. In this example, you will get a message saying that Bacula will not descend from **/** into **/var**. But it is important to realise that Bacula will descend into **/var** from the second File directive shown above. In effect, the warning is bogus, but it is supplied to alert you to possible omissions from your FileSet. In this example, **/var** will be backed up. If you changed the FileSet such that it did not specify **/var**, then **/var** will not be backed up.

honor nodump flag=<yes|no> If your file system supports the **nodump** flag (e. g. most BSD-derived systems) Bacula will honor the setting of the flag when this option is set to **yes**. Files having this flag set will not be included in the backup and will not show up in the catalog. For directories with the **nodump** flag set recursion is turned off and the directory will be listed in the catalog. If the **honor nodump flag** option is not defined or set to **no** every file and directory will be eligible for backup.

portable=yes|no If set to **yes** (default is **no**), the Bacula File daemon will backup Win32 files in a portable format, but not all Win32 file attributes will be saved and restored. By default, this option is set to **no**, which means that on Win32 systems, the data will be backed up using Windows BackupRead API calls and all the security and ownership attributes will be properly backed up (and restored). However this format is not portable to other systems – e.g. Unix, and very old Win95/98/Me systems. When backing up Unix systems, this option is ignored, and unless you have a specific need to have portable backups, we recommend accept the default (**no**) so that the maximum information concerning your Windows files is saved.

recurse=yes|no If set to **yes** (the default), Bacula will recurse (or descend) into all subdirectories found unless the directory is explicitly excluded using an **exclude** definition. If you set **recurse=no**, Bacula will save the subdirectory entries, but not descend into the subdirectories, and thus will not save the files or directories contained in the subdirectories. Normally, you will want the default (**yes**).

sparse=yes|no Enable special code that checks for sparse files such as created by ndbm. The default is **no**, so no checks are made for sparse files. You may specify **sparse=yes** even on files that are not sparse file. No harm will be done, but there will be a small additional overhead to check for buffers of all zero, and if there is a 32K block of all zeros (see below), that block will become a hole in the file, which may not be desirable if the original file was not a sparse file.

Restrictions: Bacula reads files in 32K buffers. If the whole buffer is zero, it will be treated as a sparse block and not written to tape. However, if any part of the buffer is non-zero, the whole buffer will be written to tape, possibly including some disk sectors (generally 4098 bytes) that are all zero. As a consequence, Bacula's detection of sparse blocks is in 32K increments rather than the system block size. If anyone considers this to be a real problem, please send in a request for change with the reason.

If you are not familiar with sparse files, an example is say a file where you wrote 512 bytes at address zero, then 512 bytes at address 1 million. The operating system will allocate only two blocks, and the empty space or hole will have nothing allocated. However, when you read the sparse file and read the addresses where nothing was written, the OS will return all zeros as if the space were allocated, and if you backup such a file, a lot of space will be used to write zeros to the volume. Worse yet, when you restore the file, all the previously empty space will now be allocated using much more disk space. By turning on the **sparse** option, Bacula will specifically look for empty space in the file, and any empty space will not be written to the Volume, nor will it be restored. The price to pay for this is that Bacula must search each block it reads before writing it. On a slow system, this may be important. If you suspect you have sparse files, you should benchmark the difference or set sparse for only those files that are really sparse.

You probably should not use this option on files or raw disk devices that are not really sparse files (i.e. have holes in them).

readfifo=yes|no If enabled, tells the Client to read the data on a backup and write the data on a restore to any FIFO (pipe) that is explicitly mentioned in the FileSet. In this case, you must have a program already running that writes into the FIFO for a backup or reads from the FIFO on a restore. This can be accomplished with the **RunBeforeJob** directive. If this is not the case, Bacula will hang indefinitely on reading/writing the FIFO. When this is not enabled (default), the Client simply saves the directory entry for the FIFO.

Unfortunately, when Bacula runs a RunBeforeJob, it waits until that script terminates, and if the script accesses the FIFO to write into the it, the Bacula job will block and everything will stall. However, Vladimir Stavrinov as supplied tip that allows this feature to work correctly. He simply adds the following to the beginning of the RunBeforeJob script:



```
exec > /dev/null
```

noatime=yes|no If enabled, and if your Operating System supports the `O_NOATIME` file open flag, Bacula will open all files to be backed up with this option. It makes it possible to read a file without updating the inode `atime` (and also without the inode `ctime` update which happens if you try to set the `atime` back to its previous value). It also prevents a race condition when two programs are reading the same file, but only one does not want to change the `atime`. It's most useful for backup programs and file integrity checkers (and bacula can fit on both categories).

This option is particularly useful for sites where users are sensitive to their MailBox file access time. It replaces both the **keepatime** option without the inconveniences of that option (see below).

If your Operating System does not support this option, it will be silently ignored by Bacula.

mtimeonly=yes|no If enabled, tells the Client that the selection of files during Incremental and Differential backups should be based only on the `st_mtime` value in the `stat()` packet. The default is **no** which means that the selection of files to be backed up will be based on both the `st_mtime` and the `st_ctime` values. In general, it is not recommended to use this option.

keepatime=yes|no The default is **no**. When enabled, Bacula will reset the `st_atime` (access time) field of files that it backs up to their value prior to the backup. This option is not generally recommended as there are very few programs that use `st_atime`, and the backup overhead is increased because of the additional system call necessary to reset the times. However, for some files, such as mailboxes, when Bacula backs up the file, the user will notice that someone (Bacula) has accessed the file. In this case `keepatime` can be useful. (I'm not sure this works on Win32).

Note, if you use this feature, when Bacula resets the access time, the change time (`st_ctime`) will automatically be modified by the system, so on the next incremental job, the file will be backed up even if it has not changed. As a consequence, you will probably also want to use **mtimeonly = yes** as well as `keepatime` (thanks to Rudolf Cejka for this tip).

checkfilechanges=yes|no On versions 2.0.4 or greater, if enabled, the Client will check size, age of each file after their backup to see if they have changed during backup. If time or size mismatch, an error will raise.

```
zog-fd: Client1.2007-03-31_09.46.21 Error: /tmp/test mtime changed during backup.
```

In general, it is recommended to use this option.

hardlinks=yes|no When enabled (default), this directive will cause hard links to be backed up. However, the File daemon keeps track of hard linked files and will backup the data only once. The process of keeping track of the hard links can be quite expensive if you have lots of them (tens of thousands or more). This doesn't occur on normal Unix systems, but if you use a program like BackupPC, it can create hundreds of thousands, or even millions of hard links. Backups become very long and the File daemon will consume a lot of CPU power checking hard links. In such a case, set **hardlinks=no** and hard links will not be backed up. Note, using this option will most likely backup more data and on a restore the file system will not be restored identically to the original.

wild=<string> Specifies a wild-card string to be applied to the filenames and directory names. Note, if **Exclude** is not enabled, the wild-card will select which files are to be included. If **Exclude=yes** is specified, the wild-card will select which files are to be excluded. Multiple wild-card directives may be specified, and they will be applied in turn until the first one that matches. Note, if you exclude a directory, no files or directories below it will be matched.

You may want to test your expressions prior to running your backup by using the `bwild` program. Please see the **Utilities** chapter (chapter 1.14 on page 19) of the Bacula Community Utility programs for more information. You can also test your full FileSet definition by using the **estimate** command (command 1.5 on page 5) in the Bacula Community Console Manual. It is recommended to enclose the string in double quotes.

wilddir=<string> Specifies a wild-card string to be applied to directory names only. No filenames will be matched by this directive. Note, if **Exclude** is not enabled, the wild-card will select directories to be included. If **Exclude=yes** is specified, the wild-card will select which directories are to be excluded. Multiple wild-card directives may be specified, and they will be applied in turn until the first one that matches. Note, if you exclude a directory, no files or directories below it will be matched.



It is recommended to enclose the string in double quotes.

You may want to test your expressions prior to running your backup by using the `bwild` program. Please see the **Utilities** chapter (chapter 1.14 on page 19) of the Bacula Community Utility programs for more information. You can also test your full FileSet definition by using the `estimate` command (command 1.5 on page 5) in the Bacula Community Console Manual. An example of excluding with the `WildDir` option on Win32 machines is presented below.

wildfile=<string> Specifies a wild-card string to be applied to non-directories. That is no directory entries will be matched by this directive. However, note that the match is done against the full path and filename, so your wild-card string must take into account that filenames are preceded by the full path. If **Exclude** is not enabled, the wild-card will select which files are to be included. If **Exclude=yes** is specified, the wild-card will select which files are to be excluded. Multiple wild-card directives may be specified, and they will be applied in turn until the first one that matches.

It is recommended to enclose the string in double quotes.

You may want to test your expressions prior to running your backup by using the `bwild` program. Please see the **Utilities** chapter (chapter 1.14 on page 19) of the Bacula Community Utility programs for more information. You can also test your full FileSet definition by using the `estimate` command (command 1.5 on page 5) in the Bacula Community Console Manual. An example of excluding with the `WildFile` option on Win32 machines is presented below.

regex=<string> Specifies a POSIX extended regular expression to be applied to the filenames and directory names, which include the full path. If **Exclude** is not enabled, the regex will select which files are to be included. If **Exclude=yes** is specified, the regex will select which files are to be excluded. Multiple regex directives may be specified within an Options resource, and they will be applied in turn until the first one that matches. Note, if you exclude a directory, no files or directories below it will be matched.

It is recommended to enclose the string in double quotes.

The regex libraries differ from one operating system to another, and in addition, regular expressions are complicated, so you may want to test your expressions prior to running your backup by using the `bregex` program. Please see the **Utilities** chapter (chapter 1.14 on page 19) of the Bacula Community Utility programs for more information. You can also test your full FileSet definition by using the `estimate` command (command 1.5 on page 5) in the Bacula Community Console Manual.

You find yourself using a lot of Regex statements, which will cost quite a lot of CPU time, we recommend you simplify them if you can, or better yet convert them to Wild statements which are much more efficient.

regexfile=<string> Specifies a POSIX extended regular expression to be applied to non-directories. No directories will be matched by this directive. However, note that the match is done against the full path and filename, so your regex string must take into account that filenames are preceded by the full path. If **Exclude** is not enabled, the regex will select which files are to be included. If **Exclude=yes** is specified, the regex will select which files are to be excluded. Multiple regex directives may be specified, and they will be applied in turn until the first one that matches.

It is recommended to enclose the string in double quotes.

The regex libraries differ from one operating system to another, and in addition, regular expressions are complicated, so you may want to test your expressions prior to running your backup by using the `bregex` program. Please see the `bregex` command (command 1.13 on page 19) of the Bacula Community Utility programs more.

regexdir=<string> Specifies a POSIX extended regular expression to be applied to directory names only. No filenames will be matched by this directive. Note, if **Exclude** is not enabled, the regex will select directories files are to be included. If **Exclude=yes** is specified, the regex will select which files are to be excluded. Multiple regex directives may be specified, and they will be applied in turn until the first one that matches. Note, if you exclude a directory, no files or directories below it will be matched.

It is recommended to enclose the string in double quotes.

The regex libraries differ from one operating system to another, and in addition, regular expressions are complicated, so you may want to test your expressions prior to running your backup by using the `bregex` program. Please see the `bregex` command (command 1.13 on page 19) of the Bacula Community Utility programs more.



exclude=yes|no The default is **no**. When enabled, any files matched within the Options will be excluded from the backup.

aclsupport=yes|no The default is **no**. If this option is set to yes, and you have the POSIX **libacl** installed on your Linux system, Bacula will backup the file and directory Unix Access Control Lists (ACL) as defined in IEEE Std 1003.1e draft 17 and “POSIX.1e” (abandoned). This feature is available on Unix systems only and requires the Linux ACL library. Bacula is automatically compiled with ACL support if the **libacl** library is installed on your Linux system (shown in config.out). While restoring the files Bacula will try to restore the ACLs, if there is no ACL support available on the system, Bacula restores the files and directories but not the ACL information. Please note, if you backup an EXT3 or XFS filesystem with ACLs, then you restore them to a different filesystem (perhaps reiserfs) that does not have ACLs, the ACLs will be ignored.

For other operating systems there is support for either POSIX ACLs or the more extensible NFSv4 ACLs.

The ACL stream format between Operation Systems is **not** compatible so for example an ACL saved on Linux cannot be restored on Solaris.

The following Operating Systems are currently supported:

1. AIX (pre-5.3 (POSIX) and post 5.3 (POSIX and NFSv4) ACLs)
2. Darwin
3. FreeBSD (POSIX and NFSv4/ZFS ACLs)
4. HPUX
5. IRIX
6. Linux
7. Solaris (POSIX and NFSv4/ZFS ACLs)
8. Tru64

xattrsupport=yes|no The default is **no**. If this option is set to yes, and your operating system support either so called Extended Attributes or Extensible Attributes Bacula will backup the file and directory XATTR data. This feature is available on UNIX only and depends on support of some specific library calls in libc.

The XATTR stream format between Operating Systems is **not** compatible so an XATTR saved on Linux cannot for example be restored on Solaris.

On some operating systems ACLs are also stored as Extended Attributes (Linux, Darwin, FreeBSD) Bacula checks if you have the **aclsupport** option enabled and if so will not save the same info when saving extended attribute information. Thus ACLs are only saved once.

The following Operating Systems are currently supported:

1. AIX (Extended Attributes)
2. Darwin (Extended Attributes)
3. FreeBSD (Extended Attributes)
4. IRIX (Extended Attributes)
5. Linux (Extended Attributes)
6. NetBSD (Extended Attributes)
7. Solaris (Extended Attributes and Extensible Attributes)
8. Tru64 (Extended Attributes)

ignore case=yes|no The default is **no**. On Windows systems, you will almost surely want to set this to **yes**. When this directive is set to **yes** all the case of character will be ignored in wild-card and regex comparisons. That is an uppercase A will match a lowercase a.

fstype=filesystem-type This option allows you to select files and directories by the filesystem type. The permitted filesystem-type names are:

ext2, jfs, ntfs, proc, reiserfs, xfs, usbdevfs, sysfs, smbfs, iso9660.



You may have multiple `Fstype` directives, and thus permit matching of multiple filesystem types within a single Options resource. If the type specified on the `fstype` directive does not match the filesystem for a particular directive, that directory will not be backed up. This directive can be used to prevent backing up non-local filesystems. Normally, when you use this directive, you would also set `onefs=no` so that Bacula will traverse filesystems.

DriveType=Windows-drive-type This option is effective only on Windows machines and is somewhat similar to the Unix/Linux `fstype` described above, except that it allows you to select what Windows drive types you want to allow. By default all drive types are accepted.

The permitted drivetype names are:

removable, fixed, remote, cdrom, ramdisk

You may have multiple `Driveype` directives, and thus permit matching of multiple drive types within a single Options resource. If the type specified on the `drivetype` directive does not match the filesystem for a particular directive, that directory will not be backed up. This directive can be used to prevent backing up non-local filesystems. Normally, when you use this directive, you would also set `onefs=no` so that Bacula will traverse filesystems.

This option is not implemented in Unix/Linux systems.

hfsplussupport=yes|no This option allows you to turn on support for Mac OSX HFS plus finder information.

strippath=<integer> This option will cause `integer` paths to be stripped from the front of the full path/filename being backed up. This can be useful if you are migrating data from another vendor or if you have taken a snapshot into some subdirectory. This directive can cause your filenames to be overlaid with regular backup data, so should be used only by experts and with great care.

`<file-list>` is a list of directory and/or filename names specified with a `File =` directive. To include names containing spaces, enclose the name between double-quotes. Wild-cards are not interpreted in file-lists. They can only be specified in Options resources.

There are a number of special cases when specifying directories and files in a `file-list`. They are:

- Any name preceded by an at-sign (@) is assumed to be the name of a file, which contains a list of files each preceded by a "File =". The named file is read once when the configuration file is parsed during the Director startup. Note, that the file is read on the Director's machine and not on the Client's. In fact, the @filename can appear anywhere within the conf file where a token would be read, and the contents of the named file will be logically inserted in the place of the @filename. What must be in the file depends on the location the @filename is specified in the conf file. For example:

```
Include {
  Options { compression=GZIP }
  @/home/files/my-files
}
```

- Any name beginning with a vertical bar (|) is assumed to be the name of a program. This program will be executed on the Director's machine at the time the Job starts (not when the Director reads the configuration file), and any output from that program will be assumed to be a list of files or directories, one per line, to be included. Before submitting the specified command bacula will perform character substitution.

This allows you to have a job that, for example, includes all the local partitions even if you change the partitioning by adding a disk. The examples below show you how to do this. However, please note two things:

1. if you want the local filesystems, you probably should be using the new `fstype` directive, which was added in version 1.36.3 and set `onefs=no`.

2. the exact syntax of the command needed in the examples below is very system dependent. For example, on recent Linux systems, you may need to add the `-P` option, on FreeBSD systems, the options will be different as well.

In general, you will need to prefix your command or commands with a `sh -c` so that they are invoked by a shell. This will not be the case if you are invoking a script as in the second example below. Also, you must take care to escape (precede with a `\`) wild-cards, shell character, and to ensure that any



spaces in your command are escaped as well. If you use a single quotes (') within a double quote ("), Bacula will treat everything between the single quotes as one field so it will not be necessary to escape the spaces. In general, getting all the quotes and escapes correct is a real pain as you can see by the next example. As a consequence, it is often easier to put everything in a file and simply use the file name within Bacula. In that case the **sh -c** will not be necessary providing the first line of the file is **#!/bin/sh**.

As an example:

```
Include {
  Options { signature = SHA1 }
  File = "|sh -c 'df -l | grep \"~/dev/hd[ab]\" | grep -v \".*/tmp\" \
    | awk \"{print \\$6}\"\""
}
```

will produce a list of all the local partitions on a Red Hat Linux system. Note, the above line was split, but should normally be written on one line. Quoting is a real problem because you must quote for Bacula which consists of preceding every \ and every " with a \, and you must also quote for the shell command. In the end, it is probably easier just to execute a small file with:

```
Include {
  Options {
    signature=MD5
  }
  File = "|my_partitions"
}
```

where my_partitions has:

```
#!/bin/sh
df -l | grep "~/dev/hd[ab]" | grep -v ".*/tmp" \
  | awk "{print \$6}"
```

If the vertical bar (|) in front of my_partitions is preceded by a backslash as in \|, the program will be executed on the Client's machine instead of on the Director's machine. Please note that if the filename is given within quotes, you will need to use two slashes. An example, provided by John Donagher, that backs up all the local UFS partitions on a remote system is:

```
FileSet {
  Name = "All local partitions"
  Include {
    Options { signature=SHA1; onefs=yes; }
    File = "\\|bash -c \"df -klF ufs | tail +2 | awk '{print \\$6}'\""
  }
}
```

The above requires two backslash characters after the double quote (one preserves the next one). If you are a Linux user, just change the **ufs** to **ext3** (or your preferred filesystem type), and you will be in business.

If you know what filesystems you have mounted on your system, e.g. for Red Hat Linux normally only ext2 and ext3, you can backup all local filesystems using something like:

```
Include {
  Options { signature = SHA1; onfs=no; fstype=ext2 }
  File = /
}
```

- Any file-list item preceded by a less-than sign (<) will be taken to be a file. This file will be read on the Director's machine (see below for doing it on the Client machine) at the time the Job starts, and the data will be assumed to be a list of directories or files, one per line, to be included. The names should start in column 1 and should not be quoted even if they contain spaces. This feature allows you to modify the external file and change what will be saved without stopping and restarting Bacula as would be necessary if using the @ modifier noted above. For example:



```

Include {
  Options { signature = SHA1 }
  File = "</home/files/local-filelist"
}

```

If you precede the less-than sign (<) with a backslash as in \<, the file-list will be read on the Client machine instead of on the Director's machine. Please note that if the filename is given within quotes, you will need to use two slashes.

```

Include {
  Options { signature = SHA1 }
  File = "\\</home/xxx/filelist-on-client"
}

```

- If you explicitly specify a block device such as `/dev/hda1`, then Bacula (starting with version 1.28) will assume that this is a raw partition to be backed up. In this case, you are strongly urged to specify a `sparse=yes` include option, otherwise, you will save the whole partition rather than just the actual data that the partition contains. For example:

```

Include {
  Options { signature=MD5; sparse=yes }
  File = /dev/hd6
}

```

will backup the data in device `/dev/hd6`. Note, the `bf /dev/hd6` must be the raw partition itself. Bacula will not back it up as a raw device if you specify a symbolic link to a raw device such as my be created by the LVM Snapshot utilities.

Ludovic Strappazon has pointed out that this feature can be used to backup a full Microsoft Windows disk. Simply boot into the system using a Linux Rescue disk, then load a statically linked Bacula as described in the Disaster Recovery Using Bacula chapter of this manual. Then save the whole disk partition. In the case of a disaster, you can then restore the desired partition by again booting with the rescue disk and doing a restore of the partition.

- If you explicitly specify a FIFO device name (created with `mkfifo`), and you add the option `readfifo=yes` as an option, Bacula will read the FIFO and back its data up to the Volume. For example:

```

Include {
  Options {
    signature=SHA1
    readfifo=yes
  }
  File = /home/abc/fifo
}

```

if `/home/abc/fifo` is a fifo device, Bacula will open the fifo, read it, and store all data thus obtained on the Volume. Please note, you must have a process on the system that is writing into the fifo, or Bacula will hang, and after one minute of waiting, Bacula will give up and go on to the next file. The data read can be anything since Bacula treats it as a stream.

This feature can be an excellent way to do a “hot” backup of a very large database. You can use the **RunBeforeJob** to create the fifo and to start a program that dynamically reads your database and writes it to the fifo. Bacula will then write it to the Volume. Be sure to read the `readfifo` section that gives a tip to ensure that the `RunBeforeJob` does not block Bacula.

During the restore operation, the inverse is true, after Bacula creates the fifo if there was any data stored with it (no need to explicitly list it or add any options), that data will be written back to the fifo. As a consequence, if any such FIFOs exist in the fileset to be restored, you must ensure that there is a reader program or Bacula will block, and after one minute, Bacula will time out the write to the fifo and move on to the next file.

- A file-list may not contain wild-cards. Use directives in the Options resource if you wish to specify wild-cards or regular expression matching.
- The **ExcludeDirContaining = <filename>** is a directive that can be added to the Include section of the FileSet resource. If the specified filename (**filename-string**) is found on the Client in any directory to be backed up, the whole directory will be ignored (not backed up). For example:



```
# List of files to be backed up
FileSet {
  Name = "MyFileSet"
  Include {
    Options {
      signature = MD5
    }
    File = /home
    Exclude Dir Containing = .excludeme
  }
}
```

But in /home, there may be hundreds of directories of users and some people want to indicate that they don't want to have certain directories backed up. For example, with the above FileSet, if the user or sysadmin creates a file named **.excludeme** in specific directories, such as

```
/home/user/www/cache/.excludeme
/home/user/temp/.excludeme
```

then Bacula will not backup the two directories named:

```
/home/user/www/cache
/home/user/temp
```

NOTE: subdirectories will not be backed up. That is, the directive applies to the two directories in question and any children (be they files, directories, etc).

14.8 FileSet Examples

The following is an example of a valid FileSet resource definition. Note, the first Include pulls in the contents of the file **/etc/backup.list** when Bacula is started (i.e. the @), and that file must have each filename to be backed up preceded by a **File =** and on a separate line.

```
FileSet {
  Name = "Full Set"
  Include {
    Options {
      Compression=GZIP
      signature=SHA1
      Sparse = yes
    }
    @/etc/backup.list
  }
  Include {
    Options {
      wildfile = "*.o"
      wildfile = "*.exe"
      Exclude = yes
    }
    File = /root/myfile
    File = /usr/lib/another_file
  }
}
```

In the above example, all the files contained in /etc/backup.list will be compressed with GZIP compression, an SHA1 signature will be computed on the file's contents (its data), and sparse file handling will apply. The two directories /root/myfile and /usr/lib/another_file will also be saved without any options, but all files in those directories with the extensions **.o** and **.exe** will be excluded.

Let's say that you now want to exclude the directory /tmp. The simplest way to do so is to add an exclude directive that lists /tmp. The example above would then become:

```
FileSet {
  Name = "Full Set"
  Include {
    Options {
```



```

        Compression=GZIP
        signature=SHA1
        Sparse = yes
    }
    @/etc/backup.list
}
Include {
    Options {
        wildfile = "*.o"
        wildfile = "*.exe"
        Exclude = yes
    }
    File = /root/myfile
    File = /usr/lib/another_file
}
Exclude {
    File = /tmp                # don't add trailing /
}
}

```

You can add wild-cards to the File directives listed in the Exclude directory, but you need to take care because if you exclude a directory, it and all files and directories below it will also be excluded.

Now lets take a slight variation on the above and suppose you want to save all your whole filesystem except **/tmp**. The problem that comes up is that Bacula will not normally cross from one filesystem to another. Doing a **df** command, you get the following output:

```

[kern@rufus k]$ df
Filesystem      1k-blocks      Used Available Use% Mounted on
/dev/hda5        5044156    439232  4348692  10% /
/dev/hda1         62193      4935   54047    9% /boot
/dev/hda9       20161172  5524660 13612372  29% /home
/dev/hda2         62217      6843   52161   12% /rescue
/dev/hda8        5044156    42548  4745376   1% /tmp
/dev/hda6        5044156   2613132 2174792  55% /usr
none             127708       0    127708   0% /dev/shm
//minimatou/c$ 14099200  9895424 4203776  71% /mnt/mmatou
lmatou:/         1554264    215884 1258056  15% /mnt/matou
lmatou:/home    2478140   1589952  760072  68% /mnt/matou/home
lmatou:/usr     1981000   1199960  678628  64% /mnt/matou/usr
lpmatou:/        995116     484112  459596  52% /mnt/pmatou
lpmatou:/home   19222656  2787880 15458228 16% /mnt/pmatou/home
lpmatou:/usr    2478140   2038764  311260  87% /mnt/pmatou/usr
deuter:/         4806936     97684  4465064   3% /mnt/deuter
deuter:/home    4806904   280100  4282620   7% /mnt/deuter/home
deuter:/files   44133352  27652876 14238608 67% /mnt/deuter/files

```

And we see that there are a number of separate filesystems (/ /boot /home /rescue /tmp and /usr not to mention mounted systems). If you specify only / in your Include list, Bacula will only save the Filesystem **/dev/hda5**. To save all filesystems except **/tmp** with out including any of the Samba or NFS mounted systems, and explicitly excluding a /tmp, /proc, .journal, and .autofsck, which you will not want to be saved and restored, you can use the following:

```

FileSet {
    Name = Include_example
    Include {
        Options {
            wilddir = /proc
            wilddir = /tmp
            wildfile = "/.journal"
            wildfile = "/.autofsck"
            exclude = yes
        }
        File = /
        File = /boot
        File = /home
        File = /rescue
        File = /usr
    }
}

```

Since /tmp is on its own filesystem and it was not explicitly named in the Include list, it is not really needed in the exclude list. It is better to list it in the Exclude list for clarity, and in case the disks are changed so that it is no longer in its own partition.



Now, let's assume you only want to backup .Z and .gz files and nothing else. This is a bit trickier because Bacula by default will select everything to backup, so we must exclude everything but .Z and .gz files. If we take the first example above and make the obvious modifications to it, we might come up with a FileSet that looks like this:

```
FileSet {
  Name = "Full Set"
  Include {
    Options {
      wilddir = "*.Z"
      wilddir = "*.gz"
    }
    File = /myfile
  }
}
```

!!!!!!!!!!!!

This example doesn't work

!!!!!!!!!!!!

The *.Z and *.gz files will indeed be backed up, but all other files that are not matched by the Options directives will automatically be backed up too (i.e. that is the default rule).

To accomplish what we want, we must explicitly exclude all other files. We do this with the following:

```
FileSet {
  Name = "Full Set"
  Include {
    Options {
      wilddir = "*.Z"
      wilddir = "*.gz"
    }
    Options {
      Exclude = yes
      RegexFile = ".*"
    }
    File = /myfile
  }
}
```

The “trick” here was to add a RegexFile expression that matches all files. It does not match directory names, so all directories in /myfile will be backed up (the directory entry) and any *.Z and *.gz files contained in them. If you know that certain directories do not contain any *.Z or *.gz files and you do not want the directory entries backed up, you will need to explicitly exclude those directories. Backing up a directory entries is not very expensive.

Bacula uses the system regex library and some of them are different on different OSes. The above has been reported not to work on FreeBSD. This can be tested by using the **estimate job=job-name listing** command in the console and adapting the RegexFile expression appropriately. In a future version of Bacula, we will supply our own Regex code to avoid such system dependencies.

Please be aware that allowing Bacula to traverse or change file systems can be **very** dangerous. For example, with the following:

```
FileSet {
  Name = "Bad example"
  Include {
    Options { onefs=no }
    File = /mnt/matou
  }
}
```

you will be backing up an NFS mounted partition (**/mnt/matou**), and since **onefs** is set to **no**, Bacula will traverse file systems. Now if **/mnt/matou** has the current machine's file systems mounted, as is often the case, you will get yourself into a recursive loop and the backup will never end.

As a final example, let's say that you have only one or two subdirectories of /home that you want to backup. For example, you want to backup only subdirectories beginning with the letter a and the letter b – i.e. /home/a* and /home/b*. Now, you might first try:

```
FileSet {
  Name = "Full Set"
  Include {
    Options {
      wilddir = "/home/a*"
      wilddir = "/home/b*"
    }
    File = /home
  }
}
```



The problem is that the above will include everything in /home. To get things to work correctly, you need to start with the idea of exclusion instead of inclusion. So, you could simply exclude all directories except the two you want to use:

```
FileSet {
  Name = "Full Set"
  Include {
    Options {
      RegexDir = "~/home/[c-z]"
      exclude = yes
    }
    File = /home
  }
}
```

And assuming that all subdirectories start with a lowercase letter, this would work. An alternative would be to include the two subdirectories desired and exclude everything else:

```
FileSet {
  Name = "Full Set"
  Include {
    Options {
      wilddir = "/home/a*"
      wilddir = "/home/b*"
    }
    Options {
      RegexDir = ".*"
      exclude = yes
    }
    File = /home
  }
}
```

The following example shows how to back up only the My Pictures directory inside the My Documents directory for all users in C:/Documents and Settings, i.e. everything matching the pattern: C:/Documents and Settings/*/My Documents/My Pictures/*

To understand how this can be achieved, there are two important points to remember:

Firstly, Bacula walks over the filesystem depth-first starting from the File = lines. It stops descending when a directory is excluded, so you must include all ancestor directories of each directory containing files to be included.

Secondly, each directory and file is compared to the Options clauses in the order they appear in the FileSet. When a match is found, no further clauses are compared and the directory or file is either included or excluded.

The FileSet resource definition below implements this by including specific directories and files and excluding everything else.

```
FileSet {
  Name = "AllPictures"

  Include {

    File = "C:/Documents and Settings"

    Options {
      signature = SHA1
      verify = s1
      IgnoreCase = yes

      # Include all users' directories so we reach the inner ones. Unlike a
      # WildDir pattern ending in *, this RegExDir only matches the top-level
      # directories and not any inner ones.
      RegExDir = "^C:/Documents and Settings/[~/]+$"

      # Ditto all users' My Documents directories.
      WildDir = "C:/Documents and Settings/*/My Documents"

      # Ditto all users' My Documents/My Pictures directories.
      WildDir = "C:/Documents and Settings/*/My Documents/My Pictures"

      # Include the contents of the My Documents/My Pictures directories and
      # any subdirectories.
      Wild = "C:/Documents and Settings/*/My Documents/My Pictures/*"
    }
  }
}
```



```

Options {
  Exclude = yes
  IgnoreCase = yes

  # Exclude everything else, in particular any files at the top level and
  # any other directories or files in the users' directories.
  Wild = "C:/Documents and Settings/*"
}
}
}

```

14.9 Backing up Raw Partitions

The following FileSet definition will backup a raw partition:

```

FileSet {
  Name = "RawPartition"
  Include {
    Options { sparse=yes }
    File = /dev/hda2
  }
}

```

While backing up and restoring a raw partition, you should ensure that no other process including the system is writing to that partition. As a precaution, you are strongly urged to ensure that the raw partition is not mounted or is mounted read-only. If necessary, this can be done using the **RunBeforeJob** directive.

14.10 Excluding Files and Directories

You may also include full filenames or directory names in addition to using wild-cards and **Exclude=yes** in the Options resource as specified above by simply including the files to be excluded in an Exclude resource within the FileSet. It accepts wild-cards pattern, so for a directory, don't add a trailing /. For example:

```

FileSet {
  Name = Exclusion_example
  Include {
    Options {
      Signature = SHA1
    }
    File = /
    File = /boot
    File = /home
    File = /rescue
    File = /usr
  }
  Exclude {
    File = /proc
    File = /tmp
    File = .journal
    File = .autofsck
  }
}
}

```

14.11 Windows FileSets

If you are entering Windows file names, the directory path may be preceded by the drive and a colon (as in c:). However, the path separators must be specified in Unix convention (i.e. forward slash (/)). If you wish to include a quote in a file name, precede the quote with a backslash (\). For example you might use the following for a Windows machine to backup the "My Documents" directory:

```

FileSet {
  Name = "Windows Set"
  Include {
    Options {
      WildFile = "*.obj"
      WildFile = "*.exe"
    }
  }
}

```



```

    exclude = yes
  }
  File = "c:/My Documents"
}
}

```

For exclude lists to work correctly on Windows, you must observe the following rules:

- Filenames are case sensitive, so you must use the correct case.
- To exclude a directory, you must not have a trailing slash on the directory name.
- If you have spaces in your filename, you must enclose the entire name in double-quote characters ("). Trying to use a backslash before the space will not work.
- If you are using the old Exclude syntax (noted below), you may not specify a drive letter in the exclude. The new syntax noted above should work fine including driver letters.

Thanks to Thiago Lima for summarizing the above items for us. If you are having difficulties getting includes or excludes to work, you might want to try using the **estimate job=xxx listing** command documented in the **estimate** command (command 1.5 on page 5) of Bacula Community Console Manual.

On Win32 systems, if you move a directory or file or rename a file into the set of files being backed up, and a Full backup has already been made, Bacula will not know there are new files to be saved during an Incremental or Differential backup (blame Microsoft, not me). To avoid this problem, please **copy** any new directory or files into the backup area. If you do not have enough disk to copy the directory or files, move them, but then initiate a Full backup.

A Windows Example FileSet The following example was contributed by Russell Howe. Please note that for presentation purposes, the lines beginning with Data and Internet have been wrapped and should be included on the previous line with one space.

This is my Windows 2000 fileset:

```

FileSet {
  Name = "Windows 2000"
  Include {
    Options {
      signature = MD5
      Exclude = yes
      IgnoreCase = yes
      # Exclude Mozilla-based programs' file caches
      WildDir = "[A-Z]:/Documents and Settings/*/Application
Data/*/Profiles/*/Cache"
      WildDir = "[A-Z]:/Documents and Settings/*/Application
Data/*/Profiles/*/Cache.Trash"
      WildDir = "[A-Z]:/Documents and Settings/*/Application
Data/*/Profiles/*/ImapMail"

      # Exclude user's registry files - they're always in use anyway.
      WildFile = "[A-Z]:/Documents and Settings/*/Local Settings/Application
Data/Microsoft/Windows/userclass.*"
      WildFile = "[A-Z]:/Documents and Settings/*/ntuser.*

      # Exclude directories full of lots and lots of useless little files
      WildDir = "[A-Z]:/Documents and Settings/*/Cookies"
      WildDir = "[A-Z]:/Documents and Settings/*/Recent"
      WildDir = "[A-Z]:/Documents and Settings/*/Local Settings/History"
      WildDir = "[A-Z]:/Documents and Settings/*/Local Settings/Temp"
      WildDir = "[A-Z]:/Documents and Settings/*/Local Settings/Temporary
Internet Files"

      # These are always open and unable to be backed up
      WildFile = "[A-Z]:/Documents and Settings/All Users/Application
Data/Microsoft/Network/Downloader/qmgr[01].dat"

      # Some random bits of Windows we want to ignore
      WildFile = "[A-Z]:/WINNT/security/logs/scepol.log"
      WildDir = "[A-Z]:/WINNT/system32/config"
      WildDir = "[A-Z]:/WINNT/msdownld.tmp"
      WildDir = "[A-Z]:/WINNT/Internet Logs"
      WildDir = "[A-Z]:/WINNT/$Nt*Uninstall*"
      WildDir = "[A-Z]:/WINNT/sysvol"

```



```
WildFile = "[A-Z]:/WINNT/cluster/CLUSDB"
WildFile = "[A-Z]:/WINNT/cluster/CLUSDB.LOG"
WildFile = "[A-Z]:/WINNT/NTDS/edb.log"
WildFile = "[A-Z]:/WINNT/NTDS/ntds.dit"
WildFile = "[A-Z]:/WINNT/NTDS/temp.edb"
WildFile = "[A-Z]:/WINNT/ntfrs/jet/log/edb.log"
WildFile = "[A-Z]:/WINNT/ntfrs/jet/ntfrs.jdb"
WildFile = "[A-Z]:/WINNT/ntfrs/jet/temp/tmp.edb"
WildFile = "[A-Z]:/WINNT/system32/CPL.CFG"
WildFile = "[A-Z]:/WINNT/system32/dhcp/dhcp.mdb"
WildFile = "[A-Z]:/WINNT/system32/dhcp/j50.log"
WildFile = "[A-Z]:/WINNT/system32/dhcp/tmp.edb"
WildFile = "[A-Z]:/WINNT/system32/LServer/edb.log"
WildFile = "[A-Z]:/WINNT/system32/LServer/TLSLic.edb"
WildFile = "[A-Z]:/WINNT/system32/LServer/tmp.edb"
WildFile = "[A-Z]:/WINNT/system32/wins/j50.log"
WildFile = "[A-Z]:/WINNT/system32/wins/wins.mdb"
WildFile = "[A-Z]:/WINNT/system32/wins/winstmp.mdb"

# Temporary directories & files
WildDir = "[A-Z]:/WINNT/Temp"
WildDir = "[A-Z]:/temp"
WildFile = "*.tmp"
WildDir = "[A-Z]:/tmp"
WildDir = "[A-Z]:/var/tmp"

# Recycle bins
WildDir = "[A-Z]:/RECYCLER"

# Swap files
WildFile = "[A-Z]:/pagefile.sys"

# These are programs and are easier to reinstall than restore from
# backup
WildDir = "[A-Z]:/cygwin"
WildDir = "[A-Z]:/Program Files/Grisoft"
WildDir = "[A-Z]:/Program Files/Java"
WildDir = "[A-Z]:/Program Files/Java Web Start"
WildDir = "[A-Z]:/Program Files/JavaSoft"
WildDir = "[A-Z]:/Program Files/Microsoft Office"
WildDir = "[A-Z]:/Program Files/Mozilla Firefox"
WildDir = "[A-Z]:/Program Files/Mozilla Thunderbird"
WildDir = "[A-Z]:/Program Files/mozilla.org"
WildDir = "[A-Z]:/Program Files/OpenOffice*"
}

# Our Win2k boxen all have C: and D: as the main hard drives.
File = "C:/"
File = "D:/"
}
}
```

Note, the three line of the above Exclude were split to fit on the document page, they should be written on a single line in real use.

Windows NTFS Naming Considerations NTFS filenames containing Unicode characters should now be supported as of version 1.37.30 or later.

14.12 Testing Your FileSet

If you wish to get an idea of what your FileSet will really backup or if your exclusion rules will work correctly, you can test it by using the **estimate** command in the Console program. See the **estimate** command (command 1.5 on page 5) of Bacula Community Console Manual.

As an example, suppose you add the following test FileSet:

```
FileSet {
  Name = Test
  Include {
    File = /home/xxx/test
    Options {
      regex = ".*\\.c$"
    }
  }
}
```



```
}
}
```

You could then add some test files to the directory `/home/xxx/test` and use the following command in the console:

```
estimate job=<any-job-name> listing client=<desired-client> fileset=Test
```

to give you a listing of all files that match. In the above example, it should be only files with names ending in `.c`.

14.13 The Client Resource

The Client resource defines the attributes of the Clients that are served by this Director; that is the machines that are to be backed up. You will need one Client resource definition for each machine to be backed up.

Client (or FileDaemon) Start of the Client directives.

Name = `<name>` The client name which will be used in the Job resource directive or in the console run command. This directive is required.

Address = `<address>` Where the address is a host name, a fully qualified domain name, or a network address in dotted quad notation for a Bacula File server daemon. This directive is required.

FD Port = `<port-number>` Where the port is a port number at which the Bacula File server daemon can be contacted. The default is 9102.

Catalog = `<Catalog-resource-name>` This specifies the name of the catalog resource to be used for this Client. This directive is required.

Password = `<password>` This is the password to be used when establishing a connection with the File services, so the Client configuration file on the machine to be backed up must have the same password defined for this Director. This directive is required. If you have either `/dev/random` or `bc` on your machine, Bacula will generate a random password during the configuration process, otherwise it will be left blank.

The password is plain text. It is not generated through any special process, but it is preferable for security reasons to make the text random.

File Retention = `<time-period-specification>` The File Retention directive defines the length of time that Bacula will keep File records in the Catalog database after the End time of the Job corresponding to the File records. When this time period expires, and if **AutoPrune** is set to **yes** Bacula will prune (remove) File records that are older than the specified File Retention period. Note, this affects only records in the catalog database. It does not affect your archive backups.

File records may actually be retained for a shorter period than you specify on this directive if you specify either a shorter **Job Retention** or a shorter **Volume Retention** period. The shortest retention period of the three takes precedence. The time may be expressed in seconds, minutes, hours, days, weeks, months, quarters, or years. See the Configuration chapter of this manual for additional details of time specification.

The default is 60 days.

Job Retention = `<time-period-specification>` The Job Retention directive defines the length of time that Bacula will keep Job records in the Catalog database after the Job End time. When this time period expires, and if **AutoPrune** is set to **yes** Bacula will prune (remove) Job records that are older than the specified File Retention period. As with the other retention periods, this affects only records in the catalog and not data in your archive backup.

If a Job record is selected for pruning, all associated File and JobMedia records will also be pruned regardless of the File Retention period set. As a consequence, you normally will set the File retention period to be less than the Job retention period. The Job retention period can actually be less than the value you specify here if you set the **Volume Retention** directive in the Pool resource to a smaller duration. This is because the Job retention period and the Volume retention period are independently applied, so the smaller of the two takes precedence.



The Job retention period is specified as seconds, minutes, hours, days, weeks, months, quarters, or years. See the Configuration chapter of this manual for additional details of time specification.

The default is 180 days.

AutoPrune = `<yes|no>` If AutoPrune is set to **yes** (default), Bacula (version 1.20 or greater) will automatically apply the File retention period and the Job retention period for the Client at the end of the Job. If you set **AutoPrune** = **no**, pruning will not be done, and your Catalog will grow in size each time you run a Job. Pruning affects only information in the catalog and not data stored in the backup archives (on Volumes).

Maximum Concurrent Jobs = `<number>` where `<number>` is the maximum number of Jobs with the current Client that can run concurrently. Note, this directive limits only Jobs for Clients with the same name as the resource in which it appears. Any other restrictions on the maximum concurrent jobs such as in the Director, Job, or Storage resources will also apply in addition to any limit specified here. The default is set to 1, but you may set it to a larger number.

Maximum Bandwidth Per Job = `<speed>` The speed parameter specifies the maximum allowed bandwidth that a job may use when started for this Client. The speed parameter should be specified in k/s, Kb/s, m/s or Mb/s.

Priority = `<number>` The number specifies the priority of this client relative to other clients that the Director is processing simultaneously. The priority can range from 1 to 1000. The clients are ordered such that the smaller number priorities are performed first (not currently implemented).

The following is an example of a valid Client resource definition:

```
Client {
  Name = Minimatou
  FDAddress = minimatou
  Catalog = MySQL
  Password = very_good
}
```

14.14 The Storage Resource

The Storage resource defines which Storage daemons are available for use by the Director.

Storage Start of the Storage resources. At least one storage resource must be specified.

Name = `<name>` The name of the storage resource. This name appears on the Storage directive specified in the Job resource and is required.

Address = `<address>` Where the address is a host name, a **fully qualified domain name**, or an **IP address**. Please note that the `<address>` as specified here will be transmitted to the File daemon who will then use it to contact the Storage daemon. Hence, it is **not**, a good idea to use **localhost** as the name but rather a fully qualified machine name or an IP address. This directive is required.

SD Port = `<port>` Where port is the port to use to contact the storage daemon for information and to start jobs. This same port number must appear in the Storage resource of the Storage daemon's configuration file. The default is 9103.

Password = `<password>` This is the password to be used when establishing a connection with the Storage services. This same password also must appear in the Director resource of the Storage daemon's configuration file. This directive is required. If you have either `/dev/random` or `bc` on your machine, Bacula will generate a random password during the configuration process, otherwise it will be left blank.

The password is plain text. It is not generated through any special process, but it is preferable for security reasons to use random text.

Device = `<device-name>` This directive specifies the Storage daemon's name of the device resource to be used for the storage. If you are using an Autochanger, the name specified here should be the name of the Storage daemon's Autochanger resource rather than the name of an individual device. This name is not the physical device name, but the logical device name as defined on the **Name** directive contained in the **Device** or the **Autochanger** resource definition of the **Storage daemon** configuration file.



You can specify any name you would like (even the device name if you prefer) up to a maximum of 127 characters in length. The physical device name associated with this device is specified in the **Storage daemon** configuration file (as **Archive Device**). Please take care not to define two different Storage resource directives in the Director that point to the same Device in the Storage daemon. Doing so may cause the Storage daemon to block (or hang) attempting to open the same device that is already open. This directive is required.

Media Type = <**MediaType**> This directive specifies the Media Type to be used to store the data. This is an arbitrary string of characters up to 127 maximum that you define. It can be anything you want. However, it is best to make it descriptive of the storage media (e.g. File, DAT, "HP DLT8000", 8mm, ...). In addition, it is essential that you make the **Media Type** specification unique for each storage media type. If you have two DDS-4 drives that have incompatible formats, or if you have a DDS-4 drive and a DDS-4 autochanger, you almost certainly should specify different **Media Types**. During a restore, assuming a **DDS-4** Media Type is associated with the Job, Bacula can decide to use any Storage daemon that supports Media Type **DDS-4** and on any drive that supports it.

If you are writing to disk Volumes, you must make doubly sure that each Device resource defined in the Storage daemon (and hence in the Director's conf file) has a unique media type. Otherwise for Bacula versions 1.38 and older, your restores may not work because Bacula will assume that you can mount any Media Type with the same name on any Device associated with that Media Type. This is possible with tape drives, but with disk drives, unless you are very clever you cannot mount a Volume in any directory – this can be done by creating an appropriate soft link.

Currently Bacula permits only a single Media Type per Storage and Device definition. Consequently, if you have a drive that supports more than one Media Type, you can give a unique string to Volumes with different intrinsic Media Type (Media Type = DDS-3-4 for DDS-3 and DDS-4 types), but then those volumes will only be mounted on drives indicated with the dual type (DDS-3-4).

If you want to tie Bacula to using a single Storage daemon or drive, you must specify a unique Media Type for that drive. This is an important point that should be carefully understood. Note, this applies equally to Disk Volumes. If you define more than one disk Device resource in your Storage daemon's conf file, the Volumes on those two devices are in fact incompatible because one can not be mounted on the other device since they are found in different directories. For this reason, you probably should use two different Media Types for your two disk Devices (even though you might think of them as both being File types). You can find more on this subject in the Basic Volume Management chapter of this manual.

The **MediaType** specified in the Director's Storage resource, **must** correspond to the **Media Type** specified in the **Device** resource of the **Storage daemon** configuration file. This directive is required, and it is used by the Director and the Storage daemon to ensure that a Volume automatically selected from the Pool corresponds to the physical device. If a Storage daemon handles multiple devices (e.g. will write to various file Volumes on different partitions), this directive allows you to specify exactly which device.

As mentioned above, the value specified in the Director's Storage resource must agree with the value specified in the Device resource in the **Storage daemon's** configuration file. It is also an additional check so that you don't try to write data for a DLT onto an 8mm device.

Autochanger = <**yes|no**> If you specify **yes** for this command (the default is **no**), when you use the **label** command or the **add** command to create a new Volume, **Bacula** will also request the Autochanger Slot number. This simplifies creating database entries for Volumes in an autochanger. If you forget to specify the Slot, the autochanger will not be used. However, you may modify the Slot associated with a Volume at any time by using the **update volume** or **update slots** command in the console program. When **autochanger** is enabled, the algorithm used by Bacula to search for available volumes will be modified to consider only Volumes that are known to be in the autochanger's magazine. If no **in changer** volume is found, Bacula will attempt recycling, pruning, ..., and if still no volume is found, Bacula will search for any volume whether or not in the magazine. By privileging in changer volumes, this procedure minimizes operator intervention. The default is **no**.

For the autochanger to be used, you must also specify **Autochanger = yes** in the Device Resource in the Storage daemon's configuration file as well as other important Storage daemon configuration information. Please consult the Using Autochangers manual of this chapter for the details of using autochangers.

Maximum Concurrent Jobs = <**number**> where <number> is the maximum number of Jobs with the current Storage resource that can run concurrently. Note, this directive limits only Jobs for Jobs using



this Storage daemon. Any other restrictions on the maximum concurrent jobs such as in the Director, Job, or Client resources will also apply in addition to any limit specified here. The default is set to 1, but you may set it to a larger number. However, if you set the Storage daemon's number of concurrent jobs greater than one, we recommend that you read the warning documented under Maximum Concurrent Jobs in the Director's resource or simply turn data spooling on as documented in the Data Spooling chapter of this manual.

AllowCompression = <yes|no> This directive is optional, and if you specify **No** (the default is **Yes**), it will cause backups jobs running on this storage resource to run without client File Daemon compression. This effectively overrides compression options in FileSets used by jobs which use this storage resource.

Heartbeat Interval = <time-interval> This directive is optional and if specified will cause the Director to set a keepalive interval (heartbeat) in seconds on each of the sockets it opens for the Storage resource. This value will override any specified at the Director level. It is implemented only on systems (Linux, ...) that provide the **setsockopt** TCP_KEEPIIDLE function. The default value is zero, which means no change is made to the socket.

The following is an example of a valid Storage resource definition:

```
# Definition of tape storage device
Storage {
    Name = DLTDrive
    Address = lpmatou
    Password = storage_password # password for Storage daemon
    Device = "HP DLT 80"        # same as Device in Storage daemon
    Media Type = DLT8000       # same as MediaType in Storage daemon
}
```

14.15 The Pool Resource

The Pool resource defines the set of storage Volumes (tapes or files) to be used by Bacula to write the data. By configuring different Pools, you can determine which set of Volumes (media) receives the backup data. This permits, for example, to store all full backup data on one set of Volumes and all incremental backups on another set of Volumes. Alternatively, you could assign a different set of Volumes to each machine that you backup. This is most easily done by defining multiple Pools.

Another important aspect of a Pool is that it contains the default attributes (Maximum Jobs, Retention Period, Recycle flag, ...) that will be given to a Volume when it is created. This avoids the need for you to answer a large number of questions when labeling a new Volume. Each of these attributes can later be changed on a Volume by Volume basis using the **update** command in the console program. Note that you must explicitly specify which Pool Bacula is to use with each Job. Bacula will not automatically search for the correct Pool.

Most often in Bacula installations all backups for all machines (Clients) go to a single set of Volumes. In this case, you will probably only use the **Default** Pool. If your backup strategy calls for you to mount a different tape each day, you will probably want to define a separate Pool for each day. For more information on this subject, please see the Backup Strategies chapter of this manual.

To use a Pool, there are three distinct steps. First the Pool must be defined in the Director's configuration file. Then the Pool must be written to the Catalog database. This is done automatically by the Director each time that it starts, or alternatively can be done using the **create** command in the console program. Finally, if you change the Pool definition in the Director's configuration file and restart Bacula, the pool will be updated alternatively you can use the **update pool** console command to refresh the database image. It is this database image rather than the Director's resource image that is used for the default Volume attributes. Note, for the pool to be automatically created or updated, it must be explicitly referenced by a Job resource. Next the physical media must be labeled. The labeling can either be done with the **label** command in the **console** program or using the **btape** program. The preferred method is to use the **label** command in the **console** program.

Finally, you must add Volume names (and their attributes) to the Pool. For Volumes to be used by Bacula they must be of the same **Media Type** as the archive device specified for the job (i.e. if you are going to back up to a DLT device, the Pool must have DLT volumes defined since 8mm volumes cannot be mounted on a DLT drive). The **Media Type** has particular importance if you are backing up to files. When running a Job, you must explicitly specify which Pool to use. Bacula will then automatically select the next Volume to use from the Pool, but it will ensure that the **Media Type** of any Volume selected from the Pool is identical to that required by the Storage resource you have specified for the Job.

If you use the **label** command in the console program to label the Volumes, they will automatically be added to the Pool, so this last step is not normally required.

It is also possible to add Volumes to the database without explicitly labeling the physical volume. This is done with the **add** console command.

As previously mentioned, each time Bacula starts, it scans all the Pools associated with each Catalog, and if the database record does not already exist, it will be created from the Pool Resource definition. **Bacula** probably should do an **update pool** if you change the Pool definition, but currently, you must do this manually using the **update pool** command in the Console program.

The Pool Resource defined in the Director's configuration file (`bacula-dir.conf`) may contain the following directives:

Pool Start of the Pool resource. There must be at least one Pool resource defined.

Name = <name> The name of the pool. For most applications, you will use the default pool name **Default**. This directive is required.

Maximum Volumes = <number> This directive specifies the maximum number of volumes (tapes or files) contained in the pool. This directive is optional, if omitted or set to zero, any number of volumes will be permitted. In general, this directive is useful for Autochangers where there is a fixed number of Volumes, or for File storage where you wish to ensure that the backups made to disk files do not become too numerous or consume too much space.

Pool Type = <type> This directive defines the pool type, which corresponds to the type of Job being run. It is required and may be one of the following:

- Backup
- *Archive
- *Cloned
- *Migration
- *Copy
- *Save

Note, only Backup is current implemented.

Storage = <storage-resource-name> The Storage directive defines the name of the storage services where you want to backup the FileSet data. For additional details, see the Storage Resource Chapter of this manual. The Storage resource may also be specified in the Job resource, but the value, if any, in the Pool resource overrides any value in the Job. This Storage resource definition is not required by either the Job resource or in the Pool, but it must be specified in one or the other. If not configuration error will result.

Use Volume Once = <yes|no> This directive if set to **yes** specifies that each volume is to be used only once. This is most useful when the Media is a file and you want a new file for each backup that is done. The default is **no** (i.e. use volume any number of times). This directive will most likely be phased out (deprecated), so you are recommended to use **Maximum Volume Jobs = 1** instead.

The value defined by this directive in the `bacula-dir.conf` file is the default value used when a Volume is created. Once the volume is created, changing the value in the `bacula-dir.conf` file will not change what is stored for the Volume. To change the value for an existing Volume you must use the **update** command in the Console.

Please see the notes below under **Maximum Volume Jobs** concerning using this directive with multiple simultaneous jobs.

Maximum Volume Jobs = <positive-integer> This directive specifies the maximum number of Jobs that can be written to the Volume. If you specify zero (the default), there is no limit. Otherwise, when the number of Jobs backed up to the Volume equals **positive-integer** the Volume will be marked **Used**. When the Volume is marked **Used** it can no longer be used for appending Jobs, much like the **Full** status but it can be recycled if recycling is enabled, and thus used again. By setting **MaximumVolumeJobs** to one, you get the same effect as setting **UseVolumeOnce = yes**.

The value defined by this directive in the `bacula-dir.conf` file is the default value used when a Volume is created. Once the volume is created, changing the value in the `bacula-dir.conf` file will not change



what is stored for the Volume. To change the value for an existing Volume you must use the **update** command in the Console.

If you are running multiple simultaneous jobs, this directive may not work correctly because when a drive is reserved for a job, this directive is not taken into account, so multiple jobs may try to start writing to the Volume. At some point, when the Media record is updated, multiple simultaneous jobs may fail since the Volume can no longer be written.

Maximum Volume Files = <positive-integer> This directive specifies the maximum number of files that can be written to the Volume. If you specify zero (the default), there is no limit. Otherwise, when the number of files written to the Volume equals **positive-integer** the Volume will be marked **Used**. When the Volume is marked **Used** it can no longer be used for appending Jobs, much like the **Full** status but it can be recycled if recycling is enabled and thus used again. This value is checked and the **Used** status is set only at the end of a job that writes to the particular volume.

The value defined by this directive in the bacula-dir.conf file is the default value used when a Volume is created. Once the volume is created, changing the value in the bacula-dir.conf file will not change what is stored for the Volume. To change the value for an existing Volume you must use the **update** command in the Console.

Maximum Volume Bytes = <size> This directive specifies the maximum number of bytes that can be written to the Volume. If you specify zero (the default), there is no limit except the physical size of the Volume. Otherwise, when the number of bytes written to the Volume equals **size** the Volume will be marked **Used**. When the Volume is marked **Used** it can no longer be used for appending Jobs, much like the **Full** status but it can be recycled if recycling is enabled, and thus the Volume can be re-used after recycling. This value is checked and the **Used** status set while the job is writing to the particular volume.

This directive is particularly useful for restricting the size of disk volumes, and will work correctly even in the case of multiple simultaneous jobs writing to the volume.

The value defined by this directive in the bacula-dir.conf file is the default value used when a Volume is created. Once the volume is created, changing the value in the bacula-dir.conf file will not change what is stored for the Volume. To change the value for an existing Volume you must use the **update** command in the Console.

Volume Use Duration = <time-period-specification> The Volume Use Duration directive defines the time period that the Volume can be written beginning from the time of first data write to the Volume. If the time-period specified is zero (the default), the Volume can be written indefinitely. Otherwise, the next time a job runs that wants to access this Volume, and the time period from the first write to the volume (the first Job written) exceeds the time-period-specification, the Volume will be marked **Used**, which means that no more Jobs can be appended to the Volume, but it may be recycled if recycling is enabled. Using the command **status dir** applies algorithms similar to running jobs, so during such a command, the Volume status may also be changed. Once the Volume is recycled, it will be available for use again.

You might use this directive, for example, if you have a Volume used for Incremental backups, and Volumes used for Weekly Full backups. Once the Full backup is done, you will want to use a different Incremental Volume. This can be accomplished by setting the Volume Use Duration for the Incremental Volume to six days. I.e. it will be used for the 6 days following a Full save, then a different Incremental volume will be used. Be careful about setting the duration to short periods such as 23 hours, or you might experience problems of Bacula waiting for a tape over the weekend only to complete the backups Monday morning when an operator mounts a new tape.

The use duration is checked and the **Used** status is set only at the end of a job that writes to the particular volume, which means that even though the use duration may have expired, the catalog entry will not be updated until the next job that uses this volume is run. This directive is not intended to be used to limit volume sizes and will not work correctly (i.e. will fail jobs) if the use duration expires while multiple simultaneous jobs are writing to the volume.

Please note that the value defined by this directive in the bacula-dir.conf file is the default value used when a Volume is created. Once the volume is created, changing the value in the bacula-dir.conf file will not change what is stored for the Volume. To change the value for an existing Volume you must use the **update volume** command (command 1.5 on page 14) in the Bacula Community Console Manual.

Catalog Files = <yes|no> This directive defines whether or not you want the names of the files that were saved to be put into the catalog. The default is **yes**. The advantage of specifying **Catalog Files = No** is that you will have a significantly smaller Catalog database. The disadvantage is that you will not be able to produce a Catalog listing of the files backed up for each Job (this is often called Browsing). Also, without the File entries in the catalog, you will not be able to use the Console **restore** command nor any other command that references File entries.

AutoPrune = <yes|no> If AutoPrune is set to **yes** (default), Bacula (version 1.20 or greater) will automatically apply the Volume Retention period when new Volume is needed and no appendable Volumes exist in the Pool. Volume pruning causes expired Jobs (older than the **Volume Retention** period) to be deleted from the Catalog and permits possible recycling of the Volume.

Volume Retention = <time-period-specification> The Volume Retention directive defines the length of time that **Bacula** will keep records associated with the Volume in the Catalog database after the End time of each Job written to the Volume. When this time period expires, and if **AutoPrune** is set to **yes** Bacula may prune (remove) Job records that are older than the specified Volume Retention period if it is necessary to free up a Volume. Recycling will not occur until it is absolutely necessary to free up a volume (i.e. no other writable volume exists). All File records associated with pruned Jobs are also pruned. The time may be specified as seconds, minutes, hours, days, weeks, months, quarters, or years. The **Volume Retention** is applied independently of the **Job Retention** and the **File Retention** periods defined in the Client resource. This means that all the retentions periods are applied in turn and that the shorter period is the one that effectively takes precedence. Note, that when the **Volume Retention** period has been reached, and it is necessary to obtain a new volume, Bacula will prune both the Job and the File records. This pruning could also occur during a **status dir** command because it uses similar algorithms for finding the next available Volume.

It is important to know that when the Volume Retention period expires, Bacula does not automatically recycle a Volume. It attempts to keep the Volume data intact as long as possible before over writing the Volume.

By defining multiple Pools with different Volume Retention periods, you may effectively have a set of tapes that is recycled weekly, another Pool of tapes that is recycled monthly and so on. However, one must keep in mind that if your **Volume Retention** period is too short, it may prune the last valid Full backup, and hence until the next Full backup is done, you will not have a complete backup of your system, and in addition, the next Incremental or Differential backup will be promoted to a Full backup. As a consequence, the minimum **Volume Retention** period should be at twice the interval of your Full backups. This means that if you do a Full backup once a month, the minimum Volume retention period should be two months.

The default Volume retention period is 365 days, and either the default or the value defined by this directive in the bacula-dir.conf file is the default value used when a Volume is created. Once the volume is created, changing the value in the bacula-dir.conf file will not change what is stored for the Volume. To change the value for an existing Volume you must use the **update** command in the Console.

Action On Purge = <Truncate This directive **ActionOnPurge=Truncate** instructs Bacula to truncate the volume when it is purged with the **purge volume action=truncate** command. It is useful to prevent disk based volumes from consuming too much space.

```
Pool {
  Name = Default
  Action On Purge = Truncate
  ...
}
```

You can schedule the truncate operation at the end of your CatalogBackup job like in this example:

```
Job {
  Name = CatalogBackup
  ...
  RunScript {
    RunsWhen=After
    RunsOnClient=No
    Console = "purge volume action=all allpools storage=File"
```



```
}  
}
```

ScratchPool = <pool-resource-name> This directive permits to specify a dedicate *Scratch* for the current pool. This pool will replace the special pool named *Scrach* for volume selection. For more information about *Scratch* see Scratch Pool section of this manual. This is useful when using multiple storage sharing the same mediatype or when you want to dedicate volumes to a particular set of pool.

RecyclePool = <pool-resource-name> This directive defines to which pool the Volume will be placed (moved) when it is recycled. Without this directive, a Volume will remain in the same pool when it is recycled. With this directive, it can be moved automatically to any existing pool during a recycle. This directive is probably most useful when defined in the Scratch pool, so that volumes will be recycled back into the Scratch pool. For more on the see the Scratch Pool section of this manual.

Although this directive is called **RecyclePool**, the Volume in question is actually moved from its current pool to the one you specify on this directive when Bacula prunes the Volume and discovers that there are no records left in the catalog and hence marks it as **Purged**.

Recycle = <yes|no> This directive specifies whether or not Purged Volumes may be recycled. If it is set to **yes** (default) and Bacula needs a volume but finds none that are appendable, it will search for and recycle (reuse) Purged Volumes (i.e. volumes with all the Jobs and Files expired and thus deleted from the Catalog). If the Volume is recycled, all previous data written to that Volume will be overwritten. If **Recycle** is set to **no**, the Volume will not be recycled, and hence, the data will remain valid. If you want to reuse (re-write) the Volume, and the recycle flag is no (0 in the catalog), you may manually set the recycle flag (update command) for a Volume to be reused.

Please note that the value defined by this directive in the bacula-dir.conf file is the default value used when a Volume is created. Once the volume is created, changing the value in the bacula-dir.conf file will not change what is stored for the Volume. To change the value for an existing Volume you must use the **update** command in the Console.

When all Job and File records have been pruned or purged from the catalog for a particular Volume, if that Volume is marked as Append, Full, Used, or Error, it will then be marked as Purged. Only Volumes marked as Purged will be considered to be converted to the Recycled state if the **Recycle** directive is set to **yes**.

Recycle Oldest Volume = <yes|no> This directive instructs the Director to search for the oldest used Volume in the Pool when another Volume is requested by the Storage daemon and none are available. The catalog is then **pruned** respecting the retention periods of all Files and Jobs written to this Volume. If all Jobs are pruned (i.e. the volume is Purged), then the Volume is recycled and will be used as the next Volume to be written. This directive respects any Job, File, or Volume retention periods that you may have specified, and as such it is **much** better to use this directive than the Purge Oldest Volume.

This directive can be useful if you have a fixed number of Volumes in the Pool and you want to cycle through them and you have specified the correct retention periods.

However, if you use this directive and have only one Volume in the Pool, you will immediately recycle your Volume if you fill it and Bacula needs another one. Thus your backup will be totally invalid. Please use this directive with care. The default is **no**.

Recycle Current Volume = <yes|no> If Bacula needs a new Volume, this directive instructs Bacula to Prune the volume respecting the Job and File retention periods. If all Jobs are pruned (i.e. the volume is Purged), then the Volume is recycled and will be used as the next Volume to be written. This directive respects any Job, File, or Volume retention periods that you may have specified, and thus it is **much** better to use it rather than the Purge Oldest Volume directive.

This directive can be useful if you have: a fixed number of Volumes in the Pool, you want to cycle through them, and you have specified retention periods that prune Volumes before you have cycled through the Volume in the Pool.

However, if you use this directive and have only one Volume in the Pool, you will immediately recycle your Volume if you fill it and Bacula needs another one. Thus your backup will be totally invalid. Please use this directive with care. The default is **no**.



Purge Oldest Volume = <yes|no> This directive instructs the Director to search for the oldest used Volume in the Pool when another Volume is requested by the Storage daemon and none are available. The catalog is then **purged** irrespective of retention periods of all Files and Jobs written to this Volume. The Volume is then recycled and will be used as the next Volume to be written. This directive overrides any Job, File, or Volume retention periods that you may have specified.

This directive can be useful if you have a fixed number of Volumes in the Pool and you want to cycle through them and reusing the oldest one when all Volumes are full, but you don't want to worry about setting proper retention periods. However, by using this option you risk losing valuable data.

Please be aware that **Purge Oldest Volume** disregards all retention periods. If you have only a single Volume defined and you turn this variable on, that Volume will always be immediately overwritten when it fills! So at a minimum, ensure that you have a decent number of Volumes in your Pool before running any jobs. If you want retention periods to apply do not use this directive. To specify a retention period, use the **Volume Retention** directive (see above).

We **highly** recommend against using this directive, because it is sure that some day, Bacula will recycle a Volume that contains current data. The default is **no**.

File Retention = <time-period-specification> The File Retention directive defines the length of time that Bacula will keep File records in the Catalog database after the End time of the Job corresponding to the File records.

This directive takes precedence over Client directives of the same name. For example, you can decide to increase Retention times for Archive or OffSite Pool.

Note, this affects only records in the catalog database. It does not affect your archive backups.

For more information see Client documentation about FileRetention

Job Retention = <time-period-specification> The Job Retention directive defines the length of time that Bacula will keep Job records in the Catalog database after the Job End time. As with the other retention periods, this affects only records in the catalog and not data in your archive backup.

This directive takes precedence over Client directives of the same name. For example, you can decide to increase Retention times for Archive or OffSite Pool.

For more information see Client side documentation JobRetention

Cleaning Prefix = <string> This directive defines a prefix string, which if it matches the beginning of a Volume name during labeling of a Volume, the Volume will be defined with the VolStatus set to **Cleaning** and thus Bacula will never attempt to use this tape. This is primarily for use with autochangers that accept barcodes where the convention is that barcodes beginning with **CLN** are treated as cleaning tapes.

Label Format = <format> This directive specifies the format of the labels contained in this pool. The format directive is used as a sort of template to create new Volume names during automatic Volume labeling.

The **format** should be specified in double quotes, and consists of letters, numbers and the special characters hyphen (-), underscore (_), colon (:), and period (.), which are the legal characters for a Volume name. The **format** should be enclosed in double quotes ("").

In addition, the format may contain a number of variable expansion characters which will be expanded by a complex algorithm allowing you to create Volume names of many different formats. In all cases, the expansion process must resolve to the set of characters noted above that are legal Volume names. Generally, these variable expansion characters begin with a dollar sign (\$) or a left bracket ([). If you specify variable expansion characters, you should always enclose the format with double quote characters (""). For more details on variable expansion, please see the **Variable Expansion** chapter (chapter 2 on page 9) of the Bacula Community Misc Manual.

If no variable expansion characters are found in the string, the Volume name will be formed from the **format** string appended with the a unique number that increases. If you do not remove volumes from the pool, this number should be the number of volumes plus one, but this is not guaranteed. The unique number will be edited as four digits with leading zeros. For example, with a **Label Format** = **"File-"**, the first volumes will be named **File-0001**, **File-0002**, ...

With the exception of Job specific variables, you can test your **LabelFormat** by using the **var** command (command 1.5 on page 15) in the Bacula Community Console Manual.



In almost all cases, you should enclose the format specification (part after the equal sign) in double quotes. Please note that this directive is deprecated and is replaced in version 1.37 and greater with a Python script for creating volume names.

In order for a Pool to be used during a Backup Job, the Pool must have at least one Volume associated with it. Volumes are created for a Pool using the **label** or the **add** commands in the **Bacula Console**, program. In addition to adding Volumes to the Pool (i.e. putting the Volume names in the Catalog database), the physical Volume must be labeled with a valid Bacula software volume label before **Bacula** will accept the Volume. This will be automatically done if you use the **label** command. Bacula can automatically label Volumes if instructed to do so, but this feature is not yet fully implemented.

The following is an example of a valid Pool resource definition:

```
Pool {
  Name = Default
  Pool Type = Backup
}
```

14.15.1 The Scratch Pool

In general, you can give your Pools any name you wish, but there is one important restriction: the Pool named **Scratch**, if it exists behaves like a scratch pool of Volumes in that when Bacula needs a new Volume for writing and it cannot find one, it will look in the Scratch pool, and if it finds an available Volume, it will move it out of the Scratch pool into the Pool currently being used by the job.

14.16 The Catalog Resource

The Catalog Resource defines what catalog to use for the current job. Currently, Bacula can only handle a single database server (SQLite, MySQL, PostgreSQL) that is defined when configuring **Bacula**. However, there may be as many Catalogs (databases) defined as you wish. For example, you may want each Client to have its own Catalog database, or you may want backup jobs to use one database and verify or restore jobs to use another database.

Since SQLite is compiled in, it always runs on the same machine as the Director and the database must be directly accessible (mounted) from the Director. However, since both MySQL and PostgreSQL are networked databases, they may reside either on the same machine as the Director or on a different machine on the network. See below for more details.

Catalog Start of the Catalog resource. At least one Catalog resource must be defined.

Name = <name> The name of the Catalog. No necessary relation to the database server name. This name will be specified in the Client resource directive indicating that all catalog data for that Client is maintained in this Catalog. This directive is required.

password = <password> This specifies the password to use when logging into the database. This directive is required.

DB Name = <name> This specifies the name of the database. If you use multiple catalogs (databases), you specify which one here. If you are using an external database server rather than the internal one, you must specify a name that is known to the server (i.e. you explicitly created the Bacula tables using this name. This directive is required.

user = <user> This specifies what user name to use to log into the database. This directive is required.

DB Socket = <socket-name> This is the name of a socket to use on the local host to connect to the database. This directive is used only by MySQL and is ignored by SQLite. Normally, if neither **DB Socket** or **DB Address** are specified, MySQL will use the default socket. If the DB Socket is specified, the MySQL server must reside on the same machine as the Director.

DB Address = <address> This is the host address of the database server. Normally, you would specify this instead of **DB Socket** if the database server is on another machine. In that case, you will also specify **DB Port**. This directive is used only by MySQL and PostgreSQL and is ignored by SQLite if provided. This directive is optional.



DB Port = <port> This defines the port to be used in conjunction with **DB Address** to access the database if it is on another machine. This directive is used only by MySQL and PostgreSQL and is ignored by SQLite if provided. This directive is optional.

the different

The following is an example of a valid Catalog resource definition:

```
Catalog
{
  Name = SQLite
  dbname = bacula;
  user = bacula;
  password = ""                # no password = no security
}
```

or for a Catalog on another machine:

```
Catalog
{
  Name = MySQL
  dbname = bacula
  user = bacula
  password = ""
  DB Address = remote.acme.com
  DB Port = 1234
}
```

14.17 The Messages Resource

For the details of the Messages Resource, please see the Messages Resource Chapter of this manual.

14.18 The Console Resource

As of Bacula version 1.33 and higher, there are three different kinds of consoles, which the administrator or user can use to interact with the Director. These three kinds of consoles comprise three different security levels.

- The first console type is an **anonymous** or **default** console, which has full privileges. There is no console resource necessary for this type since the password is specified in the Director's resource and consequently such consoles do not have a name as defined on a **Name =** directive. This is the kind of console that was initially implemented in versions prior to 1.33 and remains valid. Typically you would use it only for administrators.
- The second type of console, and new to version 1.33 and higher is a "named" console defined within a Console resource in both the Director's configuration file and in the Console's configuration file. Both the names and the passwords in these two entries must match much as is the case for Client programs. This second type of console begins with absolutely no privileges except those explicitly specified in the Director's Console resource. Thus you can have multiple Consoles with different names and passwords, sort of like multiple users, each with different privileges. As a default, these consoles can do absolutely nothing – no commands whatsoever. You give them privileges or rather access to commands and resources by specifying access control lists in the Director's Console resource. The ACLs are specified by a directive followed by a list of access names. Examples of this are shown below.
- The third type of console is similar to the above mentioned one in that it requires a Console resource definition in both the Director and the Console. In addition, if the console name, provided on the **Name =** directive, is the same as a Client name, that console is permitted to use the **SetIP** command to change the Address directive in the Director's client resource to the IP address of the Console. This permits portables or other machines using DHCP (non-fixed IP addresses) to "notify" the Director of their current IP address.

The Console resource is optional and need not be specified. The following directives are permitted within the Director's configuration resource:

Name = <name> The name of the console. This name must match the name specified in the Console's configuration resource (much as is the case with Client definitions).



Password = `<password>` Specifies the password that must be supplied for a named Bacula Console to be authorized. The same password must appear in the **Console** resource of the Console configuration file. For added security, the password is never actually passed across the network but rather a challenge response hash code created with the password. This directive is required. If you have either `/dev/random` or `bc` on your machine, Bacula will generate a random password during the configuration process, otherwise it will be left blank.

The password is plain text. It is not generated through any special process. However, it is preferable for security reasons to choose random text.

JobACL = `<name-list>` This directive is used to specify a list of Job resource names that can be accessed by the console. Without this directive, the console cannot access any of the Director's Job resources. Multiple Job resource names may be specified by separating them with commas, and/or by specifying multiple JobACL directives. For example, the directive may be specified as:

```
JobACL = kernsave, "Backup client 1", "Backup client 2"
JobACL = "RestoreFiles"
```

With the above specification, the console can access the Director's resources for the four jobs named on the JobACL directives, but for no others.

ClientACL = `<name-list>` This directive is used to specify a list of Client resource names that can be accessed by the console.

StorageACL = `<name-list>` This directive is used to specify a list of Storage resource names that can be accessed by the console.

ScheduleACL = `<name-list>` This directive is used to specify a list of Schedule resource names that can be accessed by the console.

PoolACL = `<name-list>` This directive is used to specify a list of Pool resource names that can be accessed by the console.

FileSetACL = `<name-list>` This directive is used to specify a list of FileSet resource names that can be accessed by the console.

CatalogACL = `<name-list>` This directive is used to specify a list of Catalog resource names that can be accessed by the console.

CommandACL = `<name-list>` This directive is used to specify a list of console commands that can be executed by the console.

WhereACL = `<string>` This directive permits you to specify where a restricted console can restore files. If this directive is not specified, only the default restore location is permitted (normally `/tmp/bacula-restores`). If `*all*` is specified any path the user enters will be accepted (not very secure), any other value specified (there may be multiple WhereACL directives) will restrict the user to use that path. For example, on a Unix system, if you specify `"/"`, the file will be restored to the original location. This directive is untested.

Aside from Director resource names and console command names, the special keyword `*all*` can be specified in any of the above access control lists. When this keyword is present, any resource or command name (which ever is appropriate) will be accepted. For an example configuration file, please see the Console Configuration chapter of this manual.

14.19 The Counter Resource

The Counter Resource defines a counter variable that can be accessed by variable expansion used for creating Volume labels with the **LabelFormat** directive. See the LabelFormat directive in this chapter for more details.

Counter Start of the Counter resource. Counter directives are optional.

Name = `<name>` The name of the Counter. This is the name you will use in the variable expansion to reference the counter value.



Minimum = <integer> This specifies the minimum value that the counter can have. It also becomes the default. If not supplied, zero is assumed.

Maximum = <integer> This is the maximum value value that the counter can have. If not specified or set to zero, the counter can have a maximum value of 2,147,483,648 (2 to the 31 power). When the counter is incremented past this value, it is reset to the Minimum.

***WrapCounter** = <counter-name> If this value is specified, when the counter is incremented past the maximum and thus reset to the minimum, the counter specified on the **WrapCounter** is incremented. (This is not currently implemented).

Catalog = <catalog-name> If this directive is specified, the counter and its values will be saved in the specified catalog. If this directive is not present, the counter will be redefined each time that Bacula is started.

14.20 Example Director Configuration File

An example Director configuration file might be the following:

```
#
# Default Bacula Director Configuration file
#
# The only thing that MUST be changed is to add one or more
# file or directory names in the Include directive of the
# FileSet resource.
#
# For Bacula release 1.15 (5 March 2002) -- redhat
#
# You might also want to change the default email address
# from root to your address. See the "mail" and "operator"
# directives in the Messages resource.
#
Director {
    # define myself
    Name = rufus-dir
    QueryFile = "/home/kern/bacula/bin/query.sql"
    WorkingDirectory = "/home/kern/bacula/bin/working"
    PidDirectory = "/home/kern/bacula/bin/working"
    Password = "XkSfzu/Cf/wX4L8Zh4G4/yhCbPLcz3YVdmVoQvU3EyF/"
}
# Define the backup Job
Job {
    Name = "NightlySave"
    Type = Backup
    Level = Incremental
    Client=rufus-fd
    FileSet="Full Set"
    Schedule = "WeeklyCycle"
    Storage = DLTDive
    Messages = Standard
    Pool = Default
}
Job {
    Name = "Restore"
    Type = Restore
    Client=rufus-fd
    FileSet="Full Set"
    Where = /tmp/bacula-restores
    Storage = DLTDive
    Messages = Standard
    Pool = Default
}

# List of files to be backed up
FileSet {
    Name = "Full Set"
    Include {
        Options {signature=SHA1}
    }
#
# Put your list of files here, one per line or include an
# external list with:
#
# @file-name
```



```
#
# Note: / backs up everything
File = /
}
Exclude {}
}
# When to do the backups
Schedule {
  Name = "WeeklyCycle"
  Run = level=Full sun at 2:05
  Run = level=Incremental mon-sat at 2:05
}
# Client (File Services) to backup
Client {
  Name = rufus-fd
  Address = rufus
  Catalog = MyCatalog
  Password = "MQk6lVinz4GG2hdIZk1dsKE/LxMZGo6znMHiD7t7vzF+"
  File Retention = 60d      # sixty day file retention
  Job Retention = 1y       # 1 year Job retention
  AutoPrune = yes         # Auto apply retention periods
}
# Definition of DLT tape storage device
Storage {
  Name = DLTDrive
  Address = rufus
  Password = "jMeWZvfikUHvt3kzKVVPpQOccmV6emPnF2cPYFdhLApQ"
  Device = "HP DLT 800"    # same as Device in Storage daemon
  Media Type = DLT8000    # same as MediaType in Storage daemon
}
# Definition for a DLT autochanger device
Storage {
  Name = Autochanger
  Address = rufus
  Password = "jMeWZvfikUHvt3kzKVVPpQOccmV6emPnF2cPYFdhLApQ"
  Device = "Autochanger"  # same as Device in Storage daemon
  Media Type = DLT-8000   # Different from DLTDrive
  Autochanger = yes
}
# Definition of DDS tape storage device
Storage {
  Name = SDT-10000
  Address = rufus
  Password = "jMeWZvfikUHvt3kzKVVPpQOccmV6emPnF2cPYFdhLApQ"
  Device = SDT-10000      # same as Device in Storage daemon
  Media Type = DDS-4      # same as MediaType in Storage daemon
}
# Definition of 8mm tape storage device
Storage {
  Name = "8mmDrive"
  Address = rufus
  Password = "jMeWZvfikUHvt3kzKVVPpQOccmV6emPnF2cPYFdhLApQ"
  Device = "Exabyte 8mm"
  MediaType = "8mm"
}
# Definition of file storage device
Storage {
  Name = File
  Address = rufus
  Password = "jMeWZvfikUHvt3kzKVVPpQOccmV6emPnF2cPYFdhLApQ"
  Device = FileStorage
  Media Type = File
}
# Generic catalog service
Catalog {
  Name = MyCatalog
  dbname = bacula; user = bacula; password = ""
}
# Reasonable message delivery -- send most everything to
# the email address and to the console
Messages {
  Name = Standard
  mail = root@localhost = all, !skipped, !terminate
  operator = root@localhost = mount
  console = all, !skipped, !saved
}
```



```
# Default pool definition
Pool {
  Name = Default
  Pool Type = Backup
  AutoPrune = yes
  Recycle = yes
}
#
# Restricted console used by tray-monitor to get the status of the director
#
Console {
  Name = Monitor
  Password = "GN0uRo7PTUmlMbqrJ2Gr1pOfk0HQJTxwnFyE4WSST3MWZseR"
  CommandACL = status, .status
}
```





Chapter 15

Client/File daemon Configuration

The Client (or File Daemon) Configuration is one of the simpler ones to specify. Generally, other than changing the Client name so that error messages are easily identified, you will not need to modify the default Client configuration file.

For a general discussion of configuration file and resources including the data types recognized by **Bacula**, please see the Configuration chapter of this manual. The following Client Resource definitions must be defined:

- **Client** – to define what Clients are to be backed up.
- **Director** – to define the Director's name and its access password.
- **Messages** – to define where error and information messages are to be sent.

15.1 The Client Resource

The Client Resource (or FileDaemon) resource defines the name of the Client (as used by the Director) as well as the port on which the Client listens for Director connections.

Client (or FileDaemon) Start of the Client records. There must be one and only one Client resource in the configuration file, since it defines the properties of the current client program.

Name = <name> The client name that must be used by the Director when connecting. Generally, it is a good idea to use a name related to the machine so that error messages can be easily identified if you have multiple Clients. This directive is required.

Working Directory = <Directory> This directive is mandatory and specifies a directory in which the File daemon may put its status files. This directory should be used only by **Bacula**, but may be shared by other Bacula daemons provided the daemon names on the **Name** definition are unique for each daemon. This directive is required.

On Win32 systems, in some circumstances you may need to specify a drive letter in the specified working directory path. Also, please be sure that this directory is writable by the SYSTEM user otherwise restores may fail (the bootstrap file that is transferred to the File daemon from the Director is temporarily put in this directory before being passed to the Storage daemon).

Pid Directory = <Directory> This directive is mandatory and specifies a directory in which the Director may put its process Id file files. The process Id file is used to shutdown Bacula and to prevent multiple copies of Bacula from running simultaneously. This record is required. Standard shell expansion of the **Directory** is done when the configuration file is read so that values such as **\$HOME** will be properly expanded.

Typically on Linux systems, you will set this to: **/var/run**. If you are not installing Bacula in the system directories, you can use the **Working Directory** as defined above.

Heartbeat Interval = <time-interval> This record defines an interval of time in seconds. For each heartbeat that the File daemon receives from the Storage daemon, it will forward it to the Director. In addition, if no heartbeat has been received from the Storage daemon and thus forwarded the File daemon will send a heartbeat signal to the Director and to the Storage daemon to keep the channels



active. The default interval is zero which disables the heartbeat. This feature is particularly useful if you have a router such as 3Com that does not follow Internet standards and times out a valid connection after a short duration despite the fact that keepalive is set. This usually results in a broken pipe error message.

If you continue getting broken pipe error messages despite using the Heartbeat Interval, and you are using Windows, you should consider upgrading your ethernet driver. This is a known problem with NVidia NForce 3 drivers (4.4.2 17/05/2004), or try the following workaround suggested by Thomas Simmons for Win32 machines:

Browse to: Start > Control Panel > Network Connections

Right click the connection for the nvidia adapter and select properties. Under the General tab, click "Configure...". Under the Advanced tab set "Checksum Offload" to disabled and click OK to save the change.

Lack of communications, or communications that get interrupted can also be caused by Linux firewalls where you have a rule that throttles connections or traffic.

Maximum Concurrent Jobs = <number> where <number> is the maximum number of Jobs that should run concurrently. The default is set to 2, but you may set it to a larger number. Each contact from the Director (e.g. status request, job start request) is considered as a Job, so if you want to be able to do a **status** request in the console at the same time as a Job is running, you will need to set this value greater than 1.

FDAddresses = <IP-address-specification> Specify the ports and addresses on which the File daemon listens for Director connections. Probably the simplest way to explain is to show an example:

```
FDAddresses = {
  ip = { addr = 1.2.3.4; port = 1205; }
  ipv4 = {
    addr = 1.2.3.4; port = http; }
  ipv6 = {
    addr = 1.2.3.4;
    port = 1205;
  }
  ip = {
    addr = 1.2.3.4
    port = 1205
  }
  ip = { addr = 1.2.3.4 }
  ip = {
    addr = 201:220:222::2
  }
  ip = {
    addr = bluedot.thun.net
  }
}
```

where ip, ipv4, ipv6, addr, and port are all keywords. Note, that the address can be specified as either a dotted quadruple, or IPv6 colon notation, or as a symbolic name (only in the ip specification). Also, port can be specified as a number or as the mnemonic value from the /etc/services file. If a port is not specified, the default will be used. If an ip section is specified, the resolution can be made either by IPv4 or IPv6. If ipv4 is specified, then only IPv4 resolutions will be permitted, and likewise with ipv6.

FDPort = <port-number> This specifies the port number on which the Client listens for Director connections. It must agree with the FDPort specified in the Client resource of the Director's configuration file. The default is 9102.

FDAddress = <IP-Address> This record is optional, and if it is specified, it will cause the File daemon server (for Director connections) to bind to the specified **IP-Address**, which is either a domain name or an IP address specified as a dotted quadruple. If this record is not specified, the File daemon will bind to any available address (the default).

FDSourceAddress = <IP-Address> This record is optional, and if it is specified, it will cause the File daemon server (for Storage connections) to bind to the specified **IP-Address**, which is either a domain name or an IP address specified as a dotted quadruple. If this record is not specified, the kernel will choose the best address according to the routing table (the default).

SDConnectTimeout = **<time-interval>** This record defines an interval of time that the File daemon will try to connect to the Storage daemon. The default is 30 minutes. If no connection is made in the specified time interval, the File daemon cancels the Job.

Maximum Network Buffer Size = **<bytes>** where **<bytes>** specifies the initial network buffer size to use with the File daemon. This size will be adjusted down if it is too large until it is accepted by the OS. Please use care in setting this value since if it is too large, it will be trimmed by 512 bytes until the OS is happy, which may require a large number of system calls. The default value is 65,536 bytes.

Note, on certain Windows machines, there are reports that the transfer rates are very slow and this seems to be related to the default 65,536 size. On systems where the transfer rates seem abnormally slow compared to other systems, you might try setting the Maximum Network Buffer Size to 32,768 in both the File daemon and in the Storage daemon.

Maximum Bandwidth Per Job = **<speed>** The speed parameter specifies the maximum allowed bandwidth that a job may use. The speed parameter should be specified in k/s, kb/s, m/s or mb/s.

Heartbeat Interval = **<time-interval>** This directive is optional and if specified will cause the File daemon to set a keepalive interval (heartbeat) in seconds on each of the sockets to communicate with the Storage daemon. It is implemented only on systems (Linux, ...) that provide the **setsockopt** TCP_KEEPIDLE function. The default value is zero, which means no change is made to the socket.

PKI Encryption See the Data Encryption chapter of this manual.

PKI Signatures See the Data Encryption chapter of this manual.

PKI Keypair See the Data Encryption chapter of this manual.

PKI Master Key See the Data Encryption chapter of this manual.

The following is an example of a valid Client resource definition:

```
Client {                                # this is me
  Name = rufus-fd
  WorkingDirectory = $HOME/bacula/bin/working
  Pid Directory = $HOME/bacula/bin/working
}
```

15.2 The Director Resource

The Director resource defines the name and password of the Directors that are permitted to contact this Client.

Director Start of the Director records. There may be any number of Director resources in the Client configuration file. Each one specifies a Director that is allowed to connect to this Client.

Name = **<name>** The name of the Director that may contact this Client. This name must be the same as the name specified on the Director resource in the Director's configuration file. Note, the case (upper/lower) of the characters in the name are significant (i.e. S is not the same as s). This directive is required.

Password = **<password>** Specifies the password that must be supplied for a Director to be authorized. This password must be the same as the password specified in the Client resource in the Director's configuration file. This directive is required.

Maximum Bandwidth Per Job = **<speed>** The speed parameter specifies the maximum allowed bandwidth that a job may use when started from this Director. The speed parameter should be specified in k/s, Kb/s, m/s or Mb/s.

Monitor = **<yes|no>** If Monitor is set to **no** (default), this director will have full access to this Client. If Monitor is set to **yes**, this director will only be able to fetch the current status of this Client.

Please note that if this director is being used by a Monitor, we highly recommend to set this directive to **yes** to avoid serious security problems.

Thus multiple Directors may be authorized to use this Client's services. Each Director will have a different name, and normally a different password as well.

The following is an example of a valid Director resource definition:



```
#
# List Directors who are permitted to contact the File daemon
#
Director {
    Name = HeadMan
    Password = very_good          # password HeadMan must supply
}
Director {
    Name = Worker
    Password = not_as_good
    Monitor = Yes
}
```

15.3 The Message Resource

Please see the Messages Resource Chapter of this manual for the details of the Messages Resource. There must be at least one Message resource in the Client configuration file.

15.4 Example Client Configuration File

An example File Daemon configuration file might be the following:

```
#
# Default Bacula File Daemon Configuration file
#
# For Bacula release 1.35.2 (16 August 2004) -- gentoo 1.4.16
#
# There is not much to change here except perhaps to
# set the Director's name and File daemon's name
# to something more appropriate for your site.
#
#
# List Directors who are permitted to contact this File daemon
#
Director {
    Name = rufus-dir
    Password = "/LqPRkX++saVyQE7w7mmiFg/qxYc1kufww6FEyY/47jU"
}
#
# Restricted Director, used by tray-monitor to get the
# status of the file daemon
#
Director {
    Name = rufus-mon
    Password = "FYpq4yyI1y562EMS35bA0J0QCOM2L3t5cZ0bxT3XQxgxpTn"
    Monitor = yes
}
#
# "Global" File daemon configuration specifications
#
FileDaemon {
    Name = rufus-fd          # this is me
    WorkingDirectory = $HOME/bacula/bin/working
    Pid Directory = $HOME/bacula/bin/working
}
# Send all messages except skipped files back to Director
Messages {
    Name = Standard
    director = rufus-dir = all, !skipped
}
}
```



Chapter 16

Storage Daemon Configuration

The Storage Daemon configuration file has relatively few resource definitions. However, due to the great variation in backup media and system capabilities, the storage daemon must be highly configurable. As a consequence, there are quite a large number of directives in the Device Resource definition that allow you to define all the characteristics of your Storage device (normally a tape drive). Fortunately, with modern storage devices, the defaults are sufficient, and very few directives are actually needed.

Examples of **Device** resource directives that are known to work for a number of common tape drives can be found in the `<bacula-src>/examples/devices` directory, and most will also be listed here.

For a general discussion of configuration file and resources including the data types recognized by **Bacula**, please see the Configuration chapter of this manual. The following Storage Resource definitions must be defined:

- **Storage** – to define the name of the Storage daemon.
- **Director** – to define the Director's name and his access password.
- **Device** – to define the characteristics of your storage device (tape drive).
- **Messages** – to define where error and information messages are to be sent.

16.1 Storage Resource

In general, the properties specified under the Storage resource define global properties of the Storage daemon. Each Storage daemon configuration file must have one and only one Storage resource definition.

Name = `<Storage-Daemon-Name>` Specifies the Name of the Storage daemon. This directive is required.

Working Directory = `<Directory>` This directive is mandatory and specifies a directory in which the Storage daemon may put its status files. This directory should be used only by **Bacula**, but may be shared by other Bacula daemons provided the names given to each daemon are unique. This directive is required

Pid Directory = `<Directory>` This directive is mandatory and specifies a directory in which the Director may put its process Id file files. The process Id file is used to shutdown Bacula and to prevent multiple copies of Bacula from running simultaneously. This directive is required. Standard shell expansion of the **Directory** is done when the configuration file is read so that values such as **\$HOME** will be properly expanded.

Typically on Linux systems, you will set this to: `/var/run`. If you are not installing Bacula in the system directories, you can use the **Working Directory** as defined above.

Heartbeat Interval = `<time-interval>` This directive defines an interval of time in seconds. When the Storage daemon is waiting for the operator to mount a tape, each time interval, it will send a heartbeat signal to the File daemon. The default interval is zero which disables the heartbeat. This feature is particularly useful if you have a router such as 3Com that does not follow Internet standards and times out an valid connection after a short duration despite the fact that keepalive is set. This usually results in a broken pipe error message.



Client Connect Wait = **<time-interval>** This directive defines an interval of time in seconds that the Storage daemon will wait for a Client (the File daemon) to connect. The default is 30 minutes. Be aware that the longer the Storage daemon waits for a Client, the more resources will be tied up.

Maximum Concurrent Jobs = **<number>** where **<number>** is the maximum number of Jobs that may run concurrently. The default is set to 10, but you may set it to a larger number. Each contact from the Director (e.g. status request, job start request) is considered as a Job, so if you want to be able to do a **status** request in the console at the same time as a Job is running, you will need to set this value greater than 1. To run simultaneous Jobs, you will need to set a number of other directives in the Director's configuration file. Which ones you set depend on what you want, but you will almost certainly need to set the **Maximum Concurrent Jobs** in the Storage resource in the Director's configuration file and possibly those in the Job and Client resources.

SDAddresses = **<IP-address-specification>** Specify the ports and addresses on which the Storage daemon will listen for Director connections. Normally, the default is sufficient and you do not need to specify this directive. Probably the simplest way to explain how this directive works is to show an example:

```
SDAddresses = { ip = {
    addr = 1.2.3.4; port = 1205; }
  ipv4 = {
    addr = 1.2.3.4; port = http; }
  ipv6 = {
    addr = 1.2.3.4;
    port = 1205;
  }
  ip = {
    addr = 1.2.3.4
    port = 1205
  }
  ip = {
    addr = 1.2.3.4
  }
  ip = {
    addr = 201:220:222::2
  }
  ip = {
    addr = bluedot.thun.net
  }
}
```

where ip, ip4, ip6, addr, and port are all keywords. Note, that the address can be specified as either a dotted quadruple, or IPv6 colon notation, or as a symbolic name (only in the ip specification). Also, port can be specified as a number or as the mnemonic value from the `/etc/services` file. If a port is not specified, the default will be used. If an ip section is specified, the resolution can be made either by IPv4 or IPv6. If ip4 is specified, then only IPv4 resolutions will be permitted, and likewise with ip6.

Using this directive, you can replace both the SDPort and SDAddress directives shown below.

SDPort = **<port-number>** Specifies port number on which the Storage daemon listens for Director connections. The default is 9103.

SDAddress = **<IP-Address>** This directive is optional, and if it is specified, it will cause the Storage daemon server (for Director and File daemon connections) to bind to the specified **IP-Address**, which is either a domain name or an IP address specified as a dotted quadruple. If this directive is not specified, the Storage daemon will bind to any available address (the default).

The following is a typical Storage daemon Storage definition.

```
#
# "Global" Storage daemon configuration specifications appear
# under the Storage resource.
#
Storage {
  Name = "Storage daemon"
  Address = localhost
  WorkingDirectory = "~/bacula/working"
  Pid Directory = "~/bacula/working"
}
```



16.2 Director Resource

The Director resource specifies the Name of the Director which is permitted to use the services of the Storage daemon. There may be multiple Director resources. The Director Name and Password must match the corresponding values in the Director's configuration file.

Name = <Director-Name> Specifies the Name of the Director allowed to connect to the Storage daemon. This directive is required.

Password = <Director-password> Specifies the password that must be supplied by the above named Director. This directive is required.

Monitor = <yes|no> If Monitor is set to **no** (default), this director will have full access to this Storage daemon. If Monitor is set to **yes**, this director will only be able to fetch the current status of this Storage daemon.

Please note that if this director is being used by a Monitor, we highly recommend to set this directive to **yes** to avoid serious security problems.

The following is an example of a valid Director resource definition:

```
Director {
  Name = MainDirector
  Password = my_secret_password
}
```

16.3 Device Resource

The Device Resource specifies the details of each device (normally a tape drive) that can be used by the Storage daemon. There may be multiple Device resources for a single Storage daemon. In general, the properties specified within the Device resource are specific to the Device.

Name = *Device-Name* Specifies the Name that the Director will use when asking to backup or restore to or from to this device. This is the logical Device name, and may be any string up to 127 characters in length. It is generally a good idea to make it correspond to the English name of the backup device. The physical name of the device is specified on the **Archive Device** directive described below. The name you specify here is also used in your Director's conf file on the Device directive in its Storage resource.

Archive Device = *name-string* The specified **name-string** gives the system file name of the storage device managed by this storage daemon. This will usually be the device file name of a removable storage device (tape drive), for example **/dev/nst0** or **/dev/rmt/0mbn**. It may also be a directory name if you are archiving to disk storage. In this case, you must supply the full absolute path to the directory. When specifying a tape device, it is preferable that the "non-rewind" variant of the device file name be given. In addition, on systems such as Sun, which have multiple tape access methods, you must be sure to specify to use Berkeley I/O conventions with the device. The **b** in the Solaris (Sun) archive specification **/dev/rmt/0mbn** is what is needed in this case. Bacula does not support SysV tape drive behavior.

As noted above, normally the Archive Device is the name of a tape drive, but you may also specify an absolute path to an existing directory. If the Device is a directory Bacula will write to file storage in the specified directory, and the filename used will be the Volume name as specified in the Catalog. If you want to write into more than one directory (i.e. to spread the load to different disk drives), you will need to define two Device resources, each containing an Archive Device with a different directory. In addition to a tape device name or a directory name, Bacula will accept the name of a FIFO. A FIFO is a special kind of file that connects two programs via kernel memory. If a FIFO device is specified for a backup operation, you must have a program that reads what Bacula writes into the FIFO. When the Storage daemon starts the job, it will wait for **MaximumOpenWait** seconds for the read program to start reading, and then time it out and terminate the job. As a consequence, it is best to start the read program at the beginning of the job perhaps with the **RunBeforeJob** directive. For this kind of device, you never want to specify **AlwaysOpen**, because you want the Storage daemon to open it only when a job starts, so you must explicitly set it to **No**. Since a FIFO is a one way device, Bacula will not attempt to read a label of a FIFO device, but will simply write on it. To create a FIFO Volume in the catalog, use the **add** command rather than the **label** command to avoid attempting to write a label.



```
Device {
  Name = FifoStorage
  Media Type = Fifo
  Device Type = Fifo
  Archive Device = /tmp/fifo
  LabelMedia = yes
  Random Access = no
  AutomaticMount = no
  RemovableMedia = no
  MaximumOpenWait = 60
  AlwaysOpen = no
}
```

During a restore operation, if the Archive Device is a FIFO, Bacula will attempt to read from the FIFO, so you must have an external program that writes into the FIFO. Bacula will wait **MaximumOpenWait** seconds for the program to begin writing and will then time it out and terminate the job. As noted above, you may use the **RunBeforeJob** to start the writer program at the beginning of the job.

The Archive Device directive is required.

Device Type = *type-specification* The Device Type specification allows you to explicitly tell Bacula what kind of device you are defining. It the *type-specification* may be one of the following:

File Tells Bacula that the device is a file. It may either be a file defined on fixed medium or a removable filesystem such as USB. All files must be random access devices.

Tape The device is a tape device and thus is sequential access. Tape devices are controlled using `ioctl()` calls.

Fifo The device is a first-in-first out sequential access read-only or write-only device.

The Device Type directive is not required, and if not specified, Bacula will attempt to guess what kind of device has been specified using the Archive Device specification supplied. There are several advantages to explicitly specifying the Device Type. First, on some systems, block and character devices have the same type. Secondly, if you explicitly specify the Device Type, the mount point need not be defined until the device is opened. This is the case with most removable devices such as USB that are mounted by the HAL daemon. If the Device Type is not explicitly specified, then the mount point must exist when the Storage daemon starts.

This directive was implemented in Bacula version 1.38.6.

Media Type = *name-string* The specified **name-string** names the type of media supported by this device, for example, "DLT7000". Media type names are arbitrary in that you set them to anything you want, but they must be known to the volume database to keep track of which storage daemons can read which volumes. In general, each different storage type should have a unique Media Type associated with it. The same **name-string** must appear in the appropriate Storage resource definition in the Director's configuration file.

Even though the names you assign are arbitrary (i.e. you choose the name you want), you should take care in specifying them because the Media Type is used to determine which storage device Bacula will select during restore. Thus you should probably use the same Media Type specification for all drives where the Media can be freely interchanged. This is not generally an issue if you have a single Storage daemon, but it is with multiple Storage daemons, especially if they have incompatible media.

For example, if you specify a Media Type of "DDS-4" then during the restore, Bacula will be able to choose any Storage Daemon that handles "DDS-4". If you have an autochanger, you might want to name the Media Type in a way that is unique to the autochanger, unless you wish to possibly use the Volumes in other drives. You should also ensure to have unique Media Type names if the Media is not compatible between drives. This specification is required for all devices.

In addition, if you are using disk storage, each Device resource will generally have a different mount point or directory. In order for Bacula to select the correct Device resource, each one must have a unique Media Type.

Autochanger = *yes|no* If **Yes**, this device belongs to an automatic tape changer, and you must specify an **Autochanger** resource that points to the **Device** resources. You must also specify a **Changer Device**. If the Autochanger directive is set to **No** (default), the volume must be manually changed. You should also have an identical directive to the Storage resource in the Director's configuration file so that when labeling tapes you are prompted for the slot.



Changer Device = *name-string* The specified **name-string** must be the **generic SCSI** device name of the autochanger that corresponds to the normal read/write **Archive Device** specified in the Device resource. This generic SCSI device name should be specified if you have an autochanger or if you have a standard tape drive and want to use the **Alert Command** (see below). For example, on Linux systems, for an Archive Device name of `/dev/nst0`, you would specify `/dev/sg0` for the Changer Device name. Depending on your exact configuration, and the number of autochangers or the type of autochanger, what you specify here can vary. This directive is optional. See the Using Autochangers chapter of this manual for more details of using this and the following autochanger directives.

Changer Command = *name-string* The **name-string** specifies an external program to be called that will automatically change volumes as required by **Bacula**. Normally, this directive will be specified only in the **AutoChanger** resource, which is then used for all devices. However, you may also specify the different **Changer Command** in each Device resource. Most frequently, you will specify the Bacula supplied **mtx-changer** script as follows:

```
Changer Command = "/path/mtx-changer %c %o %S %a %d"
```

and you will install the **mtx** on your system (found in the **depkgs** release). An example of this command is in the default `bacula-sd.conf` file. For more details on the substitution characters that may be specified to configure your autochanger please see the Autochangers chapter of this manual. For FreeBSD users, you might want to see one of the several **chio** scripts in **examples/autochangers**.

Alert Command = *name-string* The **name-string** specifies an external program to be called at the completion of each Job after the device is released. The purpose of this command is to check for Tape Alerts, which are present when something is wrong with your tape drive (at least for most modern tape drives). The same substitution characters that may be specified in the Changer Command may also be used in this string. For more information, please see the Autochangers chapter of this manual.

Note, it is not necessary to have an autochanger to use this command. The example below uses the **tapeinfo** program that comes with the **mtx** package, but it can be used on any tape drive. However, you will need to specify a **Changer Device** directive in your Device resource (see above) so that the generic SCSI device name can be edited into the command (with the `%c`).

An example of the use of this command to print Tape Alerts in the Job report is:

```
Alert Command = "sh -c 'tapeinfo -f %c | grep TapeAlert'"
```

and an example output when there is a problem could be:

```
bacula-sd Alert: TapeAlert[32]: Interface: Problem with SCSI interface
                between tape drive and initiator.
```

Drive Index = *number* The **Drive Index** that you specify is passed to the **mtx-changer** script and is thus passed to the **mtx** program. By default, the Drive Index is zero, so if you have only one drive in your autochanger, everything will work normally. However, if you have multiple drives, you must specify multiple Bacula Device resources (one for each drive). The first Device should have the Drive Index set to 0, and the second Device Resource should contain a Drive Index set to 1, and so on. This will then permit you to use two or more drives in your autochanger. As of Bacula version 1.38.0, using the **Autochanger** resource, Bacula will automatically ensure that only one drive at a time uses the autochanger script, so you no longer need locking scripts as in the past – the default `mtx-changer` script works for any number of drives.

Autoselect = *yes|no* If this directive is set to **yes** (default), and the Device belongs to an autochanger, then when the Autochanger is referenced by the Director, this device can automatically be selected. If this directive is set to **no**, then the Device can only be referenced by directly using the Device name in the Director. This is useful for reserving a drive for something special such as a high priority backup or restore operations.

Maximum Concurrent Jobs = *num* **Maximum Concurrent Jobs** is a directive that permits setting the maximum number of Jobs that can run concurrently on a specified Device. Using this directive, it is possible to have different Jobs using multiple drives, because when the Maximum Concurrent Jobs limit is reached, the Storage Daemon will start new Jobs on any other available compatible drive. This facilitates writing to multiple drives with multiple Jobs that all use the same Pool.



Maximum Changer Wait = *time* This directive specifies the maximum time in seconds for Bacula to wait for an autochanger to change the volume. If this time is exceeded, Bacula will invalidate the Volume slot number stored in the catalog and try again. If no additional changer volumes exist, Bacula will ask the operator to intervene. The default is 5 minutes.

Maximum Rewind Wait = *time* This directive specifies the maximum time in seconds for Bacula to wait for a rewind before timing out. If this time is exceeded, Bacula will cancel the job. The default is 5 minutes.

Maximum Open Wait = *time* This directive specifies the maximum time in seconds that Bacula will wait for a device that is busy. The default is 5 minutes. If the device cannot be obtained, the current Job will be terminated in error. Bacula will re-attempt to open the drive the next time a Job starts that needs the the drive.

Always Open = *yes|no* If **Yes** (default), Bacula will always keep the device open unless specifically **unmounted** by the Console program. This permits Bacula to ensure that the tape drive is always available, and properly positioned. If you set **AlwaysOpen** to **no**, Bacula will only open the drive when necessary, and at the end of the Job if no other Jobs are using the drive, it will be freed. The next time Bacula wants to append to a tape on a drive that was freed, Bacula will rewind the tape and position it to the end. To avoid unnecessary tape positioning and to minimize unnecessary operator intervention, it is highly recommended that **Always Open** = **yes**. This also ensures that the drive is available when Bacula needs it.

If you have **Always Open** = **yes** (recommended) and you want to use the drive for something else, simply use the **unmount** command in the Console program to release the drive. However, don't forget to remount the drive with **mount** when the drive is available or the next Bacula job will block.

For File storage, this directive is ignored. For a FIFO storage device, you must set this to **No**.

Please note that if you set this directive to **No** Bacula will release the tape drive between each job, and thus the next job will rewind the tape and position it to the end of the data. This can be a very time consuming operation. In addition, with this directive set to no, certain multiple drive autochanger operations will fail. We strongly recommend to keep **Always Open** set to **Yes**

Volume Poll Interval = *time* If the time specified on this directive is non-zero, after asking the operator to mount a new volume Bacula will periodically poll (or read) the drive at the specified interval to see if a new volume has been mounted. If the time interval is zero (the default), no polling will occur. This directive can be useful if you want to avoid operator intervention via the console. Instead, the operator can simply remove the old volume and insert the requested one, and Bacula on the next poll will recognize the new tape and continue. Please be aware that if you set this interval too small, you may excessively wear your tape drive if the old tape remains in the drive, since Bacula will read it on each poll. This can be avoided by ejecting the tape using the **Offline On Unmount** and the **Close on Poll** directives. However, if you are using a Linux 2.6 kernel or other OSes such as FreeBSD or Solaris, the Offline On Unmount will leave the drive with no tape, and Bacula will not be able to properly open the drive and may fail the job. For more information on this problem, please see the **description of Offline On Unmount** subsection (subsection 3.1 on page 32) in the **Tape Testing** chapter (chapter 3 on page 31) of the Bacula Community Problem Resolution Guide.

Close on Poll= *yes|no* If **Yes**, Bacula close the device (equivalent to an unmount except no mount is required) and reopen it at each poll. Normally this is not too useful unless you have the **Offline on Unmount** directive set, in which case the drive will be taken offline preventing wear on the tape during any future polling. Once the operator inserts a new tape, Bacula will recognize the drive on the next poll and automatically continue with the backup. Please see above more more details.

Removable media = *yes|no* If **Yes**, this device supports removable media (for example, tapes or CDs). If **No**, media cannot be removed (for example, an intermediate backup area on a hard disk). If **Removable media** is enabled on a File device (as opposed to a tape) the Storage daemon will assume that device may be something like a USB device that can be removed or a simply a removable harddisk. When attempting to open such a device, if the Volume is not found (for File devices, the Volume name is the same as the Filename), then the Storage daemon will search the entire device looking for likely Volume names, and for each one found, it will ask the Director if the Volume can be used. If so, the Storage daemon will use the first such Volume found. Thus it acts somewhat like a tape drive – if the correct Volume is not found, it looks at what actually is found, and if it is an appendable Volume, it will use it.



If the removable medium is not automatically mounted (e.g. udev), then you might consider using additional Storage daemon device directives such as **Requires Mount**, **Mount Point**, **Mount Command**, and **Unmount Command**, all of which can be used in conjunction with **Removable Media**.

Random access = *yes|no* If **Yes**, the archive device is assumed to be a random access medium which supports the **lseek** (or **lseek64** if Largefile is enabled during configuration) facility. This should be set to **Yes** for all file systems such as USB, and fixed files. It should be set to **No** for non-random access devices such as tapes and named pipes.

Requires Mount = *yes|no* When this directive is enabled, the Storage daemon will submit a **Mount Command** before attempting to open the device. You must set this directive to **yes** for removable file systems such as USB devices that are not automatically mounted by the operating system when plugged in or opened by Bacula. It should be set to **no** for all other devices such as tapes and fixed filesystems. It should also be set to **no** for any removable device that is automatically mounted by the operating system when opened (e.g. USB devices mounted by udev or hotplug). This directive indicates if the device requires to be mounted using the **Mount Command**. To be able to write devices need a mount, the following directives must also be defined: **Mount Point**, **Mount Command**, and **Unmount Command**.

Mount Point = *directory* Directory where the device can be mounted. This directive is used only for devices that have **Requires Mount** enabled such as USB file devices.

Mount Command = *name-string* This directive specifies the command that must be executed to mount devices such as many USB devices. Before the command is executed, %a is replaced with the Archive Device, and %m with the Mount Point.

See the Edit Codes section below for more details of the editing codes that can be used in this directive.

If you need to specify multiple commands, create a shell script.

Unmount Command = *name-string* This directive specifies the command that must be executed to unmount devices such as many USB devices. Before the command is executed, %a is replaced with the Archive Device, and %m with the Mount Point.

Most frequently, you will define it as follows:

```
Unmount Command = "/bin/umount %m"
```

See the Edit Codes section below for more details of the editing codes that can be used in this directive.

If you need to specify multiple commands, create a shell script.

Block Checksum = *yes|no* You may turn off the Block Checksum (CRC32) code that Bacula uses when writing blocks to a Volume. Doing so can reduce the Storage daemon CPU usage slightly. It will also permit Bacula to read a Volume that has corrupted data.

The default is **yes** – i.e. the checksum is computed on write and checked on read.

We do not recommend to turn this off particularly on older tape drives or for disk Volumes where doing so may allow corrupted data to go undetected.

Minimum block size = *size-in-bytes* On most modern tape drives, you will not need or want to specify this directive, and if you do so, it will be to make Bacula use fixed block sizes. This statement applies only to non-random access devices (e.g. tape drives). Blocks written by the storage daemon to a non-random archive device will never be smaller than the given **size-in-bytes**. The Storage daemon will attempt to efficiently fill blocks with data received from active sessions but will, if necessary, add padding to a block to achieve the required minimum size.

To force the block size to be fixed, as is the case for some non-random access devices (tape drives), set the **Minimum block size** and the **Maximum block size** to the same value (zero included). The default is that both the minimum and maximum block size are zero and the default block size is 64,512 bytes.

For example, suppose you want a fixed block size of 100K bytes, then you would specify:

```
Minimum block size = 100K
Maximum block size = 100K
```



Please note that if you specify a fixed block size as shown above, the tape drive must either be in variable block size mode, or if it is in fixed block size mode, the block size (generally defined by **mt**) **must** be identical to the size specified in Bacula – otherwise when you attempt to re-read your Volumes, you will get an error.

If you want the block size to be variable but with a 64K minimum and 200K maximum (and default as well), you would specify:

```
Minimum block size = 64K
Maximum blocksize = 200K
```

Maximum block size = *size-in-bytes* On most modern tape drives, you will not need to specify this directive. If you do so, it will most likely be to use fixed block sizes (see Minimum block size above). The Storage daemon will always attempt to write blocks of the specified **size-in-bytes** to the archive device. As a consequence, this statement specifies both the default block size and the maximum block size. The size written never exceed the given **size-in-bytes**. If adding data to a block would cause it to exceed the given maximum size, the block will be written to the archive device, and the new data will begin a new block.

If no value is specified or zero is specified, the Storage daemon will use a default block size of 64,512 bytes (126 * 512).

The maximum **size-in-bytes** possible is 2,000,000.

Hardware End of Medium = *yes|no* If **No**, the archive device is not required to support end of medium `ioctl` request, and the storage daemon will use the forward space file function to find the end of the recorded data. If **Yes**, the archive device must support the `ioctl` MTEOM call, which will position the tape to the end of the recorded data. In addition, your SCSI driver must keep track of the file number on the tape and report it back correctly by the `MTIOCGGET` `ioctl`. Note, some SCSI drivers will correctly forward space to the end of the recorded data, but they do not keep track of the file number. On Linux machines, the SCSI driver has a **fast-eod** option, which if set will cause the driver to lose track of the file number. You should ensure that this option is always turned off using the **mt** program.

Default setting for Hardware End of Medium is **Yes**. This function is used before appending to a tape to ensure that no previously written data is lost. We recommend if you have a non-standard or unusual tape drive that you use the **btape** program to test your drive to see whether or not it supports this function. All modern (after 1998) tape drives support this feature.

Fast Forward Space File = *yes|no* If **No**, the archive device is not required to support keeping track of the file number (`MTIOCGGET` `ioctl`) during forward space file. If **Yes**, the archive device must support the `ioctl` MTFSF call, which virtually all drivers support, but in addition, your SCSI driver must keep track of the file number on the tape and report it back correctly by the `MTIOCGGET` `ioctl`. Note, some SCSI drivers will correctly forward space, but they do not keep track of the file number or more seriously, they do not report end of medium.

Default setting for Fast Forward Space File is **Yes**.

Use MTIOCGGET = *yes|no* If **No**, the operating system is not required to support keeping track of the file number and reporting it in the (`MTIOCGGET` `ioctl`). The default is **Yes**. If you must set this to No, Bacula will do the proper file position determination, but it is very unfortunate because it means that tape movement is very inefficient. Fortunately, this operation system deficiency seems to be the case only on a few *BSD systems. Operating systems known to work correctly are Solaris, Linux and FreeBSD.

BSF at EOM = *yes|no* If **No**, the default, no special action is taken by Bacula with the End of Medium (end of tape) is reached because the tape will be positioned after the last EOF tape mark, and Bacula can append to the tape as desired. However, on some systems, such as FreeBSD, when Bacula reads the End of Medium (end of tape), the tape will be positioned after the second EOF tape mark (two successive EOF marks indicated End of Medium). If Bacula appends from that point, all the appended data will be lost. The solution for such systems is to specify **BSF at EOM** which causes Bacula to backspace over the second EOF mark. Determination of whether or not you need this directive is done using the **test** command in the **btape** program.



TWO EOF = *yes|no* If **Yes**, Bacula will write two end of file marks when terminating a tape – i.e. after the last job or at the end of the medium. If **No**, the default, Bacula will only write one end of file to terminate the tape.

Backward Space Record = *yes|no* If *Yes*, the archive device supports the **MTBSR ioctl** to backspace records. If *No*, this call is not used and the device must be rewound and advanced forward to the desired position. Default is **Yes** for non random-access devices. This function if enabled is used at the end of a Volume after writing the end of file and any ANSI/IBM labels to determine whether or not the last block was written correctly. If you turn this function off, the test will not be done. This causes no harm as the re-read process is precautionary rather than required.

Backward Space File = *yes|no* If *Yes*, the archive device supports the **MTBSF** and **MTBSF ioctls** to backspace over an end of file mark and to the start of a file. If *No*, these calls are not used and the device must be rewound and advanced forward to the desired position. Default is **Yes** for non random-access devices.

Forward Space Record = *yes|no* If *Yes*, the archive device must support the **MTFSR ioctl** to forward space over records. If **No**, data must be read in order to advance the position on the device. Default is **Yes** for non random-access devices.

Forward Space File = *yes|no* If **Yes**, the archive device must support the **MTFSF ioctl** to forward space by file marks. If *No*, data must be read to advance the position on the device. Default is **Yes** for non random-access devices.

Offline On Unmount = *yes|no* The default for this directive is **No**. If **Yes** the archive device must support the **MTOFFL ioctl** to rewind and take the volume offline. In this case, Bacula will issue the offline (eject) request before closing the device during the **unmount** command. If **No** Bacula will not attempt to offline the device before unmounting it. After an offline is issued, the cassette will be ejected thus **requiring operator intervention** to continue, and on some systems require an explicit load command to be issued (**mt -f /dev/xxx load**) before the system will recognize the tape. If you are using an autochanger, some devices require an offline to be issued prior to changing the volume. However, most devices do not and may get very confused.

If you are using a Linux 2.6 kernel or other OSes such as FreeBSD or Solaris, the Offline On Unmount will leave the drive with no tape, and Bacula will not be able to properly open the drive and may fail the job. For more information on this problem, please see the **description of Offline On Unmount** subsection (subsection 3.1 on page 32) in the **Tape Testing** chapter (chapter 3 on page 31) of the Bacula Community Problem Resolution Guide.

Maximum Concurrent Jobs = *<number>* where *<number>* is the maximum number of Jobs that can run concurrently on a specified Device. Using this directive, it is possible to have different Jobs using multiple drives, because when the Maximum Concurrent Jobs limit is reached, the Storage Daemon will start new Jobs on any other available compatible drive. This facilitates writing to multiple drives with multiple Jobs that all use the same Pool.

Maximum Volume Size = *size* No more than *size* bytes will be written onto a given volume on the archive device. This directive is used mainly in testing Bacula to simulate a small Volume. It can also be useful if you wish to limit the size of a File Volume to say less than 2GB of data. In some rare cases of really antiquated tape drives that do not properly indicate when the end of a tape is reached during writing (though I have read about such drives, I have never personally encountered one). Please note, this directive is deprecated (being phased out) in favor of the **Maximum Volume Bytes** defined in the Director's configuration file.

Maximum File Size = *size* No more than *size* bytes will be written into a given logical file on the volume. Once this size is reached, an end of file mark is written on the volume and subsequent data are written into the next file. Breaking long sequences of data blocks with file marks permits quicker positioning to the start of a given stream of data and can improve recovery from read errors on the volume. The default is one Gigabyte. This directive creates EOF marks only on tape media. However, regardless of the medium type (tape, disk, USB ...) each time a the Maximum File Size is exceeded, a record is put into the catalog database that permits seeking to that position on the medium for restore operations. If you set this to a small value (e.g. 1MB), you will generate lots of database records (JobMedia) and may significantly increase CPU/disk overhead.

If you are configuring an LTO-3 or LTO-4 tape, you probably will want to set the **Maximum File Size** to 2GB to avoid making the drive stop to write an EOF mark.



Note, this directive does not limit the size of Volumes that Bacula will create regardless of whether they are tape or disk volumes. It changes only the number of EOF marks on a tape and the number of block positioning records (see below) that are generated. If you want to limit the size of all Volumes for a particular device, use the **Maximum Volume Size** directive (above), or use the **Maximum Volume Bytes** directive in the Director's Pool resource, which does the same thing but on a Pool (Volume) basis.

Block Positioning = *yes|no* This directive tells Bacula not to use block positioning when doing restores. Turning this directive off can cause Bacula to be **extremely** slow when restoring files. You might use this directive if you wrote your tapes with Bacula in variable block mode (the default), but your drive was in fixed block mode. The default is **yes**.

Maximum Network Buffer Size = *bytes* where *bytes* specifies the initial network buffer size to use with the File daemon. This size will be adjusted down if it is too large until it is accepted by the OS. Please use care in setting this value since if it is too large, it will be trimmed by 512 bytes until the OS is happy, which may require a large number of system calls. The default value is 32,768 bytes.

The default size was chosen to be relatively large but not too big in the case that you are transmitting data over Internet. It is clear that on a high speed local network, you can increase this number and improve performance. For example, some users have found that if you use a value of 65,536 bytes they get five to ten times the throughput. Larger values for most users don't seem to improve performance. If you are interested in improving your backup speeds, this is definitely a place to experiment. You will probably also want to make the corresponding change in each of your File daemons conf files.

Maximum Spool Size = *bytes* where the bytes specify the maximum spool size for all jobs that are running. The default is no limit.

Maximum Job Spool Size = *bytes* where the bytes specify the maximum spool size for any one job that is running. The default is no limit. This directive is implemented only in version 1.37 and later.

Spool Directory = *directory* specifies the name of the directory to be used to store the spool files for this device. This directory is also used to store temporary part files when writing to a device that requires mount (USB). The default is to use the working directory.

16.4 Edit Codes for Mount and Unmount Directives

Before submitting the **Mount Command**, **Unmount Command**, or **Free Space Command** directives to the operating system, Bacula performs character substitution of the following characters:

```
%% = %
%a = Archive device name
%e = erase (set if cannot mount and first part)
%n = part number
%m = mount point
```

16.5 Devices that require a mount (USB)

All the directives in this section are implemented only in Bacula version 1.37 and later and hence are available in version 1.38.6.

The directives: "Requires Mount", "Mount Point", "Mount Command", and "Unmount Command" apply to removable filesystems such as USB.

Requires Mount = *yes|no* You must set this directive to **yes** for removable devices such as USB unless they are automounted, and to **no** for all other devices (tapes/files). This directive indicates if the device requires to be mounted to be read, and if it must be written in a special way. If it set, **Mount Point**, **Mount Command**, and **Unmount Command** directives must also be defined.

Mount Point = *directory* Directory where the device can be mounted.

Mount Command = *name-string* Command that must be executed to mount the device. Before the command is executed, %a is replaced with the Archive Device, and %m with the Mount Point.

Most frequently, you will define it as follows:



```
Mount Command = "/bin/mount -t iso9660 -o ro %a %m"
```

For some media, you may need multiple commands. If so, it is recommended that you use a shell script instead of putting them all into the Mount Command. For example, instead of this:

```
Mount Command = "/usr/local/bin/mymount"
```

Where that script contains:

```
#!/bin/sh
ndasadmin enable -s 1 -o w
sleep 2
mount /dev/ndas-00323794-0p1 /backup
```

Similar consideration should be given to all other Command parameters.

Unmount Command = *name-string* Command that must be executed to unmount the device. Before the command is executed, %a is replaced with the Archive Device, and %m with the Mount Point.

Most frequently, you will define it as follows:

```
Unmount Command = "/bin/umount %m"
```

If you need to specify multiple commands, create a shell script.





Chapter 17

Autochanger Resource

The Autochanger resource supports single or multiple drive autochangers by grouping one or more Device resources into one unit called an autochanger in Bacula (often referred to as a "tape library" by autochanger manufacturers).

If you have an Autochanger, and you want it to function correctly, you **must** have an Autochanger resource in your Storage conf file, and your Director's Storage directives that want to use an Autochanger **must** refer to the Autochanger resource name. In previous versions of Bacula, the Director's Storage directives referred directly to Device resources that were autochangers. In version 1.38.0 and later, referring directly to Device resources will not work for Autochangers.

Name = <**Autochanger-Name**> Specifies the Name of the Autochanger. This name is used in the Director's Storage definition to refer to the autochanger. This directive is required.

Device = <**Device-name1, device-name2, ...**> Specifies the names of the Device resource or resources that correspond to the autochanger drive. If you have a multiple drive autochanger, you must specify multiple Device names, each one referring to a separate Device resource that contains a Drive Index specification that corresponds to the drive number base zero. You may specify multiple device names on a single line separated by commas, and/or you may specify multiple Device directives. This directive is required.

Changer Device = *name-string* The specified **name-string** gives the system file name of the autochanger device name. If specified in this resource, the Changer Device name is not needed in the Device resource. If it is specified in the Device resource (see above), it will take precedence over one specified in the Autochanger resource.

Changer Command = *name-string* The **name-string** specifies an external program to be called that will automatically change volumes as required by **Bacula**. Most frequently, you will specify the Bacula supplied **mtx-changer** script as follows. If it is specified here, it need not be specified in the Device resource. If it is also specified in the Device resource, it will take precedence over the one specified in the Autochanger resource.

The following is an example of a valid Autochanger resource definition:

```
Autochanger {
    Name = "DDS-4-changer"
    Device = DDS-4-1, DDS-4-2, DDS-4-3
    Changer Device = /dev/sg0
    Changer Command = "/etc/bacula/mtx-changer %c %o %S %a %d"
}
Device {
    Name = "DDS-4-1"
    Drive Index = 0
    Autochanger = yes
    ...
}
Device {
    Name = "DDS-4-2"
    Drive Index = 1
    Autochanger = yes
    ...
}
Device {
    Name = "DDS-4-3"
```



```

Drive Index = 2
Autochanger = yes
Autoselect = no
...
}

```

Please note that it is important to include the **Autochanger = yes** directive in each Device definition that belongs to an Autochanger. A device definition should not belong to more than one Autochanger resource. Also, your Device directive in the Storage resource of the Director's conf file should have the Autochanger's resource name rather than a name of one of the Devices.

If you have a drive that physically belongs to an Autochanger but you don't want to have it automatically used when Bacula references the Autochanger for backups, for example, you want to reserve it for restores, you can add the directive:

```
Autoselect = no
```

to the Device resource for that drive. In that case, Bacula will not automatically select that drive when accessing the Autochanger. You can, still use the drive by referencing it by the Device name directly rather than the Autochanger name. An example of such a definition is shown above for the Device DDS-4-3, which will not be selected when the name DDS-4-changer is used in a Storage definition, but will be used if DDS-4-3 is used.

17.1 Capabilities

Label Media = yes|no If **Yes**, permits this device to automatically label blank media without an explicit operator command. It does so by using an internal algorithm as defined on the Label Format record in each Pool resource. If this is **No** as by default, Bacula will label tapes only by specific operator command (**label** in the Console) or when the tape has been recycled. The automatic labeling feature is most useful when writing to disk rather than tape volumes.

Automatic mount = yes|no If **Yes** (the default), permits the daemon to examine the device to determine if it contains a Bacula labeled volume. This is done initially when the daemon is started, and then at the beginning of each job. This directive is particularly important if you have set **Always Open = no** because it permits Bacula to attempt to read the device before asking the system operator to mount a tape. However, please note that the tape must be mounted before the job begins.

17.2 Messages Resource

For a description of the Messages Resource, please see the Messages Resource Chapter of this manual.

17.3 Sample Storage Daemon Configuration File

An example Storage Daemon configuration file might be the following:

```

#
# Default Bacula Storage Daemon Configuration file
#
# For Bacula release 1.37.2 (07 July 2005) -- gentoo 1.4.16
#
# You may need to change the name of your tape drive
# on the "Archive Device" directive in the Device
# resource. If you change the Name and/or the
# "Media Type" in the Device resource, please ensure
# that bacula-dir.conf has corresponding changes.
#
Storage {                                # definition of myself
    Name = rufus-sd
    Address = rufus
    WorkingDirectory = "$HOME/bacula/bin/working"
    Pid Directory = "$HOME/bacula/bin/working"
    Maximum Concurrent Jobs = 20
}
#
# List Directors who are permitted to contact Storage daemon
#

```



```

Director {
  Name = rufus-dir
  Password = "ZF9Ctf5PQoWCPkmR3s4atCB0usUPg+vWwYIo2VS5ti6k"
}
#
# Restricted Director, used by tray-monitor to get the
# status of the storage daemon
#
Director {
  Name = rufus-mon
  Password = "9usxgc307dMbe7jbd16v0PX1hd64UVasIDD0DH2WAujcDsc6"
  Monitor = yes
}
#
# Devices supported by this Storage daemon
# To connect, the Director's bacula-dir.conf must have the
# same Name and MediaType.
#
Autochanger {
  Name = Autochanger
  Device = Drive-1
  Device = Drive-2
  Changer Command = "/home/kern/bacula/bin/mtx-changer %c %o %S %a %d"
  Changer Device = /dev/sg0
}

Device {
  Name = Drive-1
  Drive Index = 0
  Media Type = DLT-8000
  Archive Device = /dev/nst0
  AutomaticMount = yes; # when device opened, read it
  AlwaysOpen = yes;
  RemovableMedia = yes;
  RandomAccess = no;
  AutoChanger = yes
  Alert Command = "sh -c 'tapeinfo -f %c |grep TapeAlert|cat'"
}

Device {
  Name = Drive-2
  Drive Index = 1
  Media Type = DLT-8000
  Archive Device = /dev/nst1
  AutomaticMount = yes; # when device opened, read it
  AlwaysOpen = yes;
  RemovableMedia = yes;
  RandomAccess = no;
  AutoChanger = yes
  Alert Command = "sh -c 'tapeinfo -f %c |grep TapeAlert|cat'"
}

Device {
  Name = "HP DLT 80"
  Media Type = DLT8000
  Archive Device = /dev/nst0
  AutomaticMount = yes; # when device opened, read it
  AlwaysOpen = yes;
  RemovableMedia = yes;
}
#Device {
# Name = SDT-7000
# Media Type = DDS-2
# Archive Device = /dev/nst0
# AutomaticMount = yes; # when device opened, read it
# AlwaysOpen = yes;
# RemovableMedia = yes;
#}
#Device {
# Name = Floppy
# Media Type = Floppy
# Archive Device = /mnt/floppy
# RemovableMedia = yes;
# Random Access = Yes;
# AutomaticMount = yes; # when device opened, read it
# AlwaysOpen = no;
}

```



```
#}
#Device {
# Name = FileStorage
# Media Type = File
# Archive Device = /tmp
# LabelMedia = yes;                # lets Bacula label unlabeled media
# Random Access = Yes;
# AutomaticMount = yes;           # when device opened, read it
# RemovableMedia = no;
# AlwaysOpen = no;
#}
#
# A very old Exabyte with no end of media detection
#
#Device {
# Name = "Exabyte 8mm"
# Media Type = "8mm"
# Archive Device = /dev/nst0
# Hardware end of medium = No;
# AutomaticMount = yes;           # when device opened, read it
# AlwaysOpen = Yes;
# RemovableMedia = yes;
#}
#
# Send all messages to the Director,
# mount messages also are sent to the email address
#
Messages {
  Name = Standard
  director = rufus-dir = all
  operator = root = mount
}
```



Chapter 18

Messages Resource

The Messages resource defines how messages are to be handled and destinations to which they should be sent.

Even though each daemon has a full message handler, within the File daemon and the Storage daemon, you will normally choose to send all the appropriate messages back to the Director. This permits all the messages associated with a single Job to be combined in the Director and sent as a single email message to the user, or logged together in a single file.

Each message that Bacula generates (i.e. that each daemon generates) has an associated type such as INFO, WARNING, ERROR, FATAL, etc. Using the message resource, you can specify which message types you wish to see and where they should be sent. In addition, a message may be sent to multiple destinations. For example, you may want all error messages both logged as well as sent to you in an email. By defining multiple messages resources, you can have different message handling for each type of Job (e.g. Full backups versus Incremental backups).

In general, messages are attached to a Job and are included in the Job report. There are some rare cases, where this is not possible, e.g. when no job is running, or if a communications error occurs between a daemon and the director. In those cases, the message may remain in the system, and should be flushed at the end of the next Job. However, since such messages are not attached to a Job, any that are mailed will be sent to `/usr/lib/sendmail`. On some systems, such as FreeBSD, if your sendmail is in a different place, you may want to link it to the the above location.

The records contained in a Messages resource consist of a **destination** specification followed by a list of **message-types** in the format:

```
destination = message-type1, message-type2, message-type3, ...
```

or for those destinations that need an address specification (e.g. email):

```
destination = address = message-type1, message-type2, message-type3, ...
```

Where **destination** is one of a predefined set of keywords that define where the message is to be sent (**stdout**, **file**, ...), **message-type** is one of a predefined set of keywords that define the type of message generated by Bacula (**ERROR**, **WARNING**, **FATAL**, ...), and **address** varies according to the **destination** keyword, but is typically an email address or a filename.

The following are the list of the possible record definitions that can be used in a message resource.

Messages Start of the Messages records.

Name = `<name>` The name of the Messages resource. The name you specify here will be used to tie this Messages resource to a Job and/or to the daemon.

MailCommand = `<command>` In the absence of this resource, Bacula will send all mail using the following command:

```
mail -s "Bacula Message" <recipients>
```

In many cases, depending on your machine, this command may not work. However, by using the **Mail-Command**, you can specify exactly how to send the mail. During the processing of the **command** part, normally specified as a quoted string, the following substitutions will be used:



```

%% = %
%b = Job Bytes
%c = Client's name
%d = Daemon's name (Such as host-dir or host-fd)
%D = Director's name (Also valid on file daemon)
%e = Job Exit Status
%f = Job FileSet (Only on director side)
%F = Job Files
%h = Client address
%i = JobId
%j = Unique Job id
%l = Job Level
%n = Job name
%p = Pool name (Only on director side)
%P = Current PID process
%r = Recipients
%s = Since time
%t = Job type (Backup, ...)
%v = Volume name (Only on director side)
%w = Storage name (Only on director side)
%x = Spooling enabled? ("yes" or "no")

```

Please note: any **MailCommand** directive must be specified in the **Messages** resource **before** the desired **Mail**, **MailOnSuccess**, or **MailOnError** directive. In fact, each of those directives may be preceded by a different **MailCommand**.

The following is an exampl. Note, the whole command should appear on a single line in the configuration file rather than split as is done here for presentation:

```
mailcommand = "/home/kern/bacula/bin/bsmtp -h mail.example.com -f \"\ (Bacula\)\
%r\" -s \"Bacula: %t %e of %c %l\" %r"
```

The **bsmtp** program is provided as part of **Bacula**. For additional details, please see the **bsmtp – Customizing Your Email Messages** section (section 1.11 on page 15) of the Bacula Utility Programs chapter of this manual. Please test any **mailcommand** that you use to ensure that your bsmtp gateway accepts the addressing form that you use. Certain programs such as Exim can be very selective as to what forms are permitted particularly in the from part.

OperatorCommand = <command> This resource specification is similar to the **MailCommand** except that it is used for Operator messages. The substitutions performed for the **MailCommand** are also done for this command. Normally, you will set this command to the same value as specified for the **MailCommand**. The **OperatorCommand** directive must appear in the **Messages** resource before the **Operator** directive.

<destination> = <message-type1>, <message-type2>, ... Where **destination** may be one of the following:

stdout Send the message to standard output.

stderr Send the message to standard error.

console Send the message to the console (Bacula Console). These messages are held until the console program connects to the Director.

<destination> = <address> = <message-type1>, <message-type2>, ...

Where **address** depends on the **destination**.

The **destination** may be one of the following:

director Send the message to the Director whose name is given in the **address** field. Note, in the current implementation, the Director Name is ignored, and the message is sent to the Director that started the Job.

file Send the message to the filename given in the **address** field. If the file already exists, it will be overwritten.



append Append the message to the filename given in the **address** field. If the file already exists, it will be appended to. If the file does not exist, it will be created.

syslog Send the message to the system log (syslog) using the facility specified in the **address** field. Note, for the moment, the **address** field is ignored and the message is always sent to the LOG_DAEMON facility with level LOG_ERR. See **man 3 syslog** for more details. Example:

```
syslog = all, !skipped
```

Although the **syslog** destination is not used in the default Bacula config files, in certain cases where Bacula encounters errors in trying to deliver a message, as a last resort, it will send it to the system **syslog** to prevent loss of the message, so you might occasionally check the **syslog** for Bacula output (normally `/var/log/syslog`).

mail Send the message to the email addresses that are given as a comma separated list in the **address** field. Mail messages are grouped together during a job and then sent as a single email message when the job terminates. The advantage of this destination is that you are notified about every Job that runs. However, if you backup five or ten machines every night, the volume of email messages can be important. Some users use filter programs such as **procmail** to automatically file this email based on the Job termination code (see **mailcommand**).

mail on error Send the message to the email addresses that are given as a comma separated list in the **address** field if the Job terminates with an error condition. MailOnError messages are grouped together during a job and then sent as a single email message when the job terminates. This destination differs from the **mail** destination in that if the Job terminates normally, the message is totally discarded (for this destination). If the Job terminates in error, it is emailed. By using other destinations such as **append** you can ensure that even if the Job terminates normally, the output information is saved.

mail on success Send the message to the email addresses that are given as a comma separated list in the **address** field if the Job terminates normally (no error condition). MailOnSuccess messages are grouped together during a job and then sent as a single email message when the job terminates. This destination differs from the **mail** destination in that if the Job terminates abnormally, the message is totally discarded (for this destination). If the Job terminates normally, it is emailed.

operator Send the message to the email addresses that are specified as a comma separated list in the **address** field. This is similar to **mail** above, except that each message is sent as received. Thus there is one email per message. This is most useful for **mount** messages (see below).

console Send the message to the Bacula console.

stdout Send the message to the standard output (normally not used).

stderr Send the message to the standard error output (normally not used).

catalog Send the message to the Catalog database. The message will be written to the table named **Log** and a timestamp field will also be added. This permits Job Reports and other messages to be recorded in the Catalog so that they can be accessed by reporting software. Bacula will prune the Log records associated with a Job when the Job records are pruned. Otherwise, Bacula never uses these records internally, so this destination is only used for special purpose programs (e.g. **bweb**).

For any destination, the **message-type** field is a comma separated list of the following types or classes of messages:

info General information messages.

warning Warning messages. Generally this is some unusual condition but not expected to be serious.

error Non-fatal error messages. The job continues running. Any error message should be investigated as it means that something went wrong.

fatal Fatal error messages. Fatal errors cause the job to terminate.

terminate Message generated when the daemon shuts down.

notsaved Files not saved because of some error. Usually because the file cannot be accessed (i.e. it does not exist or is not mounted).



skipped Files that were skipped because of a user supplied option such as an incremental backup or a file that matches an exclusion pattern. This is not considered an error condition such as the files listed for the **notsaved** type because the configuration file explicitly requests these types of files to be skipped. For example, any unchanged file during an incremental backup, or any subdirectory if the no recursion option is specified.

mount Volume mount or intervention requests from the Storage daemon. These requests require a specific operator intervention for the job to continue.

restored The **ls** style listing generated for each file restored is sent to this message class.

all All message types.

security Security info/warning messages principally from unauthorized connection attempts.

alert Alert messages. These are messages generated by tape alerts.

volmgmt Volume management messages. Currently there are no volume management messages generated.

The following is an example of a valid Messages resource definition, where all messages except files explicitly skipped or daemon termination messages are sent by email to enforcement@sec.com. In addition all mount messages are sent to the operator (i.e. emailed to enforcement@sec.com). Finally all messages other than explicitly skipped files and files saved are sent to the console:

```
Messages {
  Name = Standard
  mail = enforcement@sec.com = all, !skipped, !terminate
  operator = enforcement@sec.com = mount
  console = all, !skipped, !saved
}
```

With the exception of the email address (changed to avoid junk mail from robot's), an example Director's Messages resource is as follows. Note, the **mailcommand** and **operatorcommand** are on a single line – they had to be split for this manual:

```
Messages {
  Name = Standard
  mailcommand = "bacula/bin/bsmtp -h mail.example.com \
  -f \"\Bacula\" %r\" -s \"Bacula: %t %e of %c %l\" %r"
  operatorcommand = "bacula/bin/bsmtp -h mail.example.com \
  -f \"\Bacula\" %r\" -s \"Bacula: Intervention needed \
  for %j\" %r"
  MailOnError = security@example.com = all, !skipped, \
  !terminate
  append = "bacula/bin/log" = all, !skipped, !terminate
  operator = security@example.com = mount
  console = all, !skipped, !saved
}
```



Chapter 19

Console Configuration

19.1 General

The Console configuration file is the simplest of all the configuration files, and in general, you should not need to change it except for the password. It simply contains the information necessary to contact the Director or Directors.

For a general discussion of the syntax of configuration files and their resources including the data types recognized by **Bacula**, please see the Configuration chapter of this manual.

The following Console Resource definition must be defined:

19.2 The Director Resource

The Director resource defines the attributes of the Director running on the network. You may have multiple Director resource specifications in a single Console configuration file. If you have more than one, you will be prompted to choose one when you start the **Console** program.

Director Start of the Director directives.

Name = <name> The director name used to select among different Directors, otherwise, this name is not used.

DIRPort = <port-number> Specify the port to use to connect to the Director. This value will most likely already be set to the value you specified on the **--with-baseport** option of the **./configure** command. This port must be identical to the **DIRport** specified in the **Director** resource of the Director's configuration file. The default is 9101 so this directive is not normally specified.

Address = <address> Where the address is a host name, a fully qualified domain name, or a network address used to connect to the Director.

Password = <password> Where the password is the password needed for the Director to accept the Console connection. This password must be identical to the **Password** specified in the **Director** resource of the Director's configuration file. This directive is required.

An actual example might be:

```
Director {
  Name = HeadMan
  address = rufus.cats.com
  password = xyz1erpl0it
}
```

19.3 The ConsoleFont Resource

The ConsoleFont resource is available only in the GNOME version of the console. It permits you to define the font that you want used to display in the main listing window.

ConsoleFont Start of the ConsoleFont directives.

Name = <name> The name of the font.



Font = <Pango Font Name> The string value given here defines the desired font. It is specified in the Pango format. For example, the default specification is:

```
Font = "LucidaTypewriter 9"
```

Thanks to Phil Stracchino for providing the code for this feature.
An different example might be:

```
ConsoleFont {  
    Name = Default  
    Font = "Monospace 10"  
}
```

19.4 The Console Resource

There are three different kinds of consoles, which the administrator or user can use to interact with the Director. These three kinds of consoles comprise three different security levels.

- The first console type is an **anonymous** or **default** console, which has full privileges. There is no console resource necessary for this type since the password is specified in the Director resource. Typically you would use this **anonymous** console only for administrators.
- The second type of console is a "named" or "restricted" console defined within a Console resource in both the Director's configuration file and in the Console's configuration file. Both the names and the passwords in these two entries must match much as is the case for Client programs.

This second type of console begins with absolutely no privileges except those explicitly specified in the Director's Console resource. Note, the definition of what these restricted consoles can do is determined by the Director's conf file.

Thus you may define within the Director's conf file multiple Consoles with different names and passwords, sort of like multiple users, each with different privileges. As a default, these consoles can do absolutely nothing – no commands what so ever. You give them privileges or rather access to commands and resources by specifying access control lists in the Director's Console resource. This gives the administrator fine grained control over what particular consoles (or users) can do.

- The third type of console is similar to the above mentioned restricted console in that it requires a Console resource definition in both the Director and the Console. In addition, if the console name, provided on the **Name** = directive, is the same as a Client name, the user of that console is permitted to use the **SetIP** command to change the Address directive in the Director's client resource to the IP address of the Console. This permits portables or other machines using DHCP (non-fixed IP addresses) to "notify" the Director of their current IP address.

The Console resource is optional and need not be specified. However, if it is specified, you can use ACLs (Access Control Lists) in the Director's configuration file to restrict the particular console (or user) to see only information pertaining to his jobs or client machine.

You may specify as many Console resources in the console's conf file. If you do so, generally the first Console resource will be used. However, if you have multiple Director resources (i.e. you want to connect to different directors), you can bind one of your Console resources to a particular Director resource, and thus when you choose a particular Director, the appropriate Console configuration resource will be used. See the "Director" directive in the Console resource described below for more information.

Note, the Console resource is optional, but can be useful for restricted consoles as noted above.

Console Start of the Console resource.

Name = <name> The Console name used to allow a restricted console to change its IP address using the SetIP command. The SetIP command must also be defined in the Director's conf CommandACL list.

Password = <password> If this password is supplied, then the password specified in the Director resource of you Console conf will be ignored. See below for more details.

Director = <director-resource-name> If this directive is specified, this Console resource will be used by bconsole when that particular director is selected when first starting bconsole. I.e. it binds a particular console resource with its name and password to a particular director.



Heartbeat Interval = <time-interval> This directive is optional and if specified will cause the Console to set a keepalive interval (heartbeat) in seconds on each of the sockets to communicate with the Director. It is implemented only on systems (Linux, ...) that provide the **setsockopt** TCP_KEEPIIDLE function. The default value is zero, which means no change is made to the socket.

The following configuration files were supplied by Phil Stracchino. For example, if we define the following in the user's bconsole.conf file (or perhaps the bwx-console.conf file):

```
Director {
  Name = MyDirector
  DIRport = 9101
  Address = myserver
  Password = "XXXXXXXXXX" # no, really. this is not obfuscation.
}

Console {
  Name = restricted-user
  Password = "UntrustedUser"
}
```

Where the Password in the Director section is deliberately incorrect, and the Console resource is given a name, in this case **restricted-user**. Then in the Director's bacula-dir.conf file (not directly accessible by the user), we define:

```
Console {
  Name = restricted-user
  Password = "UntrustedUser"
  JobACL = "Restricted Client Save"
  ClientACL = restricted-client
  StorageACL = main-storage
  ScheduleACL = *all*
  PoolACL = *all*
  FileSetACL = "Restricted Client's FileSet"
  CatalogACL = DefaultCatalog
  CommandACL = run
}
```

the user logging into the Director from his Console will get logged in as **restricted-user**, and he will only be able to see or access a Job with the name **Restricted Client Save** a Client with the name **restricted-client**, a Storage device **main-storage**, any Schedule or Pool, a FileSet named **Restricted Client's FileSet**, a Catalog named **DefaultCatalog**, and the only command he can use in the Console is the **run** command. In other words, this user is rather limited in what he can see and do with Bacula.

The following is an example of a bconsole conf file that can access several Directors and has different Consoles depending on the director:

```
Director {
  Name = MyDirector
  DIRport = 9101
  Address = myserver
  Password = "XXXXXXXXXX" # no, really. this is not obfuscation.
}

Director {
  Name = SecondDirector
  DIRport = 9101
  Address = secondserver
  Password = "XXXXXXXXXX" # no, really. this is not obfuscation.
}

Console {
  Name = restricted-user
  Password = "UntrustedUser"
  Director = MyDirector
}

Console {
  Name = restricted-user
  Password = "A different UntrustedUser"
  Director = SecondDirector
}
```



The second Director referenced at "secondserver" might look like the following:

```
Console {
  Name = restricted-user
  Password = "A different UntrustedUser"
  JobACL = "Restricted Client Save"
  ClientACL = restricted-client
  StorageACL = second-storage
  ScheduleACL = *all*
  PoolACL = *all*
  FileSetACL = "Restricted Client's FileSet"
  CatalogACL = RestrictedCatalog
  CommandACL = run, restore
  WhereACL = "/"
}
```

19.5 Console Commands

For more details on running the console and its commands, please see the **Bacula Console** chapter (chapter 1 on page 1) of the Bacula Community Console Manual.

19.6 Sample Console Configuration File

An example Console configuration file might be the following:

```
#
# Bacula Console Configuration File
#
Director {
  Name = HeadMan
  address = "my_machine.my_domain.com"
  Password = Console_password
}
```



Chapter 20

Monitor Configuration

The Monitor configuration file is a stripped down version of the Director configuration file, mixed with a Console configuration file. It simply contains the information necessary to contact Directors, Clients, and Storage daemons you want to monitor.

For a general discussion of configuration file and resources including the data types recognized by **Bacula**, please see the Configuration chapter of this manual.

The following Monitor Resource definition must be defined:

- **Monitor** – to define the Monitor’s name used to connect to all the daemons and the password used to connect to the Directors. Note, you must not define more than one Monitor resource in the Monitor configuration file.
- At least one Client, Storage or Director resource, to define the daemons to monitor.

20.1 The Monitor Resource

The Monitor resource defines the attributes of the Monitor running on the network. The parameters you define here must be configured as a Director resource in Clients and Storages configuration files, and as a Console resource in Directors configuration files.

Monitor Start of the Monitor records.

Name = <name> Specify the Director name used to connect to Client and Storage, and the Console name used to connect to Director. This record is required.

Password = <password> Where the password is the password needed for Directors to accept the Console connection. This password must be identical to the **Password** specified in the **Console** resource of the Director’s configuration file. This record is required if you wish to monitor Directors.

Refresh Interval = <time> Specifies the time to wait between status requests to each daemon. It can’t be set to less than 1 second, or more than 10 minutes, and the default value is 5 seconds.

20.2 The Director Resource

The Director resource defines the attributes of the Directors that are monitored by this Monitor.

As you are not permitted to define a Password in this resource, to avoid obtaining full Director privileges, you must create a Console resource in the Director’s configuration file, using the Console Name and Password defined in the Monitor resource. To avoid security problems, you should configure this Console resource to allow access to no other daemons, and permit the use of only two commands: **status** and **.status** (see below for an example).

You may have multiple Director resource specifications in a single Monitor configuration file.

Director Start of the Director records.

Name = <name> The Director name used to identify the Director in the list of monitored daemons. It is not required to be the same as the one defined in the Director’s configuration file. This record is required.



DIRPort = <port-number> Specify the port to use to connect to the Director. This value will most likely already be set to the value you specified on the **--with-baseport** option of the **./configure** command. This port must be identical to the **DIRport** specified in the **Director** resource of the Director's configuration file. The default is 9101 so this record is not normally specified.

Address = <address> Where the address is a host name, a fully qualified domain name, or a network address used to connect to the Director. This record is required.

20.3 The Client Resource

The Client resource defines the attributes of the Clients that are monitored by this Monitor.

You must create a Director resource in the Client's configuration file, using the Director Name defined in the Monitor resource. To avoid security problems, you should set the **Monitor** directive to **Yes** in this Director resource.

You may have multiple Director resource specifications in a single Monitor configuration file.

Client (or FileDaemon) Start of the Client records.

Name = <name> The Client name used to identify the Director in the list of monitored daemons. It is not required to be the same as the one defined in the Client's configuration file. This record is required.

Address = <address> Where the address is a host name, a fully qualified domain name, or a network address in dotted quad notation for a Bacula File daemon. This record is required.

FD Port = <port-number> Where the port is a port number at which the Bacula File daemon can be contacted. The default is 9102.

Password = <password> This is the password to be used when establishing a connection with the File services, so the Client configuration file on the machine to be backed up must have the same password defined for this Director. This record is required.

20.4 The Storage Resource

The Storage resource defines the attributes of the Storages that are monitored by this Monitor.

You must create a Director resource in the Storage's configuration file, using the Director Name defined in the Monitor resource. To avoid security problems, you should set the **Monitor** directive to **Yes** in this Director resource.

You may have multiple Director resource specifications in a single Monitor configuration file.

Storage Start of the Storage records.

Name = <name> The Storage name used to identify the Director in the list of monitored daemons. It is not required to be the same as the one defined in the Storage's configuration file. This record is required.

Address = <address> Where the address is a host name, a fully qualified domain name, or a network address in dotted quad notation for a Bacula Storage daemon. This record is required.

SD Port = <port> Where port is the port to use to contact the storage daemon for information and to start jobs. This same port number must appear in the Storage resource of the Storage daemon's configuration file. The default is 9103.

Password = <password> This is the password to be used when establishing a connection with the Storage services. This same password also must appear in the Director resource of the Storage daemon's configuration file. This record is required.



20.5 Tray Monitor Security

There is no security problem in relaxing the permissions on tray-monitor.conf as long as FD, SD and DIR are configured properly, so the passwords contained in this file only gives access to the status of the daemons. It could be a security problem if you consider the status information as potentially dangerous (I don't think it is the case).

Concerning Director's configuration:

In tray-monitor.conf, the password in the Monitor resource must point to a restricted console in bacula-dir.conf (see the documentation). So, if you use this password with bconsole, you'll only have access to the status of the director (commands status and .status). It could be a security problem if there is a bug in the ACL code of the director.

Concerning File and Storage Daemons' configuration:

In tray-monitor.conf, the Name in the Monitor resource must point to a Director resource in bacula-fd/sd.conf, with the Monitor directive set to Yes (once again, see the documentation). It could be a security problem if there is a bug in the code which check if a command is valid for a Monitor (this is very unlikely as the code is pretty simple).

20.6 Sample Tray Monitor configuration

An example Tray Monitor configuration file might be the following:

```
#
# Bacula Tray Monitor Configuration File
#
Monitor {
  Name = rufus-mon          # password for Directors
  Password = "GN0uRo7PTUmlMbqrJ2Gr1p0fk0HQJTxwnFyE4WSST3MWZseR"
  RefreshInterval = 10 seconds
}

Client {
  Name = rufus-fd
  Address = rufus
  FDPort = 9102             # password for FileDaemon
  Password = "FYpq4yyI1y562EMS35bA0J0QCOM2L3t5cZ0bxT3XQxgxpTn"
}

Storage {
  Name = rufus-sd
  Address = rufus
  SDPort = 9103            # password for StorageDaemon
  Password = "9usxgc307dMbe7jbd16v0PX1hd64UVasIDD0DH2WAujcDsc6"
}

Director {
  Name = rufus-dir
  DIRport = 9101
  address = rufus
}
```

20.6.1 Sample File daemon's Director record.

[Click here to see the full example.](#)

```
#
# Restricted Director, used by tray-monitor to get the
# status of the file daemon
#
Director {
  Name = rufus-mon
  Password = "FYpq4yyI1y562EMS35bA0J0QCOM2L3t5cZ0bxT3XQxgxpTn"
  Monitor = yes
}
```

20.6.2 Sample Storage daemon's Director record.

[Click here to see the full example.](#)

```
#
# Restricted Director, used by tray-monitor to get the
```



```
# status of the storage daemon
#
Director {
  Name = rufus-mon
  Password = "9usxgc307dMbe7jbD16v0PX1hd64UVasIDD0DH2WAujcDsc6"
  Monitor = yes
}
```

20.6.3 Sample Director's Console record.

[Click here to see the full example.](#)

```
#
# Restricted console used by tray-monitor to get the status of the director
#
Console {
  Name = Monitor
  Password = "GN0uRo7PTUmlMbqrJ2Grip0fk0HQJTxwnFyE4WSST3MWZseR"
  CommandACL = status, .status
}
```



Chapter 21

The Restore Command

21.1 General

Below, we will discuss restoring files with the Console **restore** command, which is the recommended way of doing restoring files. It is not possible to restore files by automatically starting a job as you do with Backup, Verify, ... jobs. However, in addition to the console restore command, there is a standalone program named **bextract**, which also permits restoring files. For more information on this program, please see the **bextract** command (command 1.6 on page 6) in the Bacula Community Utility programs. We don't particularly recommend the **bextract** program because it lacks many of the features of the normal Bacula restore, such as the ability to restore Win32 files to Unix systems, and the ability to restore access control lists (ACL). As a consequence, we recommend, wherever possible to use Bacula itself for restores as described below.

You may also want to look at the **bls** program in the same chapter, which allows you to list the contents of your Volumes. Finally, if you have an old Volume that is no longer in the catalog, you can restore the catalog entries using the program named **bscan**, documented in the same **bscan** command (command 1.7 on page 8) in the Bacula Community Utility programs.

In general, to restore a file or a set of files, you must run a **restore** job. That is a job with **Type = Restore**. As a consequence, you will need a predefined **restore** job in your **bacula-dir.conf** (Director's config) file. The exact parameters (Client, FileSet, ...) that you define are not important as you can either modify them manually before running the job or if you use the **restore** command, explained below, Bacula will automatically set them for you. In fact, you can no longer simply run a restore job. You must use the restore command.

Since Bacula is a network backup program, you must be aware that when you restore files, it is up to you to ensure that you or Bacula have selected the correct Client and the correct hard disk location for restoring those files. **Bacula** will quite willingly backup client A, and restore it by sending the files to a different directory on client B. Normally, you will want to avoid this, but assuming the operating systems are not too different in their file structures, this should work perfectly well, if so desired. By default, Bacula will restore data to the same Client that was backed up, and those data will be restored not to the original places but to **/tmp/bacula-restores**. You may modify any of these defaults when the restore command prompts you to run the job by selecting the **mod** option.

21.2 The Restore Command

Since Bacula maintains a catalog of your files and on which Volumes (disk or tape), they are stored, it can do most of the bookkeeping work, allowing you simply to specify what kind of restore you want (current, before a particular date), and what files to restore. Bacula will then do the rest.

This is accomplished using the **restore** command in the Console. First you select the kind of restore you want, then the JobIds are selected, the File records for those Jobs are placed in an internal Bacula directory tree, and the restore enters a file selection mode that allows you to interactively walk up and down the file tree selecting individual files to be restored. This mode is somewhat similar to the standard Unix **restore** program's interactive file selection mode.

If a Job's file records have been pruned from the catalog, the **restore** command will be unable to find any files to restore. Bacula will ask if you want to restore all of them or if you want to use a regular expression to restore only a selection while reading media. See FileRegex option and below for more details on this.



Within the Console program, after entering the **restore** command, you are presented with the following selection prompt:

```
First you select one or more JobIds that contain files
to be restored. You will be presented several methods
of specifying the JobIds. Then you will be allowed to
select which files from those JobIds are to be restored.
To select the JobIds, you have the following choices:
  1: List last 20 Jobs run
  2: List Jobs where a given File is saved
  3: Enter list of comma separated JobIds to select
  4: Enter SQL list command
  5: Select the most recent backup for a client
  6: Select backup for a client before a specified time
  7: Enter a list of files to restore
  8: Enter a list of files to restore before a specified time
  9: Find the JobIds of the most recent backup for a client
 10: Find the JobIds for a backup for a client before a specified time
 11: Enter a list of directories to restore for found JobIds
 12: Cancel
Select item: (1-12):
```

There are a lot of options, and as a point of reference, most people will want to select item 5 (the most recent backup for a client). The details of the above options are:

- Item 1 will list the last 20 jobs run. If you find the Job you want, you can then select item 3 and enter its JobId(s).
- Item 2 will list all the Jobs where a specified file is saved. If you find the Job you want, you can then select item 3 and enter the JobId.
- Item 3 allows you to enter a list of comma separated JobIds whose files will be put into the directory tree. You may then select which files from those JobIds to restore. Normally, you would use this option if you have a particular version of a file that you want to restore and you know its JobId. The most common options (5 and 6) will not select a job that did not terminate normally, so if you know a file is backed up by a Job that failed (possibly because of a system crash), you can access it through this option by specifying the JobId.
- Item 4 allows you to enter any arbitrary SQL command. This is probably the most primitive way of finding the desired JobIds, but at the same time, the most flexible. Once you have found the JobId(s), you can select item 3 and enter them.
- Item 5 will automatically select the most recent Full backup and all subsequent incremental and differential backups for a specified Client. These are the Jobs and Files which, if reloaded, will restore your system to the most current saved state. It automatically enters the JobIds found into the directory tree in an optimal way such that only the most recent copy of any particular file found in the set of Jobs will be restored. This is probably the most convenient of all the above options to use if you wish to restore a selected Client to its most recent state.

There are two important things to note. First, this automatic selection will never select a job that failed (terminated with an error status). If you have such a job and want to recover one or more files from it, you will need to explicitly enter the JobId in item 3, then choose the files to restore.

If some of the Jobs that are needed to do the restore have had their File records pruned, the restore will be incomplete. Bacula currently does not correctly detect this condition. You can however, check for this by looking carefully at the list of Jobs that Bacula selects and prints. If you find Jobs with the JobFiles column set to zero, when files should have been backed up, then you should expect problems.

If all the File records have been pruned, Bacula will realize that there are no file records in any of the JobIds chosen and will inform you. It will then propose doing a full restore (non-selective) of those JobIds. This is possible because Bacula still knows where the beginning of the Job data is on the Volumes, even if it does not know where particular files are located or what their names are.

- Item 6 allows you to specify a date and time, after which Bacula will automatically select the most recent Full backup and all subsequent incremental and differential backups that started before the specified date and time.



- Item 7 allows you to specify one or more filenames (complete path required) to be restored. Each filename is entered one at a time or if you prefix a filename with the less-than symbol (<) Bacula will read that file and assume it is a list of filenames to be restored. If you prefix the filename with a question mark (?), then the filename will be interpreted as an SQL table name, and Bacula will include the rows of that table in the list to be restored. The table must contain the JobId in the first column and the FileIndex in the second column. This table feature is intended for external programs that want to build their own list of files to be restored. The filename entry mode is terminated by entering a blank line.
- Item 8 allows you to specify a date and time before entering the filenames. See Item 7 above for more details.
- Item 9 allows you find the JobIds of the most recent backup for a client. This is much like option 5 (it uses the same code), but those JobIds are retained internally as if you had entered them manually. You may then select item 11 (see below) to restore one or more directories.
- Item 10 is the same as item 9, except that it allows you to enter a before date (as with item 6). These JobIds will then be retained internally.
- Item 11 allows you to enter a list of JobIds from which you can select directories to be restored. The list of JobIds can have been previously created by using either item 9 or 10 on the menu. You may then enter a full path to a directory name or a filename preceded by a less than sign (<). The filename should contain a list of directories to be restored. All files in those directories will be restored, but if the directory contains subdirectories, nothing will be restored in the subdirectory unless you explicitly enter its name.
- Item 12 allows you to cancel the restore command.

As an example, suppose that we select item 5 (restore to most recent state). If you have not specified a client=xxx on the command line, it will then ask for the desired Client, which on my system, will print all the Clients found in the database as follows:

```
Defined clients:
  1: Rufus
  2: Matou
  3: Polymatou
  4: Minimatou
  5: Minou
  6: MatouVerify
  7: PmatouVerify
  8: RufusVerify
  9: Watchdog
Select Client (File daemon) resource (1-9):
```

You will probably have far fewer Clients than this example, and if you have only one Client, it will be automatically selected. In this case, I enter **Rufus** to select the Client. Then Bacula needs to know what FileSet is to be restored, so it prompts with:

```
The defined FileSet resources are:
  1: Full Set
  2: Other Files
Select FileSet resource (1-2):
```

If you have only one FileSet defined for the Client, it will be selected automatically. I choose item 1, which is my full backup. Normally, you will only have a single FileSet for each Job, and if your machines are similar (all Linux) you may only have one FileSet for all your Clients.

At this point, **Bacula** has all the information it needs to find the most recent set of backups. It will then query the database, which may take a bit of time, and it will come up with something like the following. Note, some of the columns are truncated here for presentation:

```
+-----+-----+-----+-----+-----+-----+-----+
| JobId | Lev1 | JobFiles | StartTime | VolumeName | File | SesId | VolSesTime |
+-----+-----+-----+-----+-----+-----+-----+
| 1,792 | F    | 128,374 | 08-03 01:58 | DLT-19Jul02 | 67 | 18 | 1028042998 |
| 1,792 | F    | 128,374 | 08-03 01:58 | DLT-04Aug02 | 0  | 18 | 1028042998 |
| 1,797 | I    | 254     | 08-04 13:53 | DLT-04Aug02 | 5  | 23 | 1028042998 |
| 1,798 | I    | 15      | 08-05 01:05 | DLT-04Aug02 | 6  | 24 | 1028042998 |
+-----+-----+-----+-----+-----+-----+-----+
```



```

You have selected the following JobId: 1792,1792,1797
Building directory tree for JobId 1792 ...
Building directory tree for JobId 1797 ...
Building directory tree for JobId 1798 ...
cwd is: /
$

```

Depending on the number of **JobFiles** for each JobId, the **Building directory tree ...** can take a bit of time. If you notice that all the JobFiles are zero, your Files have probably been pruned and you will not be able to select any individual files – it will be restore everything or nothing.

In our example, Bacula found four Jobs that comprise the most recent backup of the specified Client and FileSet. Two of the Jobs have the same JobId because that Job wrote on two different Volumes. The third Job was an incremental backup to the previous Full backup, and it only saved 254 Files compared to 128,374 for the Full backup. The fourth Job was also an incremental backup that saved 15 files.

Next Bacula entered those Jobs into the directory tree, with no files marked to be restored as a default, tells you how many files are in the tree, and tells you that the current working directory (**cwd**) is /. Finally, Bacula prompts with the dollar sign (\$) to indicate that you may enter commands to move around the directory tree and to select files.

If you want all the files to automatically be marked when the directory tree is built, you could have entered the command **restore all**, or at the \$ prompt, you can simply enter **mark ***.

Instead of choosing item 5 on the first menu (Select the most recent backup for a client), if we had chosen item 3 (Enter list of JobIds to select) and we had entered the JobIds **1792,1797,1798** we would have arrived at the same point.

One point to note, if you are manually entering JobIds, is that you must enter them in the order they were run (generally in increasing JobId order). If you enter them out of order and the same file was saved in two or more of the Jobs, you may end up with an old version of that file (i.e. not the most recent).

Directly entering the JobIds can also permit you to recover data from a Job that wrote files to tape but that terminated with an error status.

While in file selection mode, you can enter **help** or a question mark (?) to produce a summary of the available commands:

Command	Description
=====	=====
cd	change current directory
count	count marked files in and below the cd
dir	long list current directory, wildcards allowed
done	leave file selection mode
estimate	estimate restore size
exit	same as done command
find	find files, wildcards allowed
help	print help
ls	list current directory, wildcards allowed
lsmark	list the marked files in and below the cd
mark	mark dir/file to be restored recursively in dirs
markdir	mark directory name to be restored (no files)
pwd	print current working directory
unmark	unmark dir/file to be restored recursively in dir
unmarkdir	unmark directory name only no recursion
quit	quit and do not do restore
?	print help

As a default no files have been selected for restore (unless you added **all** to the command line. If you want to restore everything, at this point, you should enter **mark ***, and then **done** and **Bacula** will write the bootstrap records to a file and request your approval to start a restore job.

If you do not enter the above mentioned **mark *** command, you will start with an empty slate. Now you can simply start looking at the tree and **mark** particular files or directories you want restored. It is easy to make a mistake in specifying a file to mark or unmark, and Bacula's error handling is not perfect, so please check your work by using the **ls** or **dir** commands to see what files are actually selected. Any selected file has its name preceded by an asterisk.

To check what is marked or not marked, enter the **count** command, which displays:

```
128401 total files. 128401 marked to be restored.
```

Each of the above commands will be described in more detail in the next section. We continue with the above example, having accepted to restore all files as Bacula set by default. On entering the **done** command, Bacula prints:



```

Bootstrap records written to /home/kern/bacula/working/restore.bsr
The job will require the following
Volume(s)                Storage(s)                SD Device(s)
=====
DLT-19Jul02              Tape                      DLT8000
DLT-04Aug02              Tape                      DLT8000

128401 files selected to restore.
Run Restore job
JobName:   kernsrestore
Bootstrap: /home/kern/bacula/working/restore.bsr
Where:     /tmp/bacula-restores
Replace:   always
FileSet:   Other Files
Client:    Rufus
Storage:   Tape
When:      2006-12-11 18:20:33
Catalog:   MyCatalog
Priority:   10
OK to run? (yes/mod/no):

```

Please examine each of the items very carefully to make sure that they are correct. In particular, look at **Where**, which tells you where in the directory structure the files will be restored, and **Client**, which tells you which client will receive the files. Note that by default the Client which will receive the files is the Client that was backed up. These items will not always be completed with the correct values depending on which of the restore options you chose. You can change any of these default items by entering **mod** and responding to the prompts.

The above assumes that you have defined a **Restore Job** resource in your Director's configuration file. Normally, you will only need one Restore Job resource definition because by its nature, restoring is a manual operation, and using the Console interface, you will be able to modify the Restore Job to do what you want. An example Restore Job resource definition is given below.

Returning to the above example, you should verify that the Client name is correct before running the Job. However, you may want to modify some of the parameters of the restore job. For example, in addition to checking the Client it is wise to check that the Storage device chosen by Bacula is indeed correct. Although the **FileSet** is shown, it will be ignored in restore. The restore will choose the files to be restored either by reading the **Bootstrap** file, or if not specified, it will restore all files associated with the specified backup **JobId** (i.e. the JobId of the Job that originally backed up the files).

Finally before running the job, please note that the default location for restoring files is **not** their original locations, but rather the directory **/tmp/bacula-restores**. You can change this default by modifying your **bacula-dir.conf** file, or you can modify it using the **mod** option. If you want to restore the files to their original location, you must have **Where** set to nothing or to the root, i.e. **/**.

If you now enter **yes**, Bacula will run the restore Job. The Storage daemon will first request Volume **DLT-19Jul02** and after the appropriate files have been restored from that volume, it will request Volume **DLT-04Aug02**.

21.2.1 Restore a pruned job using a pattern

During a restore, if all File records are pruned from the catalog for a Job, normally Bacula can restore only all files saved. That is there is no way using the catalog to select individual files. With this new feature, Bacula will ask if you want to specify a Regex expression for extracting only a part of the full backup.

```

Building directory tree for JobId(s) 1,3 ...
There were no files inserted into the tree, so file selection
is not possible. Most likely your retention policy pruned the files

Do you want to restore all the files? (yes|no): no

Regex matching files to restore? (empty to abort): /tmp/regress/(bin|tests)/
Bootstrap records written to /tmp/regress/working/zog4-dir.restore.1.bsr

```

See also FileRegex bsr option for more information.



21.3 Selecting Files by Filename

If you have a small number of files to restore, and you know the filenames, you can either put the list of filenames in a file to be read by Bacula, or you can enter the names one at a time. The filenames must include the full path and filename. No wild cards are used.

To enter the files, after the **restore**, you select item number 7 from the prompt list:

```
To select the JobIds, you have the following choices:
  1: List last 20 Jobs run
  2: List Jobs where a given File is saved
  3: Enter list of comma separated JobIds to select
  4: Enter SQL list command
  5: Select the most recent backup for a client
  6: Select backup for a client before a specified time
  7: Enter a list of files to restore
  8: Enter a list of files to restore before a specified time
  9: Find the JobIds of the most recent backup for a client
 10: Find the JobIds for a backup for a client before a specified time
 11: Enter a list of directories to restore for found JobIds
 12: Cancel
Select item: (1-12):
```

which then prompts you for the client name:

```
Defined Clients:
  1: Timmy
  2: Tibs
  3: Rufus
Select the Client (1-3): 3
```

Of course, your client list will be different, and if you have only one client, it will be automatically selected. And finally, Bacula requests you to enter a filename:

```
Enter filename:
```

At this point, you can enter the full path and filename

```
Enter filename: /home/kern/bacula/k/Makefile.in
Enter filename:
```

as you can see, it took the filename. If Bacula cannot find a copy of the file, it prints the following:

```
Enter filename: junk filename
No database record found for: junk filename
Enter filename:
```

If you want Bacula to read the filenames from a file, you simply precede the filename with a less-than symbol (<). When you have entered all the filenames, you enter a blank line, and Bacula will write the bootstrap file, tells you what tapes will be used, and proposes a Restore job to be run:

```
Enter filename:
Automatically selected Storage: DDS-4
Bootstrap records written to /home/kern/bacula/working/restore.bsr
The restore job will require the following Volumes:
```

```
    test1
1 file selected to restore.
Run Restore job
JobName:   kernsrestore
Bootstrap: /home/kern/bacula/working/restore.bsr
Where:    /tmp/bacula-restores
Replace:  always
FileSet:  Other Files
Client:   Rufus
Storage:  DDS-4
When:    2003-09-11 10:20:53
Priority: 10
OK to run? (yes/mod/no):
```

It is possible to automate the selection by file by putting your list of files in say **/tmp/file-list**, then using the following command:

```
restore client=Rufus file=</tmp/file-list
```

If in modifying the parameters for the Run Restore job, you find that Bacula asks you to enter a Job number, this is because you have not yet specified either a Job number or a Bootstrap file. Simply entering zero will allow you to continue and to select another option to be modified.



21.4 Replace Options

When restoring, you have the option to specify a Replace option. This directive determines the action to be taken when restoring a file or directory that already exists. This directive can be set by selecting the **mod** option. You will be given a list of parameters to choose from. Full details on this option can be found in the Job Resource section of the Director documentation.

21.5 Command Line Arguments

If all the above sounds complicated, you will probably agree that it really isn't after trying it a few times. It is possible to do everything that was shown above, with the exception of selecting the FileSet, by using command line arguments with a single command by entering:

```
restore client=Rufus select current all done yes
```

The **client=Rufus** specification will automatically select Rufus as the client, the **current** tells Bacula that you want to restore the system to the most current state possible, and the **yes** suppresses the final **yes/mod/no** prompt and simply runs the restore.

The full list of possible command line arguments are:

- **all** – select all Files to be restored.
- **select** – use the tree selection method.
- **done** – do not prompt the user in tree mode.
- **current** – automatically select the most current set of backups for the specified client.
- **client=xxxx** – initially specifies the client from which the backup was made and the client to which the restore will be made. See also "restoreclient" keyword.
- **restoreclient=xxxx** – if the keyword is specified, then the restore is written to that client.
- **jobid=nnn** – specify a JobId or comma separated list of JobIds to be restored.
- **before=YYYY-MM-DD HH:MM:SS** – specify a date and time to which the system should be restored. Only Jobs started before the specified date/time will be selected, and as is the case for **current** Bacula will automatically find the most recent prior Full save and all Differential and Incremental saves run before the date you specify. Note, this command is not too user friendly in that you must specify the date/time exactly as shown.
- **file=filename** – specify a filename to be restored. You must specify the full path and filename. Prefixing the entry with a less-than sign (<) will cause Bacula to assume that the filename is on your system and contains a list of files to be restored. Bacula will thus read the list from that file. Multiple file=xxx specifications may be specified on the command line.
- **jobid=nnn** – specify a JobId to be restored.
- **pool=pool-name** – specify a Pool name to be used for selection of Volumes when specifying options 5 and 6 (restore current system, and restore current system before given date). This permits you to have several Pools, possibly one offsite, and to select the Pool to be used for restoring.
- **where=/tmp/bacula-restore** – restore files in **where** directory.
- **yes** – automatically run the restore without prompting for modifications (most useful in batch scripts).
- **strip_prefix=/prod** – remove a part of the filename when restoring.
- **add_prefix=/test** – add a prefix to all files when restoring (like where) (can't be used with **where=**).
- **add_suffix=.old** – add a suffix to all your files.
- **regexwhere=!a.pdf!a.bkp.pdf!** – do complex filename manipulation like with sed unix command. Will overwrite other filename manipulation.
- **restorejob=jobname** – Pre-chooses a restore job. Bacula can be configured with multiple restore jobs ("Type = Restore" in the job definition). This allows the specification of different restore properties, including a set of RunScripts. When more than one job of this type is configured, during restore, Bacula will ask for a user selection interactively, or use the given restorejob.



21.6 Using File Relocation

21.6.1 Introduction

The **where=** option is simple, but not very powerful. With file relocation, Bacula can restore a file to the same directory, but with a different name, or in an other directory without recreating the full path.

You can also do filename and path manipulations, implemented in Bacula 2.1.8 or later, such as adding a suffix to all your files, renaming files or directories, etc. These options will overwrite **where=** option.

For example, many users use OS snapshot features so that file `/home/eric/mbox` will be backed up from the directory `/.snap/home/eric/mbox`, which can complicate restores. If you use **where=/tmp**, the file will be restored to `/tmp/.snap/home/eric/mbox` and you will have to move the file to `/home/eric/mbox.bkp` by hand.

However, case, you could use the **strip_prefix=/.snap** and **add_suffix=.bkp** options and Bacula will restore the file to its original location – that is `/home/eric/mbox`.

To use this feature, there are command line options as described in the restore section of this manual; you can modify your restore job before running it; or you can add options to your restore job in as described in `bacula-dir.conf`.

Parameters to modify:

- 1: Level
- 2: Storage
- ...
- 10: File Relocation
- ...

Select parameter to modify (1-12):

This will replace your current Where value

- 1: Strip prefix
- 2: Add prefix
- 3: Add file suffix
- 4: Enter a regexp
- 5: Test filename manipulation
- 6: Use this ?

Select parameter to modify (1-6):

21.6.2 RegexWhere Format

The format is very close to that used by sed or Perl (`s/replace this/by that/`) operator. A valid regexwhere expression has three fields :

- a search expression (with optionnal submatch)
- a replacement expression (with optionnal back references \$1 to \$9)
- a set of search options (only case-insensitive “i” at this time)

Each field is delimited by a separator specified by the user as the first character of the expression. The separator can be one of the following:

`<separator-keyword> = / ! ; % : , ~ # = &`

You can use several expressions separated by a commas.

Examples

Original filename	New filename	RegexWhere	Comments
<code>c:/system.ini</code>	<code>c:/system.old.ini</code>	<code>/.ini\$/\.old.ini/</code>	\$ matches end of name
<code>/prod/u01/pdata/</code>	<code>/rect/u01/rdata</code>	<code>/prod/rect/,/pdata/rdata/</code>	uses two regexp
<code>/prod/u01/pdata/</code>	<code>/rect/u01/rdata</code>	<code>!/prod!/rect!/!,/pdata/rdata/</code>	use ! as separator
<code>C:/WINNT</code>	<code>d:/WINNT</code>	<code>/c:/d:/i</code>	case insensitive pattern match



Original filename	New filename	RegexWhere	Comments
-------------------	--------------	------------	----------

21.7 Restoring Directory Attributes

Depending how you do the restore, you may or may not get the directory entries back to their original state. Here are a few of the problems you can encounter, and for some machine restores, how to avoid them.

- You backed up on one machine and are restoring to another that is either a different OS or doesn't have the same users/groups defined. Bacula does the best it can in these situations. Note, Bacula has saved the user/groups in numeric form, which means on a different machine, they may map to different user/group names.
- You are restoring into a directory that is already created and has file creation restrictions. Bacula tries to reset everything but without walking up the full chain of directories and modifying them all during the restore, which Bacula does and will not do, getting permissions back correctly in this situation depends to a large extent on your OS.
- You are doing a recursive restore of a directory tree. In this case Bacula will restore a file before restoring the file's parent directory entry. In the process of restoring the file Bacula will create the parent directory with open permissions and ownership of the file being restored. Then when Bacula tries to restore the parent directory Bacula sees that it already exists (Similar to the previous situation). If you had set the Restore job's "Replace" property to "never" then Bacula will not change the directory's permissions and ownerships to match what it backed up, you should also notice that the actual number of files restored is less than the expected number. If you had set the Restore job's "Replace" property to "always" then Bacula will change the Directory's ownership and permissions to match what it backed up, also the actual number of files restored should be equal to the expected number.
- You selected one or more files in a directory, but did not select the directory entry to be restored. In that case, if the directory is not on disk Bacula simply creates the directory with some default attributes which may not be the same as the original. If you do not select a directory and all its contents to be restored, you can still select items within the directory to be restored by individually marking those files, but in that case, you should individually use the "markdir" command to select all higher level directory entries (one at a time) to be restored if you want the directory entries properly restored.
- The **bextract** program does not restore access control lists (ACLs) to Unix machines.

21.8 Restoring on Windows

If you are restoring on WinNT/2K/XP systems, Bacula will restore the files with the original ownerships and permissions as would be expected. This is also true if you are restoring those files to an alternate directory (using the Where option in restore). However, if the alternate directory does not already exist, the Bacula File daemon (Client) will try to create it. In some cases, it may not create the directories, and if it does since the File daemon runs under the SYSTEM account, the directory will be created with SYSTEM ownership and permissions. In this case, you may have problems accessing the newly restored files.

To avoid this problem, you should create any alternate directory before doing the restore. Bacula will not change the ownership and permissions of the directory if it is already created as long as it is not one of the directories being restored (i.e. written to tape).

The default restore location is **/tmp/bacula-restores/** and if you are restoring from drive **E:**, the default will be **/tmp/bacula-restores/e/**, so you should ensure that this directory exists before doing the restore, or use the **mod** option to select a different **where** directory that does exist.

Some users have experienced problems restoring files that participate in the Active Directory. They also report that changing the userid under which Bacula (bacula-fd.exe) runs, from SYSTEM to a Domain Admin userid, resolves the problem.

21.9 Restoring Files Can Be Slow

Restoring files is generally **much** slower than backing them up for several reasons. The first is that during a backup the tape is normally already positioned and Bacula only needs to write. On the other hand, because



restoring files is done so rarely, Bacula keeps only the start file and block on the tape for the whole job rather than on a file by file basis which would use quite a lot of space in the catalog.

Bacula will forward space to the correct file mark on the tape for the Job, then forward space to the correct block, and finally sequentially read each record until it gets to the correct one(s) for the file or files you want to restore. Once the desired files are restored, Bacula will stop reading the tape.

Finally, instead of just reading a file for backup, during the restore, Bacula must create the file, and the operating system must allocate disk space for the file as Bacula is restoring it.

For all the above reasons the restore process is generally much slower than backing up (sometimes it takes three times as long).

21.10 Problems Restoring Files

The most frequent problems users have restoring files are error messages such as:

```
04-Jan 00:33 z217-sd: RestoreFiles.2005-01-04_00.31.04 Error:
block.c:868 Volume data error at 20:0! Short block of 512 bytes on
device /dev/tape discarded.
```

or

```
04-Jan 00:33 z217-sd: RestoreFiles.2005-01-04_00.31.04 Error:
block.c:264 Volume data error at 20:0! Wanted ID: "BB02", got ".".
Buffer discarded.
```

Both these kinds of messages indicate that you were probably running your tape drive in fixed block mode rather than variable block mode. Fixed block mode will work with any program that reads tapes sequentially such as tar, but Bacula repositions the tape on a block basis when restoring files because this will speed up the restore by orders of magnitude when only a few files are being restored. There are several ways that you can attempt to recover from this unfortunate situation.

Try the following things, each separately, and reset your Device resource to what it is now after each individual test:

1. Set "Block Positioning = no" in your Device resource and try the restore. This is a new directive and untested.
2. Set "Minimum Block Size = 512" and "Maximum Block Size = 512" and try the restore. If you are able to determine the block size your drive was previously using, you should try that size if 512 does not work. This is a really horrible solution, and it is not at all recommended to continue backing up your data without correcting this condition. Please see the Tape Testing chapter for more on this.
3. Try editing the restore.bsr file at the Run xxx yes/mod/no prompt before starting the restore job and remove all the VolBlock statements. These are what causes Bacula to reposition the tape, and where problems occur if you have a fixed block size set for your drive. The VolFile commands also cause repositioning, but this will work regardless of the block size.
4. Use bextract to extract the files you want – it reads the Volume sequentially if you use the include list feature, or if you use a .bsr file, but remove all the VolBlock statements after the .bsr file is created (at the Run yes/mod/no) prompt but before you start the restore.

21.11 Restore Errors

There are a number of reasons why there may be restore errors or warning messages. Some of the more common ones are:

file count mismatch This can occur for the following reasons:

- You requested Bacula not to overwrite existing or newer files.
- A Bacula miscount of files/directories. This is an on-going problem due to the complications of directories, soft/hard link, and such. Simply check that all the files you wanted were actually restored.



file size error When Bacula restores files, it checks that the size of the restored file is the same as the file status data it saved when starting the backup of the file. If the sizes do not agree, Bacula will print an error message. This size mismatch most often occurs because the file was being written as Bacula backed up the file. In this case, the size that Bacula restored will be greater than the status size. This often happens with log files.

If the restored size is smaller, then you should be concerned about a possible tape error and check the Bacula output as well as your system logs.

21.12 Example Restore Job Resource

```
Job {
  Name = "RestoreFiles"
  Type = Restore
  Client = Any-client
  FileSet = "Any-FileSet"
  Storage = Any-storage
  Where = /tmp/bacula-restores
  Messages = Standard
  Pool = Default
}
```

If **Where** is not specified, the default location for restoring files will be their original locations.

21.13 File Selection Commands

After you have selected the Jobs to be restored and Bacula has created the in-memory directory tree, you will enter file selection mode as indicated by the dollar sign (\$) prompt. While in this mode, you may use the commands listed above. The basic idea is to move up and down the in memory directory structure with the **cd** command much as you normally do on the system. Once you are in a directory, you may select the files that you want restored. As a default no files are marked to be restored. If you wish to start with all files, simply enter: **cd /** and **mark ***. Otherwise proceed to select the files you wish to restore by marking them with the **mark** command. The available commands are:

cd The **cd** command changes the current directory to the argument specified. It operates much like the Unix **cd** command. Wildcard specifications are not permitted.

Note, on Windows systems, the various drives (c:, d:, ...) are treated like a directory within the file tree while in the file selection mode. As a consequence, you must do a **cd c:** or possibly in some cases a **cd C:** (note upper case) to get down to the first directory.

dir The **dir** command is similar to the **ls** command, except that it prints it in long format (all details). This command can be a bit slower than the **ls** command because it must access the catalog database for the detailed information for each file.

estimate The **estimate** command prints a summary of the total files in the tree, how many are marked to be restored, and an estimate of the number of bytes to be restored. This can be useful if you are short on disk space on the machine where the files will be restored.

find The **find** command accepts one or more arguments and displays all files in the tree that match that argument. The argument may have wildcards. It is somewhat similar to the Unix command **find / -name arg**.

ls The **ls** command produces a listing of all the files contained in the current directory much like the Unix **ls** command. You may specify an argument containing wildcards, in which case only those files will be listed.

Any file that is marked to be restored will have its name preceded by an asterisk (*). Directory names will be terminated with a forward slash (/) to distinguish them from filenames.

lsmark The **lsmark** command is the same as the **ls** except that it will print only those files marked for extraction. The other distinction is that it will recursively descend into any directory selected.

mark The **mark** command allows you to mark files to be restored. It takes a single argument which is the filename or directory name in the current directory to be marked for extraction. The argument may be a wildcard specification, in which case all files that match in the current directory are marked to



be restored. If the argument matches a directory rather than a file, then the directory and all the files contained in that directory (recursively) are marked to be restored. Any marked file will have its name preceded with an asterisk (*) in the output produced by the **ls** or **dir** commands. Note, supplying a full path on the mark command does not work as expected to select a file or directory in the current directory. Also, the **mark** command works on the current and lower directories but does not touch higher level directories.

After executing the **mark** command, it will print a brief summary:

```
No files marked.
```

If no files were marked, or:

```
nm files marked.
```

if some files are marked.

unmark The **unmark** is identical to the **mark** command, except that it unmarks the specified file or files so that they will not be restored. Note: the **unmark** command works from the current directory, so it does not unmark any files at a higher level. First do a **cd /** before the **unmark *** command if you want to unmark everything.

pwd The **pwd** command prints the current working directory. It accepts no arguments.

count The **count** command prints the total files in the directory tree and the number of files marked to be restored.

done This command terminates file selection mode.

exit This command terminates file selection mode (the same as done).

quit This command terminates the file selection and does not run the restore job.

help This command prints a summary of the commands available.

? This command is the same as the **help** command.

If your filename contains some weird characters, you can use **?**, ***** or ****. For example, if your filename contains a ****, you can use ****.

```
* mark weird_file\\with-backslash
```

21.14 Restoring When Things Go Wrong

This and the following sections will try to present a few of the kinds of problems that can come up making restoring more difficult. We will try to provide a few ideas how to get out of these problem situations. In addition to what is presented here, there is more specific information on restoring a Client and your Server in the Disaster Recovery Using Bacula chapter of this manual.

Problem My database is broken.

Solution For SQLite, use the vacuum command to try to fix the database. For either MySQL or PostgreSQL, see the vendor's documentation. They have specific tools that check and repair databases, see the database repair sections of this manual for links to vendor information.

Assuming the above does not resolve the problem, you will need to restore or rebuild your catalog. Note, if it is a matter of some inconsistencies in the Bacula tables rather than a broken database, then running the **dbcheck** command (command 1.12 on page 16) ¹ might help, but you will need to ensure that your database indexes are properly setup. Please see the Database Performance Issues sections of this manual for more details.

¹Bacula Community Utility programs



Problem How do I restore my catalog?

Solution with a Catalog backup If you have backed up your database nightly (as you should) and you have made a bootstrap file, you can immediately load back your database (or the ASCII SQL output). Make a copy of your current database, then re-initialize it, by running the following scripts:

```
./drop_bacula_tables
./make_bacula_tables
```

After re-initializing the database, you should be able to run Bacula. If you now try to use the restore command, it will not work because the database will be empty. However, you can manually run a restore job and specify your bootstrap file. You do so by entering the `bf run` command in the console and selecting the restore job. If you are using the default `bacula-dir.conf`, this Job will be named **RestoreFiles**. Most likely it will prompt you with something such as:

```
Run Restore job
JobName:      RestoreFiles
Bootstrap:    /home/kern/bacula/working/restore.bsr
Where:        /tmp/bacula-restores
Replace:      always
FileSet:      Full Set
Client:       rufus-fd
Storage:      File
When:         2005-07-10 17:33:40
Catalog:      MyCatalog
Priority:      10
OK to run? (yes/mod/no):
```

A number of the items will be different in your case. What you want to do is: to use the `mod` option to change the Bootstrap to point to your saved bootstrap file; and to make sure all the other items such as Client, Storage, Catalog, and Where are correct. The FileSet is not used when you specify a bootstrap file. Once you have set all the correct values, run the Job and it will restore the backup of your database, which is most likely an ASCII dump.

You will then need to follow the instructions for your database type to recreate the database from the ASCII backup file. See the Catalog Maintenance chapter of this manual for examples of the command needed to restore a database from an ASCII dump (they are shown in the Compacting Your XXX Database sections).

Also, please note that after you restore your database from an ASCII backup, you do NOT want to do a `make_bacula_tables` command, or you will probably erase your newly restored database tables.

Solution with a Job listing If you did save your database but did not make a bootstrap file, then recovering the database is more difficult. You will probably need to use `bextract` to extract the backup copy. First you should locate the listing of the job report from the last catalog backup. It has important information that will allow you to quickly find your database file. For example, in the job report for the CatalogBackup shown below, the critical items are the Volume name(s), the Volume Session Id and the Volume Session Time. If you know those, you can easily restore your Catalog.

```
22-Apr 10:22 HeadMan: Start Backup JobId 7510,
Job=CatalogBackup.2005-04-22_01.10.0
22-Apr 10:23 HeadMan: Bacula 1.37.14 (21Apr05): 22-Apr-2005 10:23:06
  JobId:          7510
  Job:            CatalogBackup.2005-04-22_01.10.00
  Backup Level:   Full
  Client:         Polymatou
  FileSet:        "CatalogFile" 2003-04-10 01:24:01
  Pool:           "Default"
  Storage:        "DLTDrive"
  Start time:     22-Apr-2005 10:21:00
  End time:       22-Apr-2005 10:23:06
  FD Files Written: 1
  SD Files Written: 1
  FD Bytes Written: 210,739,395
  SD Bytes Written: 210,739,521
  Rate:           1672.5 KB/s
  Software Compression: None
  Volume name(s): DLT-22Apr05
  Volume Session Id: 11
```



```
Volume Session Time: 1114075126
Last Volume Bytes: 1,428,240,465
Non-fatal FD errors: 0
SD Errors: 0
FD termination status: OK
SD termination status: OK
Termination: Backup OK
```

From the above information, you can manually create a bootstrap file, and then follow the instructions given above for restoring your database. A reconstructed bootstrap file for the above backup Job would look like the following:

```
Volume="DLT-22Apr05"
VolSessionId=11
VolSessionTime=1114075126
FileIndex=1-1
```

Where we have inserted the Volume name, Volume Session Id, and Volume Session Time that correspond to the values in the job report. We've also used a FileIndex of one, which will always be the case providing that there was only one file backed up in the job.

The disadvantage of this bootstrap file compared to what is created when you ask for one to be written, is that there is no File and Block specified, so the restore code must search all data in the Volume to find the requested file. A fully specified bootstrap file would have the File and Blocks specified as follows:

```
Volume="DLT-22Apr05"
VolSessionId=11
VolSessionTime=1114075126
VolFile=118-118
VolBlock=0-4053
FileIndex=1-1
```

Once you have restored the ASCII dump of the database, you will then to follow the instructions for your database type to recreate the database from the ASCII backup file. See the Catalog Maintenance chapter of this manual for examples of the command needed to restore a database from an ASCII dump (they are shown in the Compacting Your XXX Database sections).

Also, please note that after you restore your database from an ASCII backup, you do NOT want to do a **make_bacula_tables** command, or you will probably erase your newly restored database tables.

Solution without a Job Listing If you do not have a job listing, then it is a bit more difficult. Either you use the **bscan** program (program 1.7 on page 8) to scan the contents of your tape into a database, which can be very time consuming depending on the size of the tape, or you can use the **bls** program (program 1.5 on page 4) to list everything on the tape, and reconstruct a bootstrap file from the bls listing for the file or files you want following the instructions given above.

There is a specific example of how to use **bls** below.

Problem I try to restore the last known good full backup by specifying item 3 on the restore menu then the JobId to restore. Bacula then reports:

```
1 Job 0 Files
```

and restores nothing.

Solution Most likely the File records were pruned from the database either due to the File Retention period expiring or by explicitly purging the Job. By using the "list jobid=nn" command, you can obtain all the important information about the job:

```
l1list jobid=120
    JobId: 120
    Job: save.2005-12-05_18.27.33
    Job.Name: save
    PurgedFiles: 0
    Type: B
    Level: F
    Job.ClientId: 1
```



```

Client.Name: Rufus
JobStatus: T
SchedTime: 2005-12-05 18:27:32
StartTime: 2005-12-05 18:27:35
EndTime: 2005-12-05 18:27:37
JobTDate: 1133803657
VolSessionId: 1
VolSessionTime: 1133803624
JobFiles: 236
JobErrors: 0
JobMissingFiles: 0
Job.PoolId: 4
Pool.Name: Full
Job.FileSetId: 1
FileSet.FileSet: BackupSet

```

Then you can find the Volume(s) used by doing:

```

sql
select VolumeName from JobMedia,Media where JobId=1 and JobMedia.MediaId=Media.MediaId;

```

Finally, you can create a bootstrap file as described in the previous problem above using this information.

If you are using Bacula version 1.38.0 or greater, when you select item 3 from the menu and enter the JobId, it will ask you if you would like to restore all the files in the job, and it will collect the above information and write the bootstrap file for you.

Problem You don't have a bootstrap file, and you don't have the Job report for the backup of your database, but you did backup the database, and you know the Volume to which it was backed up.

Solution Either bscan the tape (see below for bscanning), or better use **bls** to find where it is on the tape, then use **bextract** to restore the database. For example,

```
./bls -j -V DLT-22Apr05 /dev/nst0
```

Might produce the following output:

```

bls: butil.c:258 Using device: "/dev/nst0" for reading.
21-Jul 18:34 bls: Ready to read from volume "DLT-22Apr05" on device "DLTDrive"
(/dev/nst0).
Volume Record: File:blk=0:0 SessId=11 SessTime=1114075126 JobId=0 DataLen=164
...
Begin Job Session Record: File:blk=118:0 SessId=11 SessTime=1114075126
JobId=7510
Job=CatalogBackup.2005-04-22_01.10.0 Date=22-Apr-2005 10:21:00 Level=F Type=B
End Job Session Record: File:blk=118:4053 SessId=11 SessTime=1114075126
JobId=7510
Date=22-Apr-2005 10:23:06 Level=F Type=B Files=1 Bytes=210,739,395 Errors=0
Status=T
...
21-Jul 18:34 bls: End of Volume at file 201 on device "DLTDrive" (/dev/nst0),
Volume "DLT-22Apr05"
21-Jul 18:34 bls: End of all volumes.

```

Of course, there will be many more records printed, but we have indicated the essential lines of output. From the information on the Begin Job and End Job Session Records, you can reconstruct a bootstrap file such as the one shown above.

Problem How can I find where a file is stored.

Solution Normally, it is not necessary, you just use the **restore** command to restore the most recently saved version (menu option 5), or a version saved before a given date (menu option 8). If you know the JobId of the job in which it was saved, you can use menu option 3 to enter that JobId.

If you would like to know the JobId where a file was saved, select restore menu option 2.

You can also use the **query** command to find information such as:



*query

Available queries:

- 1: List up to 20 places where a File is saved regardless of the directory
- 2: List where the most recent copies of a file are saved
- 3: List last 20 Full Backups for a Client
- 4: List all backups for a Client after a specified time
- 5: List all backups for a Client
- 6: List Volume Attributes for a selected Volume
- 7: List Volumes used by selected JobId
- 8: List Volumes to Restore All Files
- 9: List Pool Attributes for a selected Pool
- 10: List total files/bytes by Job
- 11: List total files/bytes by Volume
- 12: List Files for a selected JobId
- 13: List Jobs stored on a selected MediaId
- 14: List Jobs stored for a given Volume name
- 15: List Volumes Bacula thinks are in changer
- 16: List Volumes likely to need replacement from age or errors

Choose a query (1-16):

Problem I didn't backup my database. What do I do now?

Solution This is probably the worst of all cases, and you will probably have to re-create your database from scratch and then bscan in all your Volumes, which is a very long, painful, and inexact process.

There are basically three steps to take:

1. Ensure that your SQL server is running (MySQL or PostgreSQL) and that the Bacula database (normally bacula) exists. See the Installation chapter of the manual.
2. Ensure that the Bacula databases are created. This is also described at the above link.
3. Start and stop the Bacula Director using the appropriate bacula-dir.conf file so that it can create the Client and Storage records which are not stored on the Volumes. Without these records, scanning is unable to connect the Job records to the proper client.

When the above is complete, you can begin bscanning your Volumes. Please see the **bscan** section (section 1.7 on page 8) of the Bacula Community Utility programs.



Chapter 22

Automatic Volume Recycling

By default, once Bacula starts writing a Volume, it can append to the volume, but it will not overwrite the existing data thus destroying it. However when Bacula **recycles** a Volume, the Volume becomes available for being reused, and Bacula can at some later time overwrite the previous contents of that Volume. Thus all previous data will be lost. If the Volume is a tape, the tape will be rewritten from the beginning. If the Volume is a disk file, the file will be truncated before being rewritten.

You may not want Bacula to automatically recycle (reuse) tapes. This would require a large number of tapes though, and in such a case, it is possible to manually recycle tapes. For more on manual recycling, see the section entitled Manually Recycling Volumes below in this chapter.

Most people prefer to have a Pool of tapes that are used for daily backups and recycled once a week, another Pool of tapes that are used for Full backups once a week and recycled monthly, and finally a Pool of tapes that are used once a month and recycled after a year or two. With a scheme like this, the number of tapes in your pool or pools remains constant.

By properly defining your Volume Pools with appropriate Retention periods, Bacula can manage the recycling (such as defined above) automatically.

Automatic recycling of Volumes is controlled by four records in the **Pool** resource definition in the Director's configuration file. These four records are:

- AutoPrune = yes
- VolumeRetention = <time>
- Recycle = yes
- RecyclePool = <APool>

The above three directives are all you need assuming that you fill each of your Volumes then wait the Volume Retention period before reusing them. If you want Bacula to stop using a Volume and recycle it before it is full, you will need to use one or more additional directives such as:

- Use Volume Once = yes
- Volume Use Duration = ttt
- Maximum Volume Jobs = nnn
- Maximum Volume Bytes = mmm

Please see below and the Basic Volume Management chapter of this manual for more complete examples. Automatic recycling of Volumes is performed by Bacula only when it wants a new Volume and no appendable Volumes are available in the Pool. It will then search the Pool for any Volumes with the **Recycle** flag set and the Volume Status is **Purged**. At that point, it will choose the oldest purged volume and recycle it.

If there are no volumes with Status **Purged**, then the recycling occurs in two steps: The first is that the Catalog for a Volume must be pruned of all Jobs (i.e. Purged). Files contained on that Volume, and the second step is the actual recycling of the Volume. Only Volumes marked **Full** or **Used** will be considered for pruning. The Volume will be purged if the VolumeRetention period has expired. When a Volume is marked as Purged, it means that no Catalog records reference that Volume, and the Volume can be recycled. Until recycling actually occurs, the Volume data remains intact. If no Volumes can be found for recycling for any of the reasons stated above, Bacula will request operator intervention (i.e. it will ask you to label a new volume).



A key point mentioned above, that can be a source of frustration, is that Bacula will only recycle purged Volumes if there is no other appendable Volume available, otherwise, it will always write to an appendable Volume before recycling even if there are Volume marked as Purged. This preserves your data as long as possible. So, if you wish to "force" Bacula to use a purged Volume, you must first ensure that no other Volume in the Pool is marked **Append**. If necessary, you can manually set a volume to **Full**. The reason for this is that Bacula wants to preserve the data on your old tapes (even though purged from the catalog) as long as absolutely possible before overwriting it. There are also a number of directives such as **Volume Use Duration** that will automatically mark a volume as **Used** and thus no longer appendable.

22.1 Automatic Pruning

As Bacula writes files to tape, it keeps a list of files, jobs, and volumes in a database called the catalog. Among other things, the database helps Bacula to decide which files to back up in an incremental or differential backup, and helps you locate files on past backups when you want to restore something. However, the catalog will grow larger and larger as time goes on, and eventually it can become unacceptably large.

Bacula's process for removing entries from the catalog is called Pruning. The default is Automatic Pruning, which means that once an entry reaches a certain age (e.g. 30 days old) it is removed from the catalog. Note that Job records that are required for current restore won't be removed automatically, and File records are needed for VirtualFull and Accurate backups. Once a job has been pruned, you can still restore it from the backup tape, but one additional step is required: scanning the volume with `bscan`. The alternative to Automatic Pruning is Manual Pruning, in which you explicitly tell Bacula to erase the catalog entries for a volume. You'd usually do this when you want to reuse a Bacula volume, because there's no point in keeping a list of files that USED TO BE on a tape. Or, if the catalog is starting to get too big, you could prune the oldest jobs to save space. Manual pruning is done with the `prune` command (command 1.5 on page 9) in the Bacula Community Console Manual (thanks to Bryce Denney for the above explanation).

22.2 Pruning Directives

There are three pruning durations. All apply to catalog database records and not to the actual data in a Volume. The pruning (or retention) durations are for: Volumes (Media records), Jobs (Job records), and Files (File records). The durations inter-depend a bit because if Bacula prunes a Volume, it automatically removes all the Job records, and all the File records. Also when a Job record is pruned, all the File records for that Job are also pruned (deleted) from the catalog.

Having the File records in the database means that you can examine all the files backed up for a particular Job. They take the most space in the catalog (probably 90-95% of the total). When the File records are pruned, the Job records can remain, and you can still examine what Jobs ran, but not the details of the Files backed up. In addition, without the File records, you cannot use the Console restore command to restore the files.

When a Job record is pruned, the Volume (Media record) for that Job can still remain in the database, and if you do a "list volumes", you will see the volume information, but the Job records (and its File records) will no longer be available.

In each case, pruning removes information about where older files are, but it also prevents the catalog from growing to be too large. You choose the retention periods in function of how many files you are backing up and the time periods you want to keep those records online, and the size of the database. You can always re-insert the records (with 98% of the original data) by using "bscan" to scan in a whole Volume or any part of the volume that you want.

By setting **AutoPrune** to **yes** you will permit **Bacula** to automatically prune all Volumes in the Pool when a Job needs another Volume. Volume pruning means removing records from the catalog. It does not shrink the size of the Volume or affect the Volume data until the Volume gets overwritten. When a Job requests another volume and there are no Volumes with Volume Status **Append** available, Bacula will begin volume pruning. This means that all Jobs that are older than the **VolumeRetention** period will be pruned from every Volume that has Volume Status **Full** or **Used** and has **Recycle** set to **yes**. Pruning consists of deleting the corresponding Job, File, and JobMedia records from the catalog database. No change to the physical data on the Volume occurs during the pruning process. When all files are pruned from a Volume (i.e. no records in the catalog), the Volume will be marked as **Purged** implying that no Jobs remain on the volume. The Pool records that control the pruning are described below.

AutoPrune = `<yes—no>` If **AutoPrune** is set to **yes** (default), Bacula will automatically apply the Volume retention period when running a Job and it needs a new Volume but no appendable volumes



are available. At that point, Bacula will prune all Volumes that can be pruned (i.e. AutoPrune set) in an attempt to find a usable volume. If during the autopruning, all files are pruned from the Volume, it will be marked with VolStatus **Purged**. The default is **yes**. Note, that although the File and Job records may be pruned from the catalog, a Volume will be marked Purged (and hence ready for recycling) if the Volume status is Append, Full, Used, or Error. If the Volume has another status, such as Archive, Read-Only, Disabled, Busy, or Cleaning, the Volume status will not be changed to Purged.

Volume Retention = <time-period-specification> The Volume Retention record defines the length of time that Bacula will guarantee that the Volume is not reused counting from the time the last job stored on the Volume terminated. A key point is that this time period is not even considered as long as the Volume remains appendable. The Volume Retention period count down begins only when the Append status has been changed to some other status (Full, Used, Purged, ...).

When this time period expires, and if **AutoPrune** is set to **yes**, and a new Volume is needed, but no appendable Volume is available, Bacula will prune (remove) Job records that are older than the specified Volume Retention period.

The Volume Retention period takes precedence over any Job Retention period you have specified in the Client resource. It should also be noted, that the Volume Retention period is obtained by reading the Catalog Database Media record rather than the Pool resource record. This means that if you change the VolumeRetention in the Pool resource record, you must ensure that the corresponding change is made in the catalog by using the **update pool** command. Doing so will insure that any new Volumes will be created with the changed Volume Retention period. Any existing Volumes will have their own copy of the Volume Retention period that can only be changed on a Volume by Volume basis using the **update volume** command.

When all file catalog entries are removed from the volume, its VolStatus is set to **Purged**. The files remain physically on the Volume until the volume is overwritten.

Retention periods are specified in seconds, minutes, hours, days, weeks, months, quarters, or years on the record. See the Configuration chapter of this manual for additional details of time specification.

The default is 1 year.

Recycle = <yes—no> This statement tells Bacula whether or not the particular Volume can be recycled (i.e. rewritten). If Recycle is set to **no** (the default), then even if Bacula prunes all the Jobs on the volume and it is marked **Purged**, it will not consider the tape for recycling. If Recycle is set to **yes** and all Jobs have been pruned, the volume status will be set to **Purged** and the volume may then be reused when another volume is needed. If the volume is reused, it is relabeled with the same Volume Name, however all previous data will be lost.

It is also possible to "force" pruning of all Volumes in the Pool associated with a Job by adding **Prune Files = yes** to the Job resource.

22.3 Recycling Algorithm

After all Volumes of a Pool have been pruned (as mentioned above, this happens when a Job needs a new Volume and no appendable Volumes are available), Bacula will look for the oldest Volume that is Purged (all Jobs and Files expired), and if the **Recycle** flag is on (Recycle=yes) for that Volume, Bacula will relabel it and write new data on it.

As mentioned above, there are two key points for getting a Volume to be recycled. First, the Volume must no longer be marked Append (there are a number of directives to automatically make this change), and second since the last write on the Volume, one or more of the Retention periods must have expired so that there are no more catalog backup job records that reference that Volume. Once both those conditions are satisfied, the volume can be marked Purged and hence recycled.

The full algorithm that Bacula uses when it needs a new Volume is:

The algorithm described below assumes that AutoPrune is enabled, that Recycling is turned on, and that you have defined appropriate Retention periods, or used the defaults for all these items.

- If the request is for an Autochanger device, look only for Volumes in the Autochanger (i.e. with InChanger set and that have the correct Storage device).
- Search the Pool for a Volume with VolStatus=Append (if there is more than one, the Volume with the oldest date last written is chosen. If two have the same date then the one with the lowest MediaId is chosen).



- Search the Pool for a Volume with VolStatus=Recycle and the InChanger flag is set true (if there is more than one, the Volume with the oldest date last written is chosen. If two have the same date then the one with the lowest MediaId is chosen).
- Try recycling any purged Volumes.
- Prune volumes applying Volume retention period (Volumes with VolStatus Full, Used, or Append are pruned). Note, even if all the File and Job records are pruned from a Volume, the Volume will not be marked Purged until the Volume retention period expires.
- Search the Pool for a Volume with VolStatus=Purged
- If a Pool named "Scratch" exists, search for a Volume and if found move it to the current Pool for the Job and use it. Note, when the Scratch Volume is moved into the current Pool, the basic Pool defaults are applied as if it is a newly labeled Volume (equivalent to an **update volume from pool** command).
- If we were looking for Volumes in the Autochanger, go back to step 2 above, but this time, look for any Volume whether or not it is in the Autochanger.
- Attempt to create a new Volume if automatic labeling enabled If Python is enabled, a Python NewVolume event is generated before the Label Format directive is used. If the maximum number of Volumes specified for the pool is reached, a new Volume will not be created.
- Prune the oldest Volume if RecycleOldestVolume=yes (the Volume with the oldest LastWritten date and VolStatus equal to Full, Recycle, Purged, Used, or Append is chosen). This record ensures that all retention periods are properly respected.
- Purge the oldest Volume if PurgeOldestVolume=yes (the Volume with the oldest LastWritten date and VolStatus equal to Full, Recycle, Purged, Used, or Append is chosen). We strongly recommend against the use of **PurgeOldestVolume** as it can quite easily lead to loss of current backup data.
- Give up and ask operator.

The above occurs when Bacula has finished writing a Volume or when no Volume is present in the drive.

On the other hand, if you have inserted a different Volume after the last job, and Bacula recognizes the Volume as valid, it will request authorization from the Director to use this Volume. In this case, if you have set **Recycle Current Volume = yes** and the Volume is marked as Used or Full, Bacula will prune the volume and if all jobs were removed during the pruning (respecting the retention periods), the Volume will be recycled and used.

The recycling algorithm in this case is:

- If the VolStatus is **Append** or **Recycle** is set, the volume will be used.
- If **Recycle Current Volume** is set and the volume is marked **Full** or **Used**, Bacula will prune the volume (applying the retention period). If all Jobs are pruned from the volume, it will be recycled.

This permits users to manually change the Volume every day and load tapes in an order different from what is in the catalog, and if the volume does not contain a current copy of your backup data, it will be used.

A few points from Alan Brown to keep in mind:

1. If a pool doesn't have maximum volumes defined then Bacula will prefer to demand new volumes over forcibly purging older volumes.
2. If volumes become free through pruning and the Volume retention period has expired, then they get marked as "purged" and are immediately available for recycling - these will be used in preference to creating new volumes.
3. If the Job, File, and Volume retention periods are different, then it's common to see a tape with no files or jobs listed in the database, but which is still not marked as "purged".

22.4 Recycle Status

Each Volume inherits the Recycle status (yes or no) from the Pool resource record when the Media record is created (normally when the Volume is labeled). This Recycle status is stored in the Media record of the Catalog. Using the Console program, you may subsequently change the Recycle status for each Volume. For example in the following output from **list volumes**:

```

+-----+-----+-----+-----+-----+-----+
| VolumeNa | Media | VolSta | VolByte | LastWritte | VolRet | Rec |
+-----+-----+-----+-----+-----+-----+
| File0001 | File  | Full   | 4190055 | 2002-05-25 | 14400 | 1  |
| File0002 | File  | Full   | 1896460 | 2002-05-26 | 14400 | 1  |
| File0003 | File  | Full   | 1896460 | 2002-05-26 | 14400 | 1  |
| File0004 | File  | Full   | 1896460 | 2002-05-26 | 14400 | 1  |
| File0005 | File  | Full   | 1896460 | 2002-05-26 | 14400 | 1  |
| File0006 | File  | Full   | 1896460 | 2002-05-26 | 14400 | 1  |
| File0007 | File  | Purged | 1896466 | 2002-05-26 | 14400 | 1  |
+-----+-----+-----+-----+-----+-----+
    
```

all the volumes are marked as recyclable, and the last Volume, **File0007** has been purged, so it may be immediately recycled. The other volumes are all marked recyclable and when their Volume Retention period (14400 seconds or four hours) expires, they will be eligible for pruning, and possibly recycling. Even though Volume **File0007** has been purged, all the data on the Volume is still recoverable. A purged Volume simply means that there are no entries in the Catalog. Even if the Volume Status is changed to **Recycle**, the data on the Volume will be recoverable. The data is lost only when the Volume is re-labeled and re-written. To modify Volume **File0001** so that it cannot be recycled, you use the **update volume pool=File** command in the console program, or simply **update** and Bacula will prompt you for the information.

```

+-----+-----+-----+-----+-----+-----+
| VolumeNa | Media | VolSta | VolByte | LastWritten | VolRet | Rec |
+-----+-----+-----+-----+-----+-----+
| File0001 | File  | Full   | 4190055 | 2002-05-25 | 14400 | 0  |
| File0002 | File  | Full   | 1897236 | 2002-05-26 | 14400 | 1  |
| File0003 | File  | Full   | 1896460 | 2002-05-26 | 14400 | 1  |
| File0004 | File  | Full   | 1896460 | 2002-05-26 | 14400 | 1  |
| File0005 | File  | Full   | 1896460 | 2002-05-26 | 14400 | 1  |
| File0006 | File  | Full   | 1896460 | 2002-05-26 | 14400 | 1  |
| File0007 | File  | Purged | 1896466 | 2002-05-26 | 14400 | 1  |
+-----+-----+-----+-----+-----+-----+
    
```

In this case, **File0001** will never be automatically recycled. The same effect can be achieved by setting the Volume Status to Read-Only.

As you have noted, the Volume Status (VolStatus) column in the catalog database contains the current status of the Volume, which is normally maintained automatically by Bacula. To give you an idea of some of the values it can take during the life cycle of a Volume, here is a picture created by Arno Lehmann:

A typical volume life cycle is like this:

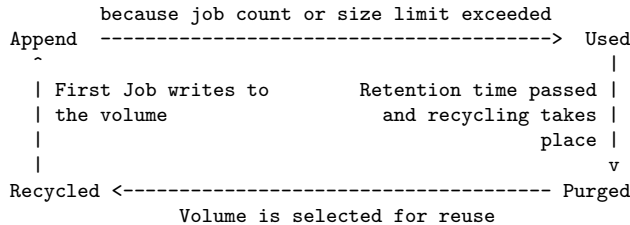

22.5 Making Bacula Use a Single Tape

Most people will want Bacula to fill a tape and when it is full, a new tape will be mounted, and so on. However, as an extreme example, it is possible for Bacula to write on a single tape, and every night to rewrite it. To get this to work, you must do two things: first, set the VolumeRetention to less than your save period (one day), and the second item is to make Bacula mark the tape as full after using it once. This is done using **UseVolumeOnce = yes**. If this latter record is not used and the tape is not full after the first time it is written, Bacula will simply append to the tape and eventually request another volume. Using



the tape only once, forces the tape to be marked **Full** after each use, and the next time **Bacula** runs, it will recycle the tape.

An example Pool resource that does this is:

```
Pool {
  Name = DDS-4
  Use Volume Once = yes
  Pool Type = Backup
  AutoPrune = yes
  VolumeRetention = 12h # expire after 12 hours
  Recycle = yes
}
```

22.6 Daily, Weekly, Monthly Tape Usage Example

This example is meant to show you how one could define a fixed set of volumes that Bacula will rotate through on a regular schedule. There are an infinite number of such schemes, all of which have various advantages and disadvantages.

We start with the following assumptions:

- A single tape has more than enough capacity to do a full save.
- There are ten tapes that are used on a daily basis for incremental backups. They are pre-labeled Daily1 ... Daily10.
- There are four tapes that are used on a weekly basis for full backups. They are labeled Week1 ... Week4.
- There are 12 tapes that are used on a monthly basis for full backups. They are numbered Month1 ... Month12
- A full backup is done every Saturday evening (tape inserted Friday evening before leaving work).
- No backups are done over the weekend (this is easy to change).
- The first Friday of each month, a Monthly tape is used for the Full backup.
- Incremental backups are done Monday - Friday (actually Tue-Fri mornings).

We start the system by doing a Full save to one of the weekly volumes or one of the monthly volumes. The next morning, we remove the tape and insert a Daily tape. Friday evening, we remove the Daily tape and insert the next tape in the Weekly series. Monday, we remove the Weekly tape and re-insert the Daily tape. On the first Friday of the next month, we insert the next Monthly tape in the series rather than a Weekly tape, then continue. When a Daily tape finally fills up, **Bacula** will request the next one in the series, and the next day when you notice the email message, you will mount it and **Bacula** will finish the unfinished incremental backup.

What does this give? Well, at any point, you will have the last complete Full save plus several Incremental saves. For any given file you want to recover (or your whole system), you will have a copy of that file every day for at least the last 14 days. For older versions, you will have at least three and probably four Friday full saves of that file, and going back further, you will have a copy of that file made on the beginning of the month for at least a year.

So you have copies of any file (or your whole system) for at least a year, but as you go back in time, the time between copies increases from daily to weekly to monthly.

What would the Bacula configuration look like to implement such a scheme?

```
Schedule {
  Name = "NightlySave"
  Run = Level=Full Pool=Monthly 1st sat at 03:05
  Run = Level=Full Pool=Weekly 2nd-5th sat at 03:05
  Run = Level=Incremental Pool=Daily tue-fri at 03:05
}
Job {
  Name = "NightlySave"
  Type = Backup
  Level = Full
  Client = LocalMachine
  FileSet = "File Set"
```



```

    Messages = Standard
    Storage = DDS-4
    Pool = Daily
    Schedule = "NightlySave"
}
# Definition of file storage device
Storage {
    Name = DDS-4
    Address = localhost
    SDPort = 9103
    Password = XXXXXXXXXXXXX
    Device = FileStorage
    Media Type = 8mm
}
FileSet {
    Name = "File Set"
    Include {
        Options { signature=MD5 }
        File = ffffffffffffffff
    }
    Exclude { File=*.o }
}
Pool {
    Name = Daily
    Pool Type = Backup
    AutoPrune = yes
    VolumeRetention = 10d # recycle in 10 days
    Maximum Volumes = 10
    Recycle = yes
}
Pool {
    Name = Weekly
    Use Volume Once = yes
    Pool Type = Backup
    AutoPrune = yes
    VolumeRetention = 30d # recycle in 30 days (default)
    Recycle = yes
}
Pool {
    Name = Monthly
    Use Volume Once = yes
    Pool Type = Backup
    AutoPrune = yes
    VolumeRetention = 365d # recycle in 1 year
    Recycle = yes
}
}

```

22.7 Automatic Pruning and Recycling Example

Perhaps the best way to understand the various resource records that come into play during automatic pruning and recycling is to run a Job that goes through the whole cycle. If you add the following resources to your Director's configuration file:

```

Schedule {
    Name = "30 minute cycle"
    Run = Level=Full Pool=File Messages=Standard Storage=File
        hourly at 0:05
    Run = Level=Full Pool=File Messages=Standard Storage=File
        hourly at 0:35
}
Job {
    Name = "Filetest"
    Type = Backup
    Level = Full
    Client=XXXXXXXXXX
    FileSet="Test Files"
    Messages = Standard
    Storage = File
    Pool = File
    Schedule = "30 minute cycle"
}
# Definition of file storage device
Storage {

```



```
Name = File
Address = XXXXXXXXXXXX
SDPort = 9103
Password = XXXXXXXXXXXX
Device = FileStorage
Media Type = File
}
FileSet {
  Name = "File Set"
  Include {
    Options { signature=MD5 }
    File = ffffffff
  }
  Exclude { File=*.o }
}
Pool {
  Name = File
  Use Volume Once = yes
  Pool Type = Backup
  LabelFormat = "File"
  AutoPrune = yes
  VolumeRetention = 4h
  Maximum Volumes = 12
  Recycle = yes
}
```

Where you will need to replace the `fffffff`'s by the appropriate files to be saved for your configuration. For the FileSet Include, choose a directory that has one or two megabytes maximum since there will probably be approximately eight copies of the directory that **Bacula** will cycle through.

In addition, you will need to add the following to your Storage daemon's configuration file:

```
Device {
  Name = FileStorage
  Media Type = File
  Archive Device = /tmp
  LabelMedia = yes;
  Random Access = Yes;
  AutomaticMount = yes;
  RemovableMedia = no;
  AlwaysOpen = no;
}
```

With the above resources, Bacula will start a Job every half hour that saves a copy of the directory you chose to `/tmp/File0001 ... /tmp/File0012`. After 4 hours, Bacula will start recycling the backup Volumes (`/tmp/File0001 ...`). You should see this happening in the output produced. Bacula will automatically create the Volumes (Files) the first time it uses them.

To turn it off, either delete all the resources you've added, or simply comment out the **Schedule** record in the **Job** resource.

22.8 Manually Recycling Volumes

Although automatic recycling of Volumes is implemented in version 1.20 and later (see the Automatic Recycling of Volumes chapter of this manual), you may want to manually force reuse (recycling) of a Volume. Assuming that you want to keep the Volume name, but you simply want to write new data on the tape, the steps to take are:

- Use the **update volume** command in the Console to ensure that the **Recycle** field is set to **1**
- Use the **purge jobs volume** command in the Console to mark the Volume as **Purged**. Check by using **list volumes**.

Once the Volume is marked Purged, it will be recycled the next time a Volume is needed.

If you wish to reuse the tape by giving it a new name, follow the following steps:

- Use the **purge jobs volume** command in the Console to mark the Volume as **Purged**. Check by using **list volumes**.
- In Bacula version 1.30 or greater, use the Console **relabel** command to relabel the Volume.



Please note that the **relabel** command applies only to tape Volumes.

For Bacula versions prior to 1.30 or to manually relabel the Volume, use the instructions below:

- Use the **delete volume** command in the Console to delete the Volume from the Catalog.
- If a different tape is mounted, use the **unmount** command, remove the tape, and insert the tape to be renamed.
- Write an EOF mark in the tape using the following commands:

```
mt -f /dev/nst0 rewind
mt -f /dev/nst0 weof
```

where you replace **/dev/nst0** with the appropriate device name on your system.

- Use the **label** command to write a new label to the tape and to enter it in the catalog.

Please be aware that the **delete** command can be dangerous. Once it is done, to recover the File records, you must either restore your database as it was before the **delete** command, or use the **bscan** utility program to scan the tape and recreate the database entries.





Chapter 23

Basic Volume Management

This chapter presents most all the features needed to do Volume management. Most of the concepts apply equally well to both tape and disk Volumes. However, the chapter was originally written to explain backing up to disk, so you will see it is slanted in that direction, but all the directives presented here apply equally well whether your volume is disk or tape.

If you have a lot of hard disk storage or you absolutely must have your backups run within a small time window, you may want to direct Bacula to backup to disk Volumes rather than tape Volumes. This chapter is intended to give you some of the options that are available to you so that you can manage either disk or tape volumes.

23.1 Key Concepts and Resource Records

Getting Bacula to write to disk rather than tape in the simplest case is rather easy. In the Storage daemon's configuration file, you simply define an **Archive Device** to be a directory. For example, if you want your disk backups to go into the directory `/home/bacula/backups`, you could use the following:

```
Device {
  Name = FileBackup
  Media Type = File
  Archive Device = /home/bacula/backups
  Random Access = Yes;
  AutomaticMount = yes;
  RemovableMedia = no;
  AlwaysOpen = no;
}
```

Assuming you have the appropriate **Storage** resource in your Director's configuration file that references the above Device resource,

```
Storage {
  Name = FileStorage
  Address = ...
  Password = ...
  Device = FileBackup
  Media Type = File
}
```

Bacula will then write the archive to the file `/home/bacula/backups/<volume-name>` where `<volume-name>` is the volume name of a Volume defined in the Pool. For example, if you have labeled a Volume named **Vol001**, Bacula will write to the file `/home/bacula/backups/Vol001`. Although you can later move the archive file to another directory, you should not rename it or it will become unreadable by Bacula. This is because each archive has the filename as part of the internal label, and the internal label must agree with the system filename before Bacula will use it.

Although this is quite simple, there are a number of problems. The first is that unless you specify otherwise, Bacula will always write to the same volume until you run out of disk space. This problem is addressed below.

In addition, if you want to use concurrent jobs that write to several different volumes at the same time, you will need to understand a number of other details. An example of such a configuration is given at the end of this chapter under Concurrent Disk Jobs.



23.1.1 Pool Options to Limit the Volume Usage

Some of the options you have, all of which are specified in the Pool record, are:

- To write each Volume only once (i.e. one Job per Volume or file in this case), use:

UseVolumeOnce = yes.

- To write nnn Jobs to each Volume, use:

Maximum Volume Jobs = nnn.

- To limit the maximum size of each Volume, use:

Maximum Volume Bytes = mmmm.

Note, if you use disk volumes, with all versions up to and including 1.39.28, you should probably limit the Volume size to some reasonable value such as say 5GB. This is because during a restore, Bacula is currently unable to seek to the proper place in a disk volume to restore a file, which means that it must read all records up to where the restore begins. If your Volumes are 50GB, reading half or more of the volume could take quite a bit of time. Also, if you ever have a partial hard disk failure, you are more likely to be able to recover more data if they are in smaller Volumes.

- To limit the use time (i.e. write the Volume for a maximum of five days), use:

Volume Use Duration = ttt.

Note that although you probably would not want to limit the number of bytes on a tape as you would on a disk Volume, the other options can be very useful in limiting the time Bacula will use a particular Volume (be it tape or disk). For example, the above directives can allow you to ensure that you rotate through a set of daily Volumes if you wish.

As mentioned above, each of those directives is specified in the Pool or Pools that you use for your Volumes. In the case of **Maximum Volume Job**, **Maximum Volume Bytes**, and **Volume Use Duration**, you can actually specify the desired value on a Volume by Volume basis. The value specified in the Pool record becomes the default when labeling new Volumes. Once a Volume has been created, it gets its own copy of the Pool defaults, and subsequently changing the Pool will have no effect on existing Volumes. You can either manually change the Volume values, or refresh them from the Pool defaults using the **update volume** command in the Console. As an example of the use of one of the above, suppose your Pool resource contains:

```
Pool {  
  Name = File  
  Pool Type = Backup  
  Volume Use Duration = 23h  
}
```

then if you run a backup once a day (every 24 hours), Bacula will use a new Volume for each backup, because each Volume it writes can only be used for 23 hours after the first write. Note, setting the use duration to 23 hours is not a very good solution for tapes unless you have someone on-site during the weekends, because Bacula will want a new Volume and no one will be present to mount it, so no weekend backups will be done until Monday morning.

23.1.2 Automatic Volume Labeling

Use of the above records brings up another problem – that of labeling your Volumes. For automated disk backup, you can either manually label each of your Volumes, or you can have Bacula automatically label new Volumes when they are needed. While, the automatic Volume labeling in version 1.30 and prior is a bit simplistic, but it does allow for automation, the features added in version 1.31 permit automatic creation of a wide variety of labels including information from environment variables and special Bacula Counter variables. In version 1.37 and later, it is probably much better to use Python scripting and the NewVolume event since generating Volume labels in a Python script is much easier than trying to figure out Counter variables. See the **Python Scripting** chapter (chapter 1 on page 1) of the Bacula Community Misc Manual details.

Please note that automatic Volume labeling can also be used with tapes, but it is not nearly so practical since the tapes must be pre-mounted. This requires some user interaction. Automatic labeling from templates does NOT work with autochangers since Bacula will not access unknown slots. There are several methods of labeling all volumes in an autochanger magazine. For more information on this, please see the Autochanger chapter of this manual.



Automatic Volume labeling is enabled by making a change to both the Pool resource (Director) and to the Device resource (Storage daemon) shown above. In the case of the Pool resource, you must provide Bacula with a label format that it will use to create new names. In the simplest form, the label format is simply the Volume name, to which Bacula will append a four digit number. This number starts at 0001 and is incremented for each Volume the catalog contains. Thus if you modify your Pool resource to be:

```
Pool {
  Name = File
  Pool Type = Backup
  Volume Use Duration = 23h
  LabelFormat = "Vol"
}
```

Bacula will create Volume names Vol0001, Vol0002, and so on when new Volumes are needed. Much more complex and elaborate labels can be created using variable expansion defined in the **Variable Expansion** chapter (chapter 2 on page 9) of the Bacula Community Misc Manual.

The second change that is necessary to make automatic labeling work is to give the Storage daemon permission to automatically label Volumes. Do so by adding **LabelMedia = yes** to the Device resource as follows:

```
Device {
  Name = File
  Media Type = File
  Archive Device = /home/bacula/backups
  Random Access = Yes;
  AutomaticMount = yes;
  RemovableMedia = no;
  AlwaysOpen = no;
  LabelMedia = yes
}
```

You can find more details of the **Label Format** Pool record in Label Format description of the Pool resource records.

23.1.3 Restricting the Number of Volumes and Recycling

Automatic labeling discussed above brings up the problem of Volume management. With the above scheme, a new Volume will be created every day. If you have not specified Retention periods, your Catalog will continue to fill keeping track of all the files Bacula has backed up, and this procedure will create one new archive file (Volume) every day.

The tools Bacula gives you to help automatically manage these problems are the following:

1. Catalog file record retention periods, the File Retention = ttt record in the Client resource.
2. Catalog job record retention periods, the Job Retention = ttt record in the Client resource.
3. The AutoPrune = yes record in the Client resource to permit application of the above two retention periods.
4. The Volume Retention = ttt record in the Pool resource.
5. The AutoPrune = yes record in the Pool resource to permit application of the Volume retention period.
6. The Recycle = yes record in the Pool resource to permit automatic recycling of Volumes whose Volume retention period has expired.
7. The Recycle Oldest Volume = yes record in the Pool resource tells Bacula to Prune the oldest volume in the Pool, and if all files were pruned to recycle this volume and use it.
8. The Recycle Current Volume = yes record in the Pool resource tells Bacula to Prune the currently mounted volume in the Pool, and if all files were pruned to recycle this volume and use it.
9. The Purge Oldest Volume = yes record in the Pool resource permits a forced recycling of the oldest Volume when a new one is needed. **N.B. This record ignores retention periods! We highly recommend not to use this record, but instead use Recycle Oldest Volume**
10. The Maximum Volumes = nnn record in the Pool resource to limit the number of Volumes that can be created.



The first three records (File Retention, Job Retention, and AutoPrune) determine the amount of time that Job and File records will remain in your Catalog, and they are discussed in detail in the Automatic Volume Recycling chapter of this manual.

Volume Retention, AutoPrune, and Recycle determine how long Bacula will keep your Volumes before reusing them, and they are also discussed in detail in the Automatic Volume Recycling chapter of this manual.

The Maximum Volumes record can also be used in conjunction with the Volume Retention period to limit the total number of archive Volumes (files) that Bacula will create. By setting an appropriate Volume Retention period, a Volume will be purged just before it is needed and thus Bacula can cycle through a fixed set of Volumes. Cycling through a fixed set of Volumes can also be done by setting **Recycle Oldest Volume = yes** or **Recycle Current Volume = yes**. In this case, when Bacula needs a new Volume, it will prune the specified volume.

23.2 Concurrent Disk Jobs

Above, we discussed how you could have a single device named **FileBackup** that writes to volumes in **/home/bacula/backups**. You can, in fact, run multiple concurrent jobs using the Storage definition given with this example, and all the jobs will simultaneously write into the Volume that is being written.

Now suppose you want to use multiple Pools, which means multiple Volumes, or suppose you want each client to have its own Volume and perhaps its own directory such as **/home/bacula/client1** and **/home/bacula/client2** ... With the single Storage and Device definition above, neither of these two is possible. Why? Because Bacula disk storage follows the same rules as tape devices. Only one Volume can be mounted on any Device at any time. If you want to simultaneously write multiple Volumes, you will need multiple Device resources in your bacula-sd.conf file, and thus multiple Storage resources in your bacula-dir.conf.

OK, so now you should understand that you need multiple Device definitions in the case of different directories or different Pools, but you also need to know that the catalog data that Bacula keeps contains only the Media Type and not the specific storage device. This permits a tape for example to be re-read on any compatible tape drive. The compatibility being determined by the Media Type. The same applies to disk storage. Since a volume that is written by a Device in say directory **/home/bacula/backups** cannot be read by a Device with an Archive Device definition of **/home/bacula/client1**, you will not be able to restore all your files if you give both those devices **Media Type = File**. During the restore, Bacula will simply choose the first available device, which may not be the correct one. If this is confusing, just remember that the Directory has only the Media Type and the Volume name. It does not know the **Archive Device** (or the full path) that is specified in the Storage daemon. Thus you must explicitly tie your Volumes to the correct Device by using the Media Type.

The example shown below shows a case where there are two clients, each using its own Pool and storing their Volumes in different directories.

23.3 An Example

The following example is not very practical, but can be used to demonstrate the proof of concept in a relatively short period of time. The example consists of a two clients that are backed up to a set of 12 archive files (Volumes) for each client into different directories on the Storage machine. Each Volume is used (written) only once, and there are four Full saves done every hour (so the whole thing cycles around after three hours).

What is key here is that each physical device on the Storage daemon has a different Media Type. This allows the Director to choose the correct device for restores ...

The Director's configuration file is as follows:

```
Director {
  Name = my-dir
  QueryFile = "~/bacula/bin/query.sql"
  PidDirectory = "~/bacula/working"
  WorkingDirectory = "~/bacula/working"
  Password = dir_password
}
Schedule {
  Name = "FourPerHour"
  Run = Level=Full hourly at 0:05
  Run = Level=Full hourly at 0:20
  Run = Level=Full hourly at 0:35
  Run = Level=Full hourly at 0:50
```



```
}
Job {
  Name = "RecycleExample"
  Type = Backup
  Level = Full
  Client = Rufus
  FileSet= "Example FileSet"
  Messages = Standard
  Storage = FileStorage
  Pool = Recycle
  Schedule = FourPerHour
}

Job {
  Name = "RecycleExample2"
  Type = Backup
  Level = Full
  Client = Roxie
  FileSet= "Example FileSet"
  Messages = Standard
  Storage = FileStorage1
  Pool = Recycle1
  Schedule = FourPerHour
}

FileSet {
  Name = "Example FileSet"
  Include {
    Options {
      compression=GZIP
      signature=SHA1
    }
    File = /home/kern/bacula/bin
  }
}

Client {
  Name = Rufus
  Address = rufus
  Catalog = BackupDB
  Password = client_password
}

Client {
  Name = Roxie
  Address = roxie
  Catalog = BackupDB
  Password = client1_password
}

Storage {
  Name = FileStorage
  Address = rufus
  Password = local_storage_password
  Device = RecycleDir
  Media Type = File
}

Storage {
  Name = FileStorage1
  Address = rufus
  Password = local_storage_password
  Device = RecycleDir1
  Media Type = File1
}

Catalog {
  Name = BackupDB
  dbname = bacula; user = bacula; password = ""
}

Messages {
  Name = Standard
  ...
}

Pool {
  Name = Recycle
```



```
Use Volume Once = yes
Pool Type = Backup
LabelFormat = "Recycle-"
AutoPrune = yes
VolumeRetention = 2h
Maximum Volumes = 12
Recycle = yes
}

Pool {
  Name = Recycle1
  Use Volume Once = yes
  Pool Type = Backup
  LabelFormat = "Recycle1-"
  AutoPrune = yes
  VolumeRetention = 2h
  Maximum Volumes = 12
  Recycle = yes
}
```

and the Storage daemon's configuration file is:

```
Storage {
  Name = my-sd
  WorkingDirectory = "~/bacula/working"
  Pid Directory = "~/bacula/working"
  MaximumConcurrentJobs = 10
}

Director {
  Name = my-dir
  Password = local_storage_password
}

Device {
  Name = RecycleDir
  Media Type = File
  Archive Device = /home/bacula/backups
  LabelMedia = yes;
  Random Access = Yes;
  AutomaticMount = yes;
  RemovableMedia = no;
  AlwaysOpen = no;
}

Device {
  Name = RecycleDir1
  Media Type = File1
  Archive Device = /home/bacula/backups1
  LabelMedia = yes;
  Random Access = Yes;
  AutomaticMount = yes;
  RemovableMedia = no;
  AlwaysOpen = no;
}

Messages {
  Name = Standard
  director = my-dir = all
}
```

With a little bit of work, you can change the above example into a weekly or monthly cycle (take care about the amount of archive disk space used).

23.4 Backing up to Multiple Disks

Bacula can, of course, use multiple disks, but in general, each disk must be a separate Device specification in the Storage daemon's conf file, and you must then select what clients to backup to each disk. You will also want to give each Device specification a different Media Type so that during a restore, Bacula will be able to find the appropriate drive.

The situation is a bit more complicated if you want to treat two different physical disk drives (or partitions) logically as a single drive, which Bacula does not directly support. However, it is possible to back up your



data to multiple disks as if they were a single drive by linking the Volumes from the first disk to the second disk.

For example, assume that you have two disks named `/disk1` and `/disk2`. If you then create a standard Storage daemon Device resource for backing up to the first disk, it will look like the following:

```
Device {
  Name = client1
  Media Type = File
  Archive Device = /disk1
  LabelMedia = yes;
  Random Access = Yes;
  AutomaticMount = yes;
  RemovableMedia = no;
  AlwaysOpen = no;
}
```

Since there is no way to get the above Device resource to reference both `/disk1` and `/disk2` we do it by pre-creating Volumes on `/disk2` with the following:

```
ln -s /disk2/Disk2-vol001 /disk1/Disk2-vol001
ln -s /disk2/Disk2-vol002 /disk1/Disk2-vol002
ln -s /disk2/Disk2-vol003 /disk1/Disk2-vol003
...
```

At this point, you can label the Volumes as Volume **Disk2-vol001**, **Disk2-vol002**, ... and Bacula will use them as if they were on `/disk1` but actually write the data to `/disk2`. The only minor inconvenience with this method is that you must explicitly name the disks and cannot use automatic labeling unless you arrange to have the labels exactly match the links you have created.

An important thing to know is that Bacula treats disks like tape drives as much as it can. This means that you can only have a single Volume mounted at one time on a disk as defined in your Device resource in the Storage daemon's conf file. You can have multiple concurrent jobs running that all write to the one Volume that is being used, but if you want to have multiple concurrent jobs that are writing to separate disks drives (or partitions), you will need to define separate Device resources for each one, exactly as you would do for two different tape drives. There is one fundamental difference, however. The Volumes that you create on the two drives cannot be easily exchanged as they can for a tape drive, because they are physically resident (already mounted in a sense) on the particular drive. As a consequence, you will probably want to give them different Media Types so that Bacula can distinguish what Device resource to use during a restore. An example would be the following:

```
Device {
  Name = Disk1
  Media Type = File1
  Archive Device = /disk1
  LabelMedia = yes;
  Random Access = Yes;
  AutomaticMount = yes;
  RemovableMedia = no;
  AlwaysOpen = no;
}

Device {
  Name = Disk2
  Media Type = File2
  Archive Device = /disk2
  LabelMedia = yes;
  Random Access = Yes;
  AutomaticMount = yes;
  RemovableMedia = no;
  AlwaysOpen = no;
}
```

With the above device definitions, you can run two concurrent jobs each writing at the same time, one to `/disk1` and the other to `/disk2`. The fact that you have given them different Media Types will allow Bacula to quickly choose the correct Storage resource in the Director when doing a restore.

23.5 Considerations for Multiple Clients

If we take the above example and add a second Client, here are a few considerations:



- Although the second client can write to the same set of Volumes, you will probably want to write to a different set.
- You can write to a different set of Volumes by defining a second Pool, which has a different name and a different **LabelFormat**.
- If you wish the Volumes for the second client to go into a different directory (perhaps even on a different filesystem to spread the load), you would do so by defining a second Device resource in the Storage daemon. The **Name** must be different, and the **Archive Device** could be different. To ensure that Volumes are never mixed from one pool to another, you might also define a different MediaType (e.g. **File1**).

In this example, we have two clients, each with a different Pool and a different number of archive files retained. They also write to different directories with different Volume labeling.

The Director's configuration file is as follows:

```
Director {
  Name = my-dir
  QueryFile = "~/bacula/bin/query.sql"
  PidDirectory = "~/bacula/working"
  WorkingDirectory = "~/bacula/working"
  Password = dir_password
}
# Basic weekly schedule
Schedule {
  Name = "WeeklySchedule"
  Run = Level=Full fri at 1:30
  Run = Level=Incremental sat-thu at 1:30
}
FileSet {
  Name = "Example FileSet"
  Include {
Options {
compression=GZIP
signature=SHA1
}
  File = /home/kern/bacula/bin
}
}
Job {
  Name = "Backup-client1"
  Type = Backup
  Level = Full
  Client = client1
  FileSet= "Example FileSet"
  Messages = Standard
  Storage = File1
  Pool = client1
  Schedule = "WeeklySchedule"
}
Job {
  Name = "Backup-client2"
  Type = Backup
  Level = Full
  Client = client2
  FileSet= "Example FileSet"
  Messages = Standard
  Storage = File2
  Pool = client2
  Schedule = "WeeklySchedule"
}
Client {
  Name = client1
  Address = client1
  Catalog = BackupDB
  Password = client1_password
  File Retention = 7d
}
Client {
  Name = client2
  Address = client2
  Catalog = BackupDB
  Password = client2_password
```



```

}
# Two Storage definitions with different Media Types
# permits different directories
Storage {
  Name = File1
  Address = rufus
  Password = local_storage_password
  Device = client1
  Media Type = File1
}
Storage {
  Name = File2
  Address = rufus
  Password = local_storage_password
  Device = client2
  Media Type = File2
}
Catalog {
  Name = BackupDB
  dbname = bacula; user = bacula; password = ""
}
Messages {
  Name = Standard
  ...
}
# Two pools permits different cycling periods and Volume names
# Cycle through 15 Volumes (two weeks)
Pool {
  Name = client1
  Use Volume Once = yes
  Pool Type = Backup
  LabelFormat = "Client1-"
  AutoPrune = yes
  VolumeRetention = 13d
  Maximum Volumes = 15
  Recycle = yes
}
# Cycle through 8 Volumes (1 week)
Pool {
  Name = client2
  Use Volume Once = yes
  Pool Type = Backup
  LabelFormat = "Client2-"
  AutoPrune = yes
  VolumeRetention = 6d
  Maximum Volumes = 8
  Recycle = yes
}

```

and the Storage daemon's configuration file is:

```

Storage {
  Name = my-sd
  WorkingDirectory = "~/bacula/working"
  Pid Directory = "~/bacula/working"
  MaximumConcurrentJobs = 10
}
Director {
  Name = my-dir
  Password = local_storage_password
}
# Archive directory for Client1
Device {
  Name = client1
  Media Type = File1
  Archive Device = /home/bacula/client1
  LabelMedia = yes;
  Random Access = Yes;
  AutomaticMount = yes;
  RemovableMedia = no;
  AlwaysOpen = no;
}
# Archive directory for Client2
Device {
  Name = client2
  Media Type = File2
}

```



```
Archive Device = /home/bacula/client2
LabelMedia = yes;
Random Access = Yes;
AutomaticMount = yes;
RemovableMedia = no;
AlwaysOpen = no;
}
Messages {
  Name = Standard
  director = my-dir = all
}
```



Chapter 24

Automated Disk Backup

If you manage five or ten machines and have a nice tape backup, you don't need Pools, and you may wonder what they are good for. In this chapter, you will see that Pools can help you optimize disk storage space. The same techniques can be applied to a shop that has multiple tape drives, or that wants to mount various different Volumes to meet their needs.

The rest of this chapter will give an example involving backup to disk Volumes, but most of the information applies equally well to tape Volumes.

24.1 The Problem

A site that I administer (a charitable organization) had a tape DDS-3 tape drive that was failing. The exact reason for the failure is still unknown. Worse yet, their full backup size is about 15GB whereas the capacity of their broken DDS-3 was at best 8GB (rated 6/12). A new DDS-4 tape drive and the necessary cassettes was more expensive than their budget could handle.

24.2 The Solution

They want to maintain six months of backup data, and be able to access the old files on a daily basis for a week, a weekly basis for a month, then monthly for six months. In addition, offsite capability was not needed (well perhaps it really is, but it was never used). Their daily changes amount to about 300MB on the average, or about 2GB per week.

As a consequence, the total volume of data they need to keep to meet their needs is about 100GB ($15\text{GB} \times 6 + 2\text{GB} \times 5 + 0.3 \times 7$) = 102.1GB.

The chosen solution was to buy a 120GB hard disk for next to nothing – far less than 1/10th the price of a tape drive and the cassettes to handle the same amount of data, and to have Bacula write to disk files.

The rest of this chapter will explain how to setup Bacula so that it would automatically manage a set of disk files with the minimum sysadmin intervention. The system has been running since 22 January 2004 until today (23 June 2007) with no intervention, with the exception of adding a second 120GB hard disk after a year because their needs grew over that time to more than the 120GB (168GB to be exact). The only other intervention I have made is a periodic (about once a year) Bacula upgrade.

24.3 Overall Design

Getting Bacula to write to disk rather than tape in the simplest case is rather easy, and is documented in the previous chapter. In addition, all the directives discussed here are explained in that chapter. We'll leave it to you to look at the details there. If you haven't read it and are not familiar with Pools, you probably should at least read it once quickly for the ideas before continuing here.

One needs to consider about what happens if we have only a single large Bacula Volume defined on our hard disk. Everything works fine until the Volume fills, then Bacula will ask you to mount a new Volume. This same problem applies to the use of tape Volumes if your tape fills. Being a hard disk and the only one you have, this will be a bit of a problem. It should be obvious that it is better to use a number of smaller Volumes and arrange for Bacula to automatically recycle them so that the disk storage space can be reused. The other problem with a single Volume, is that until version 2.0.0, Bacula did not seek within a disk Volume, so restoring a single file can take more time than one would expect.



As mentioned, the solution is to have multiple Volumes, or files on the disk. To do so, we need to limit the use and thus the size of a single Volume, by time, by number of jobs, or by size. Any of these would work, but we chose to limit the use of a single Volume by putting a single job in each Volume with the exception of Volumes containing Incremental backup where there will be 6 jobs (a week's worth of data) per volume. The details of this will be discussed shortly. This is a single client backup, so if you have multiple clients you will need to multiply those numbers by the number of clients, or use a different system for switching volumes, such as limiting the volume size.

The next problem to resolve is recycling of Volumes. As you noted from above, the requirements are to be able to restore monthly for 6 months, weekly for a month, and daily for a week. So to simplify things, why not do a Full save once a month, a Differential save once a week, and Incremental saves daily. Now since each of these different kinds of saves needs to remain valid for differing periods, the simplest way to do this (and possibly the only) is to have a separate Pool for each backup type.

The decision was to use three Pools: one for Full saves, one for Differential saves, and one for Incremental saves, and each would have a different number of volumes and a different Retention period to accomplish the requirements.

24.3.1 Full Pool

Putting a single Full backup on each Volume, will require six Full save Volumes, and a retention period of six months. The Pool needed to do that is:

```
Pool {
  Name = Full-Pool
  Pool Type = Backup
  Recycle = yes
  AutoPrune = yes
  Volume Retention = 6 months
  Maximum Volume Jobs = 1
  Label Format = Full-
  Maximum Volumes = 9
}
```

Since these are disk Volumes, no space is lost by having separate Volumes for each backup (done once a month in this case). The items to note are the retention period of six months (i.e. they are recycled after six months), that there is one job per volume (Maximum Volume Jobs = 1), the volumes will be labeled Full-0001, ... Full-0006 automatically. One could have labeled these manually from the start, but why not use the features of Bacula.

Six months after the first volume is used, it will be subject to pruning and thus recycling, so with a maximum of 9 volumes, there should always be 3 volumes available (note, they may all be marked used, but they will be marked purged and recycled as needed).

If you have two clients, you would want to set **Maximum Volume Jobs** to 2 instead of one, or set a limit on the size of the Volumes, and possibly increase the maximum number of Volumes.

24.3.2 Differential Pool

For the Differential backup Pool, we choose a retention period of a bit longer than a month and ensure that there is at least one Volume for each of the maximum of five weeks in a month. So the following works:

```
Pool {
  Name = Diff-Pool
  Pool Type = Backup
  Recycle = yes
  AutoPrune = yes
  Volume Retention = 40 days
  Maximum Volume Jobs = 1
  Label Format = Diff-
  Maximum Volumes = 10
}
```

As you can see, the Differential Pool can grow to a maximum of 9 volumes, and the Volumes are retained 40 days and thereafter they can be recycled. Finally there is one job per volume. This, of course, could be tightened up a lot, but the expense here is a few GB which is not too serious.

If a new volume is used every week, after 40 days, one will have used 7 volumes, and there should then always be 3 volumes that can be purged and recycled.

See the discussion above concerning the Full pool for how to handle multiple clients.



24.3.3 Incremental Pool

Finally, here is the resource for the Incremental Pool:

```
Pool {
  Name = Inc-Pool
  Pool Type = Backup
  Recycle = yes
  AutoPrune = yes
  Volume Retention = 20 days
  Maximum Volume Jobs = 6
  Label Format = Inc-
  Maximum Volumes = 7
}
```

We keep the data for 20 days rather than just a week as the needs require. To reduce the proliferation of volume names, we keep a week's worth of data (6 incremental backups) in each Volume. In practice, the retention period should be set to just a bit more than a week and keep only two or three volumes instead of five. Again, the lost is very little and as the system reaches the full steady state, we can adjust these values so that the total disk usage doesn't exceed the disk capacity.

If you have two clients, the simplest thing to do is to increase the maximum volume jobs from 6 to 12. As mentioned above, it is also possible limit the size of the volumes. However, in that case, you will need to have a better idea of the volume or add sufficient volumes to the pool so that you will be assured that in the next cycle (after 20 days) there is at least one volume that is pruned and can be recycled.

24.4 The Actual Conf Files

The following example shows you the actual files used, with only a few minor modifications to simplify things.

The Director's configuration file is as follows:

```
Director {          # define myself
  Name = bacula-dir
  DIRport = 9101
  QueryFile = "/home/bacula/bin/query.sql"
  WorkingDirectory = "/home/bacula/working"
  PidDirectory = "/home/bacula/working"
  Maximum Concurrent Jobs = 1
  Password = " *** CHANGE ME ***"
  Messages = Standard
}
# By default, this job will back up to disk in /tmp
Job {
  Name = client
  Type = Backup
  Client = client-fd
  FileSet = "Full Set"
  Schedule = "WeeklyCycle"
  Storage = File
  Messages = Standard
  Pool = Default
  Full Backup Pool = Full-Pool
  Incremental Backup Pool = Inc-Pool
  Differential Backup Pool = Diff-Pool
  Write Bootstrap = "/home/bacula/working/client.bsr"
  Priority = 10
}

# Backup the catalog database (after the nightly save)
Job {
  Name = "BackupCatalog"
  Type = Backup
  Client = client-fd
  FileSet="Catalog"
  Schedule = "WeeklyCycleAfterBackup"
  Storage = File
  Messages = Standard
  Pool = Default
  # This creates an ASCII copy of the catalog
  # WARNING!!! Passing the password via the command line is insecure.
  # see comments in make_catalog_backup for details.
```



```
RunBeforeJob = "/home/bacula/bin/make_catalog_backup bacula bacula"
# This deletes the copy of the catalog
RunAfterJob = "/home/bacula/bin/delete_catalog_backup"
Write Bootstrap = "/home/bacula/working/BackupCatalog.bsr"
Priority = 11 # run after main backup
}

# Standard Restore template, to be changed by Console program
Job {
  Name = "RestoreFiles"
  Type = Restore
  Client = havana-fd
  FileSet="Full Set"
  Storage = File
  Messages = Standard
  Pool = Default
  Where = /tmp/bacula-restores
}

# List of files to be backed up
FileSet {
  Name = "Full Set"
  Include { Options { signature=SHA1; compression=GZIP9 }
    File = /
    File = /usr
    File = /home
    File = /boot
    File = /var
    File = /opt
  }
  Exclude = {
    File = /proc
    File = /tmp
    File = /.journal
    File = /.fsck
    ...
  }
}

Schedule {
  Name = "WeeklyCycle"
  Run = Level=Full 1st sun at 2:05
  Run = Level=Differential 2nd-5th sun at 2:05
  Run = Level=Incremental mon-sat at 2:05
}

# This schedule does the catalog. It starts after the WeeklyCycle
Schedule {
  Name = "WeeklyCycleAfterBackup"
  Run = Level=Full sun-sat at 2:10
}

# This is the backup of the catalog
FileSet {
  Name = "Catalog"
  Include { Options { signature=MD5 }
    File = /home/bacula/working/bacula.sql
  }
}

Client {
  Name = client-fd
  Address = client
  FDPort = 9102
  Catalog = MyCatalog
  Password = " *** CHANGE ME ***"
  AutoPrune = yes # Prune expired Jobs/Files
  Job Retention = 6 months
  File Retention = 60 days
}

Storage {
  Name = File
  Address = localhost
  SDPort = 9103
}
```



```

Password = " *** CHANGE ME ***"
Device = FileStorage
Media Type = File
}

Catalog {
  Name = MyCatalog
  dbname = bacula; user = bacula; password = ""
}

Pool {
  Name = Full-Pool
  Pool Type = Backup
  Recycle = yes          # automatically recycle Volumes
  AutoPrune = yes       # Prune expired volumes
  Volume Retention = 6 months
  Maximum Volume Jobs = 1
  Label Format = Full-
  Maximum Volumes = 9
}

Pool {
  Name = Inc-Pool
  Pool Type = Backup
  Recycle = yes          # automatically recycle Volumes
  AutoPrune = yes       # Prune expired volumes
  Volume Retention = 20 days
  Maximum Volume Jobs = 6
  Label Format = Inc-
  Maximum Volumes = 7
}

Pool {
  Name = Diff-Pool
  Pool Type = Backup
  Recycle = yes
  AutoPrune = yes
  Volume Retention = 40 days
  Maximum Volume Jobs = 1
  Label Format = Diff-
  Maximum Volumes = 10
}

Messages {
  Name = Standard
  mailcommand = "bsmtp -h mail.domain.com -f \"\\(Bacula\\) %r\"
                -s \"Bacula: %t %e of %c %l\" %r"
  operatorcommand = "bsmtp -h mail.domain.com -f \"\\(Bacula\\) %r\"
                   -s \"Bacula: Intervention needed for %j\" %r"
  mail = root@domain.com = all, !skipped
  operator = root@domain.com = mount
  console = all, !skipped, !saved
  append = "/home/bacula/bin/log" = all, !skipped
}

```

and the Storage daemon's configuration file is:

```

Storage {
  # definition of myself
  Name = bacula-sd
  SDPort = 9103      # Director's port
  WorkingDirectory = "/home/bacula/working"
  Pid Directory = "/home/bacula/working"
}

Director {
  Name = bacula-dir
  Password = " *** CHANGE ME ***"
}

Device {
  Name = FileStorage
  Media Type = File
  Archive Device = /files/bacula
  LabelMedia = yes; # lets Bacula label unlabeled media
  Random Access = Yes;
  AutomaticMount = yes; # when device opened, read it
  RemovableMedia = no;
  AlwaysOpen = no;
}

```



```
}  
Messages {  
  Name = Standard  
  director = bacula-dir = all  
}
```



Chapter 25

Migration and Copy

The term Migration, as used in the context of Bacula, means moving data from one Volume to another. In particular it refers to a Job (similar to a backup job) that reads data that was previously backed up to a Volume and writes it to another Volume. As part of this process, the File catalog records associated with the first backup job are purged. In other words, Migration moves Bacula Job data from one Volume to another by reading the Job data from the Volume it is stored on, writing it to a different Volume in a different Pool, and then purging the database records for the first Job.

The Copy process is essentially identical to the Migration feature with the exception that the Job that is copied is left unchanged. This essentially creates two identical copies of the same backup. However, the copy is treated as a copy rather than a backup job, and hence is not directly available for restore. If bacula finds a copy when a job record is purged (deleted) from the catalog, it will promote the copy as *real* backup and will make it available for automatic restore.

The Copy and the Migration jobs run without using the File daemon by copying the data from the old backup Volume to a different Volume in a different Pool.

The selection process for which Job or Jobs are migrated can be based on quite a number of different criteria such as:

- a single previous Job
- a Volume
- a Client
- a regular expression matching a Job, Volume, or Client name
- the time a Job has been on a Volume
- high and low water marks (usage or occupation) of a Pool
- Volume size

The details of these selection criteria will be defined below.

To run a Migration job, you must first define a Job resource very similar to a Backup Job but with **Type = Migrate** instead of **Type = Backup**. One of the key points to remember is that the Pool that is specified for the migration job is the only pool from which jobs will be migrated, with one exception noted below. In addition, the Pool to which the selected Job or Jobs will be migrated is defined by the **Next Pool = ...** in the Pool resource specified for the Migration Job.

Bacula permits Pools to contain Volumes with different Media Types. However, when doing migration, this is a very undesirable condition. For migration to work properly, you should use Pools containing only Volumes of the same Media Type for all migration jobs.

The migration job normally is either manually started or starts from a Schedule much like a backup job. It searches for a previous backup Job or Jobs that match the parameters you have specified in the migration Job resource, primarily a **Selection Type** (detailed a bit later). Then for each previous backup JobId found, the Migration Job will run a new Job which copies the old Job data from the previous Volume to a new Volume in the Migration Pool. It is possible that no prior Jobs are found for migration, in which case, the Migration job will simply terminate having done nothing, but normally at a minimum, three jobs are involved during a migration:

- The currently running Migration control Job. This is only a control job for starting the migration child jobs.



- The previous Backup Job (already run). The File records for this Job are purged if the Migration job successfully terminates. The original data remains on the Volume until it is recycled and rewritten.
- A new Migration Backup Job that moves the data from the previous Backup job to the new Volume. If you subsequently do a restore, the data will be read from this Job.

If the Migration control job finds a number of JobIds to migrate (e.g. it is asked to migrate one or more Volumes), it will start one new migration backup job for each JobId found on the specified Volumes. Please note that Migration doesn't scale too well since Migrations are done on a Job by Job basis. This if you select a very large volume or a number of volumes for migration, you may have a large number of Jobs that start. Because each job must read the same Volume, they will run consecutively (not simultaneously).

25.1 Migration and Copy Job Resource Directives

The following directives can appear in a Director's Job resource, and they are used to define a Migration job.

Pool = <Pool-name> The Pool specified in the Migration control Job is not a new directive for the Job resource, but it is particularly important because it determines what Pool will be examined for finding JobIds to migrate. The exception to this is when **Selection Type = SQLQuery**, and although a Pool directive must still be specified, no Pool is used, unless you specifically include it in the SQL query. Note, in any case, the Pool resource defined by the Pool directive must contain a **Next Pool = ...** directive to define the Pool to which the data will be migrated.

Type = Migrate **Migrate** is a new type that defines the job that is run as being a Migration Job. A Migration Job is a sort of control job and does not have any Files associated with it, and in that sense they are more or less like an Admin job. Migration jobs simply check to see if there is anything to Migrate then possibly start and control new Backup jobs to migrate the data from the specified Pool to another Pool. Note, any original JobId that is migrated will be marked as having been migrated, and the original JobId can no longer be used for restores; all restores will be done from the new migrated Job.

Type = Copy **Copy** is a new type that defines the job that is run as being a Copy Job. A Copy Job is a sort of control job and does not have any Files associated with it, and in that sense they are more or less like an Admin job. Copy jobs simply check to see if there is anything to Copy then possibly start and control new Backup jobs to copy the data from the specified Pool to another Pool. Note that when a copy is made, the original JobIds are left unchanged. The new copies can not be used for restoration unless you specifically choose them by JobId. If you subsequently delete a JobId that has a copy, the copy will be automatically upgraded to a Backup rather than a Copy, and it will subsequently be used for restoration.

Selection Type = <Selection-type-keyword> The <Selection-type-keyword> determines how the migration job will go about selecting what JobIds to migrate. In most cases, it is used in conjunction with a **Selection Pattern** to give you fine control over exactly what JobIds are selected. The possible values for <Selection-type-keyword> are:

SmallestVolume This selection keyword selects the volume with the fewest bytes from the Pool to be migrated. The Pool to be migrated is the Pool defined in the Migration Job resource. The migration control job will then start and run one migration backup job for each of the Jobs found on this Volume. The Selection Pattern, if specified, is not used.

OldestVolume This selection keyword selects the volume with the oldest last write time in the Pool to be migrated. The Pool to be migrated is the Pool defined in the Migration Job resource. The migration control job will then start and run one migration backup job for each of the Jobs found on this Volume. The Selection Pattern, if specified, is not used.

Client The Client selection type, first selects all the Clients that have been backed up in the Pool specified by the Migration Job resource, then it applies the **Selection Pattern** (defined below) as a regular expression to the list of Client names, giving a filtered Client name list. All jobs that were backed up for those filtered (regexed) Clients will be migrated. The migration control job will then start and run one migration backup job for each of the JobIds found for those filtered Clients.

Volume The Volume selection type, first selects all the Volumes that have been backed up in the Pool specified by the Migration Job resource, then it applies the **Selection Pattern** (defined below) as a regular expression to the list of Volume names, giving a filtered Volume list. All JobIds that were backed up for those filtered (regexed) Volumes will be migrated. The migration control job will then start and run one migration backup job for each of the JobIds found on those filtered Volumes.

Job The Job selection type, first selects all the Jobs (as defined on the **Name** directive in a Job resource) that have been backed up in the Pool specified by the Migration Job resource, then it applies the **Selection Pattern** (defined below) as a regular expression to the list of Job names, giving a filtered Job name list. All JobIds that were run for those filtered (regexed) Job names will be migrated. Note, for a given Job named, they can be many jobs (JobIds) that ran. The migration control job will then start and run one migration backup job for each of the Jobs found.

SQLQuery The SQLQuery selection type, used the **Selection Pattern** as an SQL query to obtain the JobIds to be migrated. The Selection Pattern must be a valid SELECT SQL statement for your SQL engine, and it must return the JobId as the first field of the SELECT.

PoolOccupancy This selection type will cause the Migration job to compute the total size of the specified pool for all Media Types combined. If it exceeds the **Migration High Bytes** defined in the Pool, the Migration job will migrate all JobIds beginning with the oldest Volume in the pool (determined by Last Write time) until the Pool bytes drop below the **Migration Low Bytes** defined in the Pool. This calculation should be consider rather approximative because it is made once by the Migration job before migration is begun, and thus does not take into account additional data written into the Pool during the migration. In addition, the calculation of the total Pool byte size is based on the Volume bytes saved in the Volume (Media) database entries. The bytes calculate for Migration is based on the value stored in the Job records of the Jobs to be migrated. These do not include the Storage daemon overhead as is in the total Pool size. As a consequence, normally, the migration will migrate more bytes than strictly necessary.

PoolTime The PoolTime selection type will cause the Migration job to look at the time each JobId has been in the Pool since the job ended. All Jobs in the Pool longer than the time specified on **Migration Time** directive in the Pool resource will be migrated.

PoolUncopiedJobs This selection which copies all jobs from a pool to an other pool which were not copied before is available only for copy Jobs.

Selection Pattern = <Quoted-string> The Selection Patterns permitted for each Selection-type-keyword are described above.

For the OldestVolume and SmallestVolume, this Selection pattern is not used (ignored).

For the Client, Volume, and Job keywords, this pattern must be a valid regular expression that will filter the appropriate item names found in the Pool.

For the SQLQuery keyword, this pattern must be a valid SELECT SQL statement that returns JobIds.

Purge Migration Job = <yes/no> This directive may be added to the Migration Job definition in the Director configuration file to purge the job migrated at the end of a migration.

25.2 Migration Pool Resource Directives

The following directives can appear in a Director's Pool resource, and they are used to define a Migration job.

Migration Time = <time-specification> If a PoolTime migration is done, the time specified here in seconds (time modifiers are permitted – e.g. hours, ...) will be used. If the previous Backup Job or Jobs selected have been in the Pool longer than the specified PoolTime, then they will be migrated.

Migration High Bytes = <byte-specification> This directive specifies the number of bytes in the Pool which will trigger a migration if a **PoolOccupancy** migration selection type has been specified. The fact that the Pool usage goes above this level does not automatically trigger a migration job. However, if a migration job runs and has the PoolOccupancy selection type set, the Migration High Bytes will be applied. Bacula does not currently restrict a pool to have only a single Media Type, so you must keep in mind that if you mix Media Types in a Pool, the results may not be what you want, as the Pool count of all bytes will be for all Media Types combined.



Migration Low Bytes = <byte-specification> This directive specifies the number of bytes in the Pool which will stop a migration if a **PoolOccupancy** migration selection type has been specified and triggered by more than Migration High Bytes being in the pool. In other words, once a migration job is started with **PoolOccupancy** migration selection and it determines that there are more than Migration High Bytes, the migration job will continue to run jobs until the number of bytes in the Pool drop to or below Migration Low Bytes.

Next Pool = <pool-specification> The Next Pool directive specifies the pool to which Jobs will be migrated. This directive is required to define the Pool into which the data will be migrated. Without this directive, the migration job will terminate in error.

Storage = <storage-specification> The Storage directive specifies what Storage resource will be used for all Jobs that use this Pool. It takes precedence over any other Storage specifications that may have been given such as in the Schedule Run directive, or in the Job resource. We highly recommend that you define the Storage resource to be used in the Pool rather than elsewhere (job, schedule run, ...).

25.3 Important Migration Considerations

- Each Pool into which you migrate Jobs or Volumes **must** contain Volumes of only one Media Type.
- Migration takes place on a JobId by JobId basis. That is each JobId is migrated in its entirety and independently of other JobIds. Once the Job is migrated, it will be on the new medium in the new Pool, but for the most part, aside from having a new JobId, it will appear with all the same characteristics of the original job (start, end time, ...). The column RealEndTime in the catalog Job table will contain the time and date that the Migration terminated, and by comparing it with the EndTime column you can tell whether or not the job was migrated. The original job is purged of its File records, and its Type field is changed from "B" to "M" to indicate that the job was migrated.
- Jobs on Volumes will be Migration only if the Volume is marked, Full, Used, or Error. Volumes that are still marked Append will not be considered for migration. This prevents Bacula from attempting to read the Volume at the same time it is writing it. It also reduces other deadlock situations, as well as avoids the problem that you migrate a Volume and later find new files appended to that Volume.
- As noted above, for the Migration High Bytes, the calculation of the bytes to migrate is somewhat approximate.
- If you keep Volumes of different Media Types in the same Pool, it is not clear how well migration will work. We recommend only one Media Type per pool.
- It is possible to get into a resource deadlock where Bacula does not find enough drives to simultaneously read and write all the Volumes needed to do Migrations. For the moment, you must take care as all the resource deadlock algorithms are not yet implemented.
- Migration is done only when you run a Migration job. If you set a Migration High Bytes and that number of bytes is exceeded in the Pool no migration job will automatically start. You must schedule the migration jobs, and they must run for any migration to take place.
- If you migrate a number of Volumes, a very large number of Migration jobs may start.
- Figuring out what jobs will actually be migrated can be a bit complicated due to the flexibility provided by the regex patterns and the number of different options. Turning on a debug level of 100 or more will provide a limited amount of debug information about the migration selection process.
- Bacula currently does only minimal Storage conflict resolution, so you must take care to ensure that you don't try to read and write to the same device or Bacula may block waiting to reserve a drive that it will never find. In general, ensure that all your migration pools contain only one Media Type, and that you always migrate to pools with different Media Types.
- The **Next Pool = ...** directive must be defined in the Pool referenced in the Migration Job to define the Pool into which the data will be migrated.
- Pay particular attention to the fact that data is migrated on a Job by Job basis, and for any particular Volume, only one Job can read that Volume at a time (no simultaneous read), so migration jobs that all reference the same Volume will run sequentially. This can be a potential bottle neck and does not scale very well to large numbers of jobs.



- Only migration of Selection Types of Job and Volume have been carefully tested. All the other migration methods (time, occupancy, smallest, oldest, ...) need additional testing.
- Migration is only implemented for a single Storage daemon. You cannot read on one Storage daemon and write on another.

25.4 Example Migration Jobs

When you specify a Migration Job, you must specify all the standard directives as for a Job. However, certain such as the Level, Client, and FileSet, though they must be defined, are ignored by the Migration job because the values from the original job used instead.

As an example, suppose you have the following Job that you run every night. To note: there is no Storage directive in the Job resource; there is a Storage directive in each of the Pool resources; the Pool to be migrated (File) contains a Next Pool directive that defines the output Pool (where the data is written by the migration job).

```
# Define the backup Job
Job {
  Name = "NightlySave"
  Type = Backup
  Level = Incremental          # default
  Client=rufus-fd
  FileSet="Full Set"
  Schedule = "WeeklyCycle"
  Messages = Standard
  Pool = Default
}

# Default pool definition
Pool {
  Name = Default
  Pool Type = Backup
  AutoPrune = yes
  Recycle = yes
  Next Pool = Tape
  Storage = File
  LabelFormat = "File"
}

# Tape pool definition
Pool {
  Name = Tape
  Pool Type = Backup
  AutoPrune = yes
  Recycle = yes
  Storage = DLTDrive
}

# Definition of File storage device
Storage {
  Name = File
  Address = rufus
  Password = "ccV3lVTsQRsdIUGyab0N4sMDavui2h0BkmpBU0aQK0r9"
  Device = "File"             # same as Device in Storage daemon
  Media Type = File           # same as MediaType in Storage daemon
}

# Definition of DLT tape storage device
Storage {
  Name = DLTDrive
  Address = rufus
  Password = "ccV3lVTsQRsdIUGyab0N4sMDavui2h0BkmpBU0aQK0r9"
  Device = "HP DLT 80"        # same as Device in Storage daemon
  Media Type = DLT8000        # same as MediaType in Storage daemon
}
```

Where we have included only the essential information – i.e. the Director, FileSet, Catalog, Client, Schedule, and Messages resources are omitted.

As you can see, by running the NightlySave Job, the data will be backed up to File storage using the Default pool to specify the Storage as File.



Now, if we add the following Job resource to this conf file.

```
Job {
  Name = "migrate-volume"
  Type = Migrate
  Level = Full
  Client = rufus-fd
  FileSet = "Full Set"
  Messages = Standard
  Pool = Default
  Maximum Concurrent Jobs = 4
  Selection Type = Volume
  Selection Pattern = "File"
}
```

and then run the job named **migrate-volume**, all volumes in the Pool named Default (as specified in the migrate-volume Job that match the regular expression pattern **File** will be migrated to tape storage DLTDrive because the **Next Pool** in the Default Pool specifies that Migrations should go to the pool named **Tape**, which uses Storage **DLTDrive**.

If instead, we use a Job resource as follows:

```
Job {
  Name = "migrate"
  Type = Migrate
  Level = Full
  Client = rufus-fd
  FileSet="Full Set"
  Messages = Standard
  Pool = Default
  Maximum Concurrent Jobs = 4
  Selection Type = Job
  Selection Pattern = ".*Save"
}
```

All jobs ending with the name Save will be migrated from the File Default to the Tape Pool, or from File storage to Tape storage.



Chapter 26

File Deduplication using Base Jobs

A base job is sort of like a Full save except that you will want the FileSet to contain only files that are unlikely to change in the future (i.e. a snapshot of most of your system after installing it). After the base job has been run, when you are doing a Full save, you specify one or more Base jobs to be used. All files that have been backed up in the Base job/jobs but not modified will then be excluded from the backup. During a restore, the Base jobs will be automatically pulled in where necessary.

This is something none of the competition does, as far as we know (except perhaps BackupPC, which is a Perl program that saves to disk only). It is big win for the user, it makes Bacula stand out as offering a unique optimization that immediately saves time and money. Basically, imagine that you have 100 nearly identical Windows or Linux machine containing the OS and user files. Now for the OS part, a Base job will be backed up once, and rather than making 100 copies of the OS, there will be only one. If one or more of the systems have some files updated, no problem, they will be automatically restored.

A new Job directive `Base=Jobx, Joby...` permits to specify the list of files that will be used during Full backup as base.

```
Job {
    Name = BackupLinux
    Level= Base
    ...
}

Job {
    Name = BackupZog4
    Base = BackupZog4, BackupLinux
    Accurate = yes
    ...
}
```

In this example, the job `BackupZog4` will use the most recent version of all files contained in `BackupZog4` and `BackupLinux` jobs. Base jobs should have run with `level=Base` to be used.

By default, Bacula will compare permissions bits, user and group fields, modification time, size and the checksum of the file to choose between the current backup and the BaseJob file list. You can change this behavior with the `BaseJob FileSet` option. This option works like the `verify=` one, that is described in the FileSet chapter.

```
FileSet {
    Name = Full
    Include = {
        Options {
            BaseJob = pmugcs5
            Accurate = mcs
            Verify = pin5
        }
        File = /
    }
}
```



Important note: The current implementation doesn't permit to scan volume with **bscan**. The result wouldn't permit to restore files easily. It is recommended to not prune File or Job records with Basejobs.

Added in version 8.0.5, the new "M" option letter for the Accurate directive in the FileSet Options block, which allows comparing the modification time and/or creation time against the last backup timestamp. This is in contrast to the existing options letters "m" and/or "c", mtime and ctime, which are checked against the stored catalog values, that could vary accross different machines when using the BaseJob feature.

The advantage of the new "M" option letter for Jobs that refer to BaseJobs is that it will backup files based on the last backup time, which is more useful, because the mtime/ctime timestamps may differ on various Clients, causing unnecessary files to be backed up.

```
Job {
  Name = USR
  Level = Base
  FileSet = BaseFS
  ...
}

Job {
  Name = Full
  FileSet = FullFS
  Base = USR
  ...
}

FileSet {
  Name = BaseFS
  Include {
    Options {
      Signature = MD5
    }
    File = /usr
  }
}

FileSet {
  Name = FullFS
  Include {
    Options {
      Accurate = Ms      # check for mtime/ctime and Size
      Signature = MD5
    }
    File = /home
    File = /usr
  }
}
```



Chapter 27

Backup Strategies

Although Recycling and Backing Up to Disk Volume have been discussed in previous chapters, this chapter is meant to give you an overall view of possible backup strategies and to explain their advantages and disadvantages.

27.1 Simple One Tape Backup

Probably the simplest strategy is to back everything up to a single tape and insert a new (or recycled) tape when it fills and Bacula requests a new one.

27.1.1 Advantages

- The operator intervenes only when a tape change is needed. (once a month at my site).
- There is little chance of operator error because the tape is not changed daily.
- A minimum number of tapes will be needed for a full restore. Typically the best case will be one tape and worst two.
- You can easily arrange for the Full backup to occur a different night of the month for each system, thus load balancing and shortening the backup time.

27.1.2 Disadvantages

- If your site burns down, you will lose your current backups, and in my case about a month of data.
- After a tape fills and you have put in a blank tape, the backup will continue, and this will generally happen during working hours.

27.1.3 Practical Details

This system is very simple. When the tape fills and Bacula requests a new tape, you **unmount** the tape from the Console program, insert a new tape and **label** it. In most cases after the label, Bacula will automatically mount the tape and resume the backup. Otherwise, you simply **mount** the tape.

Using this strategy, one typically does a Full backup once a week followed by daily Incremental backups. To minimize the amount of data written to the tape, one can do a Full backup once a month on the first Sunday of the month, a Differential backup on the 2nd-5th Sunday of the month, and incremental backups the rest of the week.

27.2 Manually Changing Tapes

If you use the strategy presented above, Bacula will ask you to change the tape, and you will **unmount** it and then remount it when you have inserted the new tape.

If you do not wish to interact with Bacula to change each tape, there are several ways to get Bacula to release the tape:



- In your Storage daemon's Device resource, set **AlwaysOpen = no**. In this case, Bacula will release the tape after every job. If you run several jobs, the tape will be rewound and repositioned to the end at the beginning of every job. This is not very efficient, but does let you change the tape whenever you want.
- Use a **RunAfterJob** statement to run a script after your last job. This could also be an **Admin** job that runs after all your backup jobs. The script could be something like:

```
#!/bin/sh
/full-path/bconsole -c /full-path/bconsole.conf <<END_OF_DATA
release storage=your-storage-name
END_OF_DATA
```

In this example, you would have **AlwaysOpen=yes**, but the **release** command would tell Bacula to rewind the tape and on the next job assume the tape has changed. This strategy may not work on some systems, or on autochangers because Bacula will still keep the drive open.

- The final strategy is similar to the previous case except that you would use the **unmount** command to force Bacula to release the drive. Then you would eject the tape, and remount it as follows:

```
#!/bin/sh
/full-path/bconsole -c /full-path/bconsole.conf <<END_OF_DATA
unmount storage=your-storage-name
END_OF_DATA
# the following is a shell command
mt eject
/full-path/bconsole -c /full-path/bconsole.conf <<END_OF_DATA
mount storage=your-storage-name
END_OF_DATA
```

27.3 Daily Tape Rotation

This scheme is quite different from the one mentioned above in that a Full backup is done to a different tape every day of the week. Generally, the backup will cycle continuously through five or six tapes each week. Variations are to use a different tape each Friday, and possibly at the beginning of the month. Thus if backups are done Monday through Friday only, you need only five tapes, and by having two Friday tapes, you need a total of six tapes. Many sites run this way, or using modifications of it based on two week cycles or longer.

27.3.1 Advantages

- All the data is stored on a single tape, so recoveries are simple and faster.
- Assuming the previous day's tape is taken offsite each day, a maximum of one days data will be lost if the site burns down.

27.3.2 Disadvantages

- The tape must be changed every day requiring a lot of operator intervention.
- More errors will occur because of human mistakes.
- If the wrong tape is inadvertently mounted, the Backup for that day will not occur exposing the system to data loss.
- There is much more movement of the tape each day (rewinds) leading to shorter tape drive life time.
- Initial setup of Bacula to run in this mode is more complicated than the Single tape system described above.
- Depending on the number of systems you have and their data capacity, it may not be possible to do a Full backup every night for time reasons or reasons of tape capacity.



27.3.3 Practical Details

The simplest way to "force" Bacula to use a different tape each day is to define a different Pool for each day of the the week a backup is done. In addition, you will need to specify appropriate Job and File retention periods so that Bacula will relabel and overwrite the tape each week rather than appending to it. Nic Bellamy has supplied an actual working model of this which we include here.

What is important is to create a different Pool for each day of the week, and on the **run** statement in the Schedule, to specify which Pool is to be used. He has one Schedule that accomplishes this, and a second Schedule that does the same thing for the Catalog backup run each day after the main backup (Priorities were not available when this script was written). In addition, he uses a **Max Start Delay** of 22 hours so that if the wrong tape is premounted by the operator, the job will be automatically canceled, and the backup cycle will re-synchronize the next day. He has named his Friday Pool **WeeklyPool** because in that Pool, he wishes to have several tapes to be able to restore to a time older than one week.

And finally, in his Storage daemon's Device resource, he has **Automatic Mount = yes** and **Always Open = No**. This is necessary for the tape ejection to work in his **end_of_backup.sh** script below.

For example, his bacula-dir.conf file looks like the following:

```
# /etc/bacula/bacula-dir.conf
#
# Bacula Director Configuration file
#
Director {
  Name = ServerName
  DIRport = 9101
  QueryFile = "/etc/bacula/query.sql"
  WorkingDirectory = "/var/lib/bacula"
  PidDirectory = "/var/run"
  SubSysDirectory = "/var/lock/subsys"
  Maximum Concurrent Jobs = 1
  Password = "console-pass"
  Messages = Standard
}
#
# Define the main nightly save backup job
#
Job {
  Name = "NightlySave"
  Type = Backup
  Client = ServerName
  FileSet = "Full Set"
  Schedule = "WeeklyCycle"
  Storage = Tape
  Messages = Standard
  Pool = Default
  Write Bootstrap = "/var/lib/bacula/NightlySave.bsr"
  Max Start Delay = 22h
}
# Backup the catalog database (after the nightly save)
Job {
  Name = "BackupCatalog"
  Type = Backup
  Client = ServerName
  FileSet = "Catalog"
  Schedule = "WeeklyCycleAfterBackup"
  Storage = Tape
  Messages = Standard
  Pool = Default
  # This creates an ASCII copy of the catalog
  # WARNING!!! Passing the password via the command line is insecure.
  # see comments in make_catalog_backup for details.
  RunBeforeJob = "/usr/lib/bacula/make_catalog_backup -u bacula"
  # This deletes the copy of the catalog, and ejects the tape
  RunAfterJob = "/etc/bacula/end_of_backup.sh"
  Write Bootstrap = "/var/lib/bacula/BackupCatalog.bsr"
  Max Start Delay = 22h
}
# Standard Restore template, changed by Console program
Job {
  Name = "RestoreFiles"
  Type = Restore
  Client = ServerName
```



```
FileSet = "Full Set"
Storage = Tape
Messages = Standard
Pool = Default
Where = /tmp/bacula-restores
}
# List of files to be backed up
FileSet {
  Name = "Full Set"
  Include = signature=MD5 {
    /
    /data
  }
  Exclude = { /proc /tmp /.journal }
}
#
# When to do the backups
#
Schedule {
  Name = "WeeklyCycle"
  Run = Level=Full Pool=MondayPool Monday at 8:00pm
  Run = Level=Full Pool=TuesdayPool Tuesday at 8:00pm
  Run = Level=Full Pool=WednesdayPool Wednesday at 8:00pm
  Run = Level=Full Pool=ThursdayPool Thursday at 8:00pm
  Run = Level=Full Pool=WeeklyPool Friday at 8:00pm
}
# This does the catalog. It starts after the WeeklyCycle
Schedule {
  Name = "WeeklyCycleAfterBackup"
  Run = Level=Full Pool=MondayPool Monday at 8:15pm
  Run = Level=Full Pool=TuesdayPool Tuesday at 8:15pm
  Run = Level=Full Pool=WednesdayPool Wednesday at 8:15pm
  Run = Level=Full Pool=ThursdayPool Thursday at 8:15pm
  Run = Level=Full Pool=WeeklyPool Friday at 8:15pm
}
# This is the backup of the catalog
FileSet {
  Name = "Catalog"
  Include = signature=MD5 {
    /var/lib/bacula/bacula.sql
  }
}
# Client (File Services) to backup
Client {
  Name = ServerName
  Address = dionysus
  FDPort = 9102
  Catalog = MyCatalog
  Password = "client-pass"
  File Retention = 30d
  Job Retention = 30d
  AutoPrune = yes
}
# Definition of file storage device
Storage {
  Name = Tape
  Address = dionysus
  SDPort = 9103
  Password = "storage-pass"
  Device = Tandberg
  Media Type = MLR1
}
# Generic catalog service
Catalog {
  Name = MyCatalog
  dbname = bacula; user = bacula; password = ""
}
# Reasonable message delivery -- send almost all to email address
# and to the console
Messages {
  Name = Standard
  mailcommand = "/usr/sbin/bsmtp -h localhost -f \"\\(Bacula\\) %r\"
    -s \"Bacula: %t %e of %c %l\" %r"
  operatorcommand = "/usr/sbin/bsmtp -h localhost -f \"\\(Bacula\\) %r\"
    -s \"Bacula: Intervention needed for %j\" %r"
  mail = root@localhost = all, !skipped
}
```



```

operator = root@localhost = mount
console = all, !skipped, !saved
append = "/var/lib/bacula/log" = all, !skipped
}

# Pool definitions
#
# Default Pool for jobs, but will hold no actual volumes
Pool {
  Name = Default
  Pool Type = Backup
}
Pool {
  Name = MondayPool
  Pool Type = Backup
  Recycle = yes
  AutoPrune = yes
  Volume Retention = 6d
  Maximum Volume Jobs = 2
}
Pool {
  Name = TuesdayPool
  Pool Type = Backup
  Recycle = yes
  AutoPrune = yes
  Volume Retention = 6d
  Maximum Volume Jobs = 2
}
Pool {
  Name = WednesdayPool
  Pool Type = Backup
  Recycle = yes
  AutoPrune = yes
  Volume Retention = 6d
  Maximum Volume Jobs = 2
}
Pool {
  Name = ThursdayPool
  Pool Type = Backup
  Recycle = yes
  AutoPrune = yes
  Volume Retention = 6d
  Maximum Volume Jobs = 2
}
Pool {
  Name = WeeklyPool
  Pool Type = Backup
  Recycle = yes
  AutoPrune = yes
  Volume Retention = 12d
  Maximum Volume Jobs = 2
}
# EOF

```

Note, the mailcommand and operatorcommand should be on a single line each. They were split to preserve the proper page width. In order to get Bacula to release the tape after the nightly backup, he uses a **RunAfterJob** script that deletes the ASCII copy of the database back and then rewinds and ejects the tape. The following is a copy of **end_of_backup.sh**

```

#!/bin/sh
/usr/lib/bacula/delete_catalog_backup
mt rewind
mt eject
exit 0

```

Finally, if you list his Volumes, you get something like the following:

```

*list media
Using default Catalog name=MyCatalog DB=bacula
Pool: WeeklyPool
+-----+-----+-----+-----+-----+-----+-----+-----+
| MeId| VolumeName| MedTyp| VolStat| VolBytes | LastWritten | VolRet| Recycl|
+-----+-----+-----+-----+-----+-----+-----+-----+
| 5 | Friday_1 | MLR1 | Used | 2157171998| 2003-07-11 20:20| 103680| 1 |
| 6 | Friday_2 | MLR1 | Append | 0 | 0 | 103680| 1 |

```



```
+-----+-----+-----+-----+-----+-----+-----+-----+
Pool: MondayPool
+-----+-----+-----+-----+-----+-----+-----+-----+
| MeId| VolumeName| MedTyp| VolStat| VolBytes | LastWritten | VolRet| Recyc|
+-----+-----+-----+-----+-----+-----+-----+-----+
| 2 | Monday | MLR1 | Used | 2260942092| 2003-07-14 20:20| 518400| 1 |
+-----+-----+-----+-----+-----+-----+-----+-----+
Pool: TuesdayPool
+-----+-----+-----+-----+-----+-----+-----+-----+
| MeId| VolumeName| MedTyp| VolStat| VolBytes | LastWritten | VolRet| Recyc|
+-----+-----+-----+-----+-----+-----+-----+-----+
| 3 | Tuesday | MLR1 | Used | 2268180300| 2003-07-15 20:20| 518400| 1 |
+-----+-----+-----+-----+-----+-----+-----+-----+
Pool: WednesdayPool
+-----+-----+-----+-----+-----+-----+-----+-----+
| MeId| VolumeName| MedTyp| VolStat| VolBytes | LastWritten | VolRet| Recyc|
+-----+-----+-----+-----+-----+-----+-----+-----+
| 4 | Wednesday | MLR1 | Used | 2138871127| 2003-07-09 20:2 | 518400| 1 |
+-----+-----+-----+-----+-----+-----+-----+-----+
Pool: ThursdayPool
+-----+-----+-----+-----+-----+-----+-----+-----+
| MeId| VolumeName| MedTyp| VolStat| VolBytes | LastWritten | VolRet| Recyc|
+-----+-----+-----+-----+-----+-----+-----+-----+
| 1 | Thursday | MLR1 | Used | 2146276461| 2003-07-10 20:50| 518400| 1 |
+-----+-----+-----+-----+-----+-----+-----+-----+
Pool: Default
No results to list.
```

Note, I have truncated a number of the columns so that the information fits on the width of a page.



Chapter 28

Autochanger Support

Bacula provides autochanger support for reading and writing tapes. In order to work with an autochanger, Bacula requires a number of things, each of which is explained in more detail after this list:

- A script that actually controls the autochanger according to commands sent by Bacula. We furnish such a script that works with **mtx** found in the **depkgs** distribution.
- That each Volume (tape) to be used must be defined in the Catalog and have a Slot number assigned to it so that Bacula knows where the Volume is in the autochanger. This is generally done with the **label** command, but can also be done after the tape is labeled using the **update slots** command. See below for more details. You must pre-label the tapes manually before using them.
- Modifications to your Storage daemon's Device configuration resource to identify that the device is a changer, as well as a few other parameters.
- You should also modify your Storage resource definition in the Director's configuration file so that you are automatically prompted for the Slot when labeling a Volume.
- You need to ensure that your Storage daemon (if not running as root) has access permissions to both the tape drive and the control device.
- You need to have **Autochanger = yes** in your Storage resource in your bacula-dir.conf file so that you will be prompted for the slot number when you label Volumes.

In version 1.37 and later, there is a new Autochanger resource that permits you to group Device resources thus creating a multi-drive autochanger. If you have an autochanger, you **must** use this new resource.

Bacula uses its own **mtx-changer** script to interface with a program that actually does the tape changing. Thus in principle, **mtx-changer** can be adapted to function with any autochanger program, or you can call any other script or program. The current version of **mtx-changer** works with the **mtx** program. However, FreeBSD users have provided a script in the **examples/autochangers** directory that allows Bacula to use the **chio** program.

Bacula also supports autochangers with barcode readers. This support includes two Console commands: **label barcodes** and **update slots**. For more details on these commands, see the "Barcode Support" section below.

Current Bacula autochanger support does not include cleaning, stackers, or silos. Stackers and silos are not supported because Bacula expects to be able to access the Slots randomly. However, if you are very careful to setup Bacula to access the Volumes in the autochanger sequentially, you may be able to make Bacula work with stackers (gravity feed and such).

Support for multi-drive autochangers requires the Autochanger resource introduced in version 1.37. This resource is also recommended for single drive autochangers.

In principle, if **mtx** will operate your changer correctly, then it is just a question of adapting the **mtx-changer** script (or selecting one already adapted) for proper interfacing. You can find a list of autochangers supported by **mtx** at the following link: <http://mtx.opensource-sw.net/compatibility.php> . The home page for the **mtx** project can be found at: <http://mtx.opensource-sw.net/> .

Note, we have feedback from some users that there are certain incompatibilities between the Linux kernel and **mtx**. For example between kernel 2.6.18-8.1.8.el5 of CentOS and RedHat and version 1.3.10 and 1.3.11 of **mtx**. This was fixed by upgrading to a version 2.6.22 kernel.

In addition, apparently certain versions of **mtx**, for example, version 1.3.11 limit the number of slots to a maximum of 64. The solution was to use version 1.3.10.



If you are having troubles, please use the **auto** command in the **btape** program to test the functioning of your autochanger with Bacula. When Bacula is running, please remember that for many distributions (e.g. FreeBSD, Debian, ...) the Storage daemon runs as **bacula.tape** rather than **root.root**, so you will need to ensure that the Storage daemon has sufficient permissions to access the autochanger.

Some users have reported that the the Storage daemon blocks under certain circumstances in trying to mount a volume on a drive that has a different volume loaded. As best we can determine, this is simply a matter of waiting a bit. The drive was previously in use writing a Volume, and sometimes the drive will remain BLOCKED for a good deal of time (up to 7 minutes on a slow drive) waiting for the cassette to rewind and to unload before the drive can be used with a different Volume.

28.1 Knowing What SCSI Devices You Have

Under Linux, you can

```
cat /proc/scsi/scsi
```

to see what SCSI devices you have available. You can also:

```
cat /proc/scsi/sg/device_hdr /proc/scsi/sg/devices
```

to find out how to specify their control address (`/dev/sg0` for the first, `/dev/sg1` for the second, ...) on the **Changer Device =** Bacula directive.

You can also use the excellent **lsscsi** tool.

```
$ lsscsi -g
[1:0:2:0]   tape   SEAGATE  ULTRIUM06242-XXX 1619 /dev/st0 /dev/sg9
[1:0:14:0]  mediumx STK      L180           0315 /dev/sch0 /dev/sg10
[2:0:3:0]   tape   HP       Ultrium 3-SCSI  G24S /dev/st1 /dev/sg11
[3:0:0:0]   enclosu HP      A6255A        HP04  - /dev/sg3
[3:0:1:0]   disk   HP 36.4G ST336753FC    HP00  /dev/sdd /dev/sg4
```

For more detailed information on what SCSI devices you have please see the **Linux SCSI Tricks** section (section 3.2.2 on page 36) of the **Tape Testing** chapter (chapter 3 on page 31) of the Bacula Community Problem Resolution Guide.

Under FreeBSD, you can use:

```
camcontrol devlist
```

To list the SCSI devices as well as the `/dev/passn` that you will use on the Bacula **Changer Device =** directive.

Please check that your Storage daemon has permission to access this device.

The following tip for FreeBSD users comes from Danny Butroyd: on reboot Bacula will NOT have permission to control the device `/dev/pass0` (assuming this is your changer device). To get around this just edit the `/etc/devfs.conf` file and add the following to the bottom:

```
own   pass0   root:bacula
perm  pass0   0666
own   nsa0.0 root:bacula
perm  nsa0.0 0666
```

This gives the bacula group permission to write to the nsa0.0 device too just to be on the safe side. To bring these changes into effect just run:-

```
/etc/rc.d/devfs restart
```

Basically this will stop you having to manually change permissions on these devices to make Bacula work when operating the AutoChanger after a reboot.

28.2 Example Scripts

Please read the sections below so that you understand how autochangers work with Bacula. Although we supply a default **mtx-changer** script, your autochanger may require some additional changes. If you want to see examples of configuration files and scripts, please look in the `<bacula-src>/examples/devices` directory where you will find an example **HP-autoloader.conf** Bacula Device resource, and several **mtx-changer** scripts that have been modified to work with different autochangers.



28.3 Slots

To properly address autochangers, Bacula must know which Volume is in each **slot** of the autochanger. Slots are where the changer cartridges reside when not loaded into the drive. Bacula numbers these slots from one to the number of cartridges contained in the autochanger.

Bacula will not automatically use a Volume in your autochanger unless it is labeled and the slot number is stored in the catalog and the Volume is marked as InChanger. This is because it must know where each volume is (slot) to be able to load the volume. For each Volume in your changer, you will, using the Console program, assign a slot. This information is kept in **Bacula's** catalog database along with the other data for the volume. If no slot is given, or the slot is set to zero, Bacula will not attempt to use the autochanger even if all the necessary configuration records are present. When doing a **mount** command on an autochanger, you must specify which slot you want mounted. If the drive is loaded with a tape from another slot, it will unload it and load the correct tape, but normally, no tape will be loaded because an **unmount** command causes Bacula to unload the tape in the drive.

You can check if the Slot number and InChanger flag are set by doing a:

```
list Volumes
```

in the Console program.

28.4 Multiple Devices

Some autochangers have more than one read/write device (drive). The new Autochanger resource introduced in version 1.37 permits you to group Device resources, where each device represents a drive. The Director may still reference the Devices (drives) directly, but doing so, bypasses the proper functioning of the drives together. Instead, the Director (in the Storage resource) should reference the Autochanger resource name. Doing so permits the Storage daemon to ensure that only one drive uses the mtch-changer script at a time, and also that two drives don't reference the same Volume.

Multi-drive requires the use of the **Drive Index** directive in the Device resource of the Storage daemon's configuration file. Drive numbers or the Device Index are numbered beginning at zero, which is the default. To use the second Drive in an autochanger, you need to define a second Device resource and set the Drive Index to 1 for that device. In general, the second device will have the same **Changer Device** (control channel) as the first drive, but a different **Archive Device**.

As a default, Bacula jobs will prefer to write to a Volume that is already mounted. If you have a multiple drive autochanger and you want Bacula to write to more than one Volume in the same Pool at the same time, you will need to set Prefer Mounted Volumes in the Directors Job resource to **no**. This will cause the Storage daemon to maximize the use of drives.

28.5 Device Configuration Records

Configuration of autochangers within Bacula is done in the Device resource of the Storage daemon. Four records: **Autochanger**, **Changer Device**, **Changer Command**, and **Maximum Changer Wait** control how Bacula uses the autochanger.

These four records, permitted in **Device** resources, are described in detail below. Note, however, that the **Changer Device** and the **Changer Command** directives are not needed in the Device resource if they are present in the **Autochanger** resource.

Autochanger = *Yes—No* The **Autochanger** record specifies that the current device is or is not an autochanger. The default is **no**.

Changer Device = <device-name> In addition to the Archive Device name, you must specify a **Changer Device** name. This is because most autochangers are controlled through a different device than is used for reading and writing the cartridges. For example, on Linux, one normally uses the generic SCSI interface for controlling the autochanger, but the standard SCSI interface for reading and writing the tapes. On Linux, for the **Archive Device** = `/dev/nst0`, you would typically have **Changer Device** = `/dev/sg0`. Note, some of the more advanced autochangers will locate the changer device on `/dev/sg1`. Such devices typically have several drives and a large number of tapes.

On FreeBSD systems, the changer device will typically be on `/dev/pass0` through `/dev/passn`.

On Solaris, the changer device will typically be some file under `/dev/rdisk`.

Please ensure that your Storage daemon has permission to access this device.



Changer Command = `<command>` This record is used to specify the external program to call and what arguments to pass to it. The command is assumed to be a standard program or shell script that can be executed by the operating system. This command is invoked each time that Bacula wishes to manipulate the autochanger. The following substitutions are made in the **command** before it is sent to the operating system for execution:

```
%% = %
%a = archive device name
%c = changer device name
%d = changer drive index base 0
%f = Client's name
%j = Job name
%o = command (loaded, load, or unload)
%s = Slot base 0
%S = Slot base 1
%v = Volume name
```

An actual example for using **mtx** with the **mtx-changer** script (part of the Bacula distribution) is:

```
Changer Command = "/etc/bacula/mtx-changer %c %o %S %a %d"
```

Where you will need to adapt the `/etc/bacula` to be the actual path on your system where the `mtx-changer` script resides. Details of the three commands currently used by Bacula (loaded, load, unload) as well as the output expected by Bacula are give in the **Bacula Autochanger Interface** section below.

Maximum Changer Wait = `<time>` This record is used to define the maximum amount of time that Bacula will wait for an autoloader to respond to a command (e.g. load). The default is set to 120 seconds. If you have a slow autoloader you may want to set it longer.

If the autoloader program fails to respond in this time, it will be killed and Bacula will request operator intervention.

Drive Index = `<number>` This record allows you to tell Bacula to use the second or subsequent drive in an autochanger with multiple drives. Since the drives are numbered from zero, the second drive is defined by

```
Device Index = 1
```

To use the second drive, you need a second Device resource definition in the Bacula configuration file. See the Multiple Drive section above in this chapter for more information.

In addition, for proper functioning of the Autochanger, you must define an Autochanger resource.



Chapter 29

Autochanger Resource

The Autochanger resource supports single or multiple drive autochangers by grouping one or more Device resources into one unit called an autochanger in Bacula (often referred to as a "tape library" by autochanger manufacturers).

If you have an Autochanger, and you want it to function correctly, you **must** have an Autochanger resource in your Storage conf file, and your Director's Storage directives that want to use an Autochanger **must** refer to the Autochanger resource name. In previous versions of Bacula, the Director's Storage directives referred directly to Device resources that were autochangers. In version 1.38.0 and later, referring directly to Device resources will not work for Autochangers.

Name = <Autochanger-Name> Specifies the Name of the Autochanger. This name is used in the Director's Storage definition to refer to the autochanger. This directive is required.

Device = <Device-name1, device-name2, ...> Specifies the names of the Device resource or resources that correspond to the autochanger drive. If you have a multiple drive autochanger, you must specify multiple Device names, each one referring to a separate Device resource that contains a Drive Index specification that corresponds to the drive number base zero. You may specify multiple device names on a single line separated by commas, and/or you may specify multiple Device directives. This directive is required.

Changer Device = *name-string* The specified **name-string** gives the system file name of the autochanger device name. If specified in this resource, the Changer Device name is not needed in the Device resource. If it is specified in the Device resource (see above), it will take precedence over one specified in the Autochanger resource.

Changer Command = *name-string* The **name-string** specifies an external program to be called that will automatically change volumes as required by **Bacula**. Most frequently, you will specify the Bacula supplied **mtx-changer** script as follows. If it is specified here, it need not be specified in the Device resource. If it is also specified in the Device resource, it will take precedence over the one specified in the Autochanger resource.

The following is an example of a valid Autochanger resource definition:

```
Autochanger {
    Name = "DDS-4-changer"
    Device = DDS-4-1, DDS-4-2, DDS-4-3
    Changer Device = /dev/sg0
    Changer Command = "/etc/bacula/mtx-changer %c %o %S %a %d"
}
Device {
    Name = "DDS-4-1"
    Drive Index = 0
    Autochanger = yes
    ...
}
Device {
    Name = "DDS-4-2"
    Drive Index = 1
    Autochanger = yes
    ...
}
Device {
    Name = "DDS-4-3"
```



```

    Drive Index = 2
    Autochanger = yes
    Autoselect = no
    ...
}

```

Please note that it is important to include the **Autochanger = yes** directive in each Device definition that belongs to an Autochanger. A device definition should not belong to more than one Autochanger resource. Also, your Device directive in the Storage resource of the Director's conf file should have the Autochanger's resource name rather than a name of one of the Devices.

If you have a drive that physically belongs to an Autochanger but you don't want to have it automatically used when Bacula references the Autochanger for backups, for example, you want to reserve it for restores, you can add the directive:

```
Autoselect = no
```

to the Device resource for that drive. In that case, Bacula will not automatically select that drive when accessing the Autochanger. You can, still use the drive by referencing it by the Device name directly rather than the Autochanger name. An example of such a definition is shown above for the Device DDS-4-3, which will not be selected when the name DDS-4-changer is used in a Storage definition, but will be used if DDS-4-3 is used.

29.1 An Example Configuration File

The following two resources implement an autochanger:

```

Autochanger {
    Name = "Autochanger"
    Device = DDS-4
    Changer Device = /dev/sg0
    Changer Command = "/etc/bacula/mtx-changer %c %o %S %a %d"
}

Device {
    Name = DDS-4
    Media Type = DDS-4
    Archive Device = /dev/nst0    # Normal archive device
    Autochanger = yes
    LabelMedia = no;
    AutomaticMount = yes;
    AlwaysOpen = yes;
}

```

where you will adapt the **Archive Device**, the **Changer Device**, and the path to the **Changer Command** to correspond to the values used on your system.

29.2 A Multi-drive Example Configuration File

The following resources implement a multi-drive autochanger:

```

Autochanger {
    Name = "Autochanger"
    Device = Drive-1, Drive-2
    Changer Device = /dev/sg0
    Changer Command = "/etc/bacula/mtx-changer %c %o %S %a %d"
}

Device {
    Name = Drive-1
    Drive Index = 0
    Media Type = DDS-4
    Archive Device = /dev/nst0    # Normal archive device
    Autochanger = yes
    LabelMedia = no;
    AutomaticMount = yes;
    AlwaysOpen = yes;
}

Device {

```



```
Name = Drive-2
Drive Index = 1
Media Type = DDS-4
Archive Device = /dev/nst1    # Normal archive device
Autochanger = yes
LabelMedia = no;
AutomaticMount = yes;
AlwaysOpen = yes;
}
```

where you will adapt the **Archive Device**, the **Changer Device**, and the path to the **Changer Command** to correspond to the values used on your system.

29.3 Specifying Slots When Labeling

If you add an **Autochanger = yes** record to the Storage resource in your Director's configuration file, the Bacula Console will automatically prompt you for the slot number when the Volume is in the changer when you **add** or **label** tapes for that Storage device. If your **mtx-changer** script is properly installed, Bacula will automatically load the correct tape during the label command.

You must also set **Autochanger = yes** in the Storage daemon's Device resource as we have described above in order for the autochanger to be used. Please see the Storage Resource in the Director's chapter and the Device Resource in the Storage daemon chapter for more details on these records.

Thus all stages of dealing with tapes can be totally automated. It is also possible to set or change the Slot using the **update** command in the Console and selecting **Volume Parameters** to update.

Even though all the above configuration statements are specified and correct, Bacula will attempt to access the autochanger only if a **slot** is non-zero in the catalog Volume record (with the Volume name).

If your autochanger has barcode labels, you can label all the Volumes in your autochanger one after another by using the **label barcodes** command. For each tape in the changer containing a barcode, Bacula will mount the tape and then label it with the same name as the barcode. An appropriate Media record will also be created in the catalog. Any barcode that begins with the same characters as specified on the "CleaningPrefix=xxx" command, will be treated as a cleaning tape, and will not be labeled. For example with:

Please note that Volumes must be pre-labeled to be automatically used in the autochanger during a backup. If you do not have a barcode reader, this is done manually (or via a script).

```
Pool {
  Name ...
  Cleaning Prefix = "CLN"
}
```

Any slot containing a barcode of CLNxxxx will be treated as a cleaning tape and will not be mounted.

29.4 Changing Cartridges

If you wish to insert or remove cartridges in your autochanger or you manually run the **mtx** program, you must first tell Bacula to release the autochanger by doing:

```
unmount
(change cartridges and/or run mtx)
mount
```

If you do not do the unmount before making such a change, Bacula will become completely confused about what is in the autochanger and may stop function because it expects to have exclusive use of the autochanger while it has the drive mounted.

29.5 Dealing with Multiple Magazines

If you have several magazines or if you insert or remove cartridges from a magazine, you should notify Bacula of this. By doing so, Bacula will as a preference, use Volumes that it knows to be in the autochanger before accessing Volumes that are not in the autochanger. This prevents unneeded operator intervention.

If your autochanger has barcodes (machine readable tape labels), the task of informing Bacula is simple. Every time, you change a magazine, or add or remove a cartridge from the magazine, simply do



```

unmount
(remove magazine)
(insert new magazine)
update slots
mount

```

in the Console program. This will cause Bacula to request the autochanger to return the current Volume names in the magazine. This will be done without actually accessing or reading the Volumes because the barcode reader does this during inventory when the autochanger is first turned on. Bacula will ensure that any Volumes that are currently marked as being in the magazine are marked as no longer in the magazine, and the new list of Volumes will be marked as being in the magazine. In addition, the Slot numbers of the Volumes will be corrected in Bacula's catalog if they are incorrect (added or moved).

If you do not have a barcode reader on your autochanger, you have several alternatives.

1. You can manually set the Slot and InChanger flag using the **update volume** command in the Console (quite painful).
2. You can issue a

```
update slots scan
```

command that will cause Bacula to read the label on each of the cartridges in the magazine in turn and update the information (Slot, InChanger flag) in the catalog. This is quite effective but does take time to load each cartridge into the drive in turn and read the Volume label.

3. You can modify the `mtx-changer` script so that it simulates an autochanger with barcodes. See below for more details.

29.6 Simulating Barcodes in your Autochanger

You can simulate barcodes in your autochanger by making the **mtx-changer** script return the same information that an autochanger with barcodes would do. This is done by commenting out the one and only line in the **list**) case, which is:

```

${MTX} -f $ctl status | grep " *Storage Element [0-9]*:.*Full" | awk "{print \$3 \$4}" | sed "s/Full *\(:(VolumeTag=\\)*//"

```

at approximately line 99 by putting a `#` in column one of that line, or by simply deleting it. Then in its place add a new line that prints the contents of a file. For example:

```
cat /etc/bacula/changer.volumes
```

Be sure to include a full path to the file, which can have any name. The contents of the file must be of the following format:

```

1:Volume1
2:Volume2
3:Volume3
...

```

Where the 1, 2, 3 are the slot numbers and Volume1, Volume2, ... are the Volume names in those slots. You can have multiple files that represent the Volumes in different magazines, and when you change magazines, simply copy the contents of the correct file into your `/etc/bacula/changer.volumes` file. There is no need to stop and start Bacula when you change magazines, simply put the correct data in the file, then run the **update slots** command, and your autochanger will appear to Bacula to be an autochanger with barcodes.

29.7 The Full Form of the Update Slots Command

If you change only one cartridge in the magazine, you may not want to scan all Volumes, so the **update slots** command (as well as the **update slots scan** command) has the additional form:

```
update slots=n1,n2,n3-n4, ...
```



where the keyword **scan** can be appended or not. The n1,n2, ... represent Slot numbers to be updated and the form n3-n4 represents a range of Slot numbers to be updated (e.g. 4-7 will update Slots 4,5,6, and 7). This form is particularly useful if you want to do a scan (time expensive) and restrict the update to one or two slots.

For example, the command:

```
update slots=1,6 scan
```

will cause Bacula to load the Volume in Slot 1, read its Volume label and update the Catalog. It will do the same for the Volume in Slot 6. The command:

```
update slots=1-3,6
```

will read the barcoded Volume names for slots 1,2,3 and 6 and make the appropriate updates in the Catalog. If you don't have a barcode reader or have not modified the `mtx-changer` script as described above, the above command will not find any Volume names so will do nothing.

29.8 FreeBSD Issues

If you are having problems on FreeBSD when Bacula tries to select a tape, and the message is **Device not configured**, this is because FreeBSD has made the tape device `/dev/nsa1` disappear when there is no tape mounted in the autochanger slot. As a consequence, Bacula is unable to open the device. The solution to the problem is to make sure that some tape is loaded into the tape drive before starting Bacula. This problem is corrected in Bacula versions 1.32f-5 and later.

Please see the **Tape Testing** chapter (chapter 3.3.6 on page 41) of the Bacula Community Problem Resolution Guide for **important** information concerning your tape drive before doing the autochanger testing.

29.9 Testing Autochanger and Adapting `mtx-changer` script

Before attempting to use the autochanger with Bacula, it is preferable to "hand-test" that the changer works. To do so, we suggest you do the following commands (assuming that the `mtx-changer` script is installed in `/etc/bacula/mtx-changer`):

Make sure Bacula is not running.

```
/etc/bacula/mtx-changer /dev/sg0 list 0 /dev/nst0 0
```

 This command should print:

```
1:
2:
3:
...
```

or one number per line for each slot that is occupied in your changer, and the number should be terminated by a colon (:). If your changer has barcodes, the barcode will follow the colon. If an error message is printed, you must resolve the problem (e.g. try a different SCSI control device name if `/dev/sg0` is incorrect). For example, on FreeBSD systems, the autochanger SCSI control device is generally `/dev/pass2`.

```
/etc/bacula/mtx-changer /dev/sg0 listall 0 /dev/nst0 0
```

 This command should print:

```
Drive content:          D:Drive num:F:Slot loaded:Volume Name
D:0:F:2:vol12          or D:Drive num:E
D:1:F:42:vol142
D:3:E
```

```
Slot content:
S:1:F:vol1             S:Slot num:F:Volume Name
S:2:E                  or S:Slot num:E
S:3:F:vol14
```

```
Import/Export tray slots:
I:10:F:vol110         I:Slot num:F:Volume Name
I:11:E                or I:Slot num:E
I:12:F:vol140
```



`/etc/bacula/mtx-changer /dev/sg0 transfer 1 2` This command should transfer a volume from source (1) to destination (2)

`/etc/bacula/mtx-changer /dev/sg0 slots` This command should return the number of slots in your autochanger.

`/etc/bacula/mtx-changer /dev/sg0 unload 1 /dev/nst0 0` If a tape is loaded from slot 1, this should cause it to be unloaded.

`/etc/bacula/mtx-changer /dev/sg0 load 3 /dev/nst0 0` Assuming you have a tape in slot 3, it will be loaded into drive (0).

`/etc/bacula/mtx-changer /dev/sg0 loaded 0 /dev/nst0 0` It should print "3" Note, we have used an "illegal" slot number 0. In this case, it is simply ignored because the slot number is not used. However, it must be specified because the drive parameter at the end of the command is needed to select the correct drive.

`/etc/bacula/mtx-changer /dev/sg0 unload 3 /dev/nst0 0` will unload the tape into slot 3.

Once all the above commands work correctly, assuming that you have the right **Changer Command** in your configuration, Bacula should be able to operate the changer. The only remaining area of problems will be if your autoloader needs some time to get the tape loaded after issuing the command. After the **mtx-changer** script returns, Bacula will immediately rewind and read the tape. If Bacula gets rewind I/O errors after a tape change, you will probably need to insert a **sleep 20** after the **mtx** command, but be careful to exit the script with a zero status by adding **exit 0** after any additional commands you add to the script. This is because Bacula checks the return status of the script, which should be zero if all went well. You can test whether or not you need a **sleep** by putting the following commands into a file and running it as a script:

```
#!/bin/sh
/etc/bacula/mtx-changer /dev/sg0 unload 1 /dev/nst0 0
/etc/bacula/mtx-changer /dev/sg0 load 3 /dev/nst0 0
mt -f /dev/st0 rewind
mt -f /dev/st0 weof
```

If the above script runs, you probably have no timing problems. If it does not run, start by putting a **sleep 30** or possibly a **sleep 60** in the script just after the **mtx-changer** load command. If that works, then you should move the sleep into the actual **mtx-changer** script so that it will be effective when Bacula runs.

A second problem that comes up with a small number of autochangers is that they need to have the cartridge ejected before it can be removed. If this is the case, the **load 3** will never succeed regardless of how long you wait. If this seems to be your problem, you can insert an **eject** just after the **unload** so that the script looks like:

```
#!/bin/sh
/etc/bacula/mtx-changer /dev/sg0 unload 1 /dev/nst0 0
mt -f /dev/st0 offline
/etc/bacula/mtx-changer /dev/sg0 load 3 /dev/nst0 0
mt -f /dev/st0 rewind
mt -f /dev/st0 weof
```

Obviously, if you need the **offline** command, you should move it into the **mtx-changer** script ensuring that you save the status of the **mtx** command or always force an **exit 0** from the script, because Bacula checks the return status of the script.

As noted earlier, there are several scripts in `<bacula-source>/examples/devices` that implement the above features, so they may be a help to you in getting your script to work.

If Bacula complains "Rewind error on /dev/nst0. ERR=Input/output error." you most likely need more sleep time in your **mtx-changer** before returning to Bacula after a load command has been completed.

29.10 Using the Autochanger

Let's assume that you have properly defined the necessary Storage daemon Device records, and you have added the **Autochanger = yes** record to the Storage resource in your Director's configuration file.

Now you fill your autochanger with say six blank tapes.

What do you do to make Bacula access those tapes?

One strategy is to prelabel each of the tapes. Do so by starting Bacula, then with the Console program, enter the **label** command:



```
./bconsole
Connecting to Director rufus:8101
1000 OK: rufus-dir Version: 1.26 (4 October 2002)
*label
```

it will then print something like:

```
Using default Catalog name=BackupDB DB=bacula
The defined Storage resources are:
    1: Autochanger
    2: File
Select Storage resource (1-2): 1
```

I select the autochanger (1), and it prints:

```
Enter new Volume name: TestVolume1
Enter slot (0 for none): 1
```

where I entered **TestVolume1** for the tape name, and slot **1** for the slot. It then asks:

```
Defined Pools:
    1: Default
    2: File
Select the Pool (1-2): 1
```

I select the Default pool. This will be automatically done if you only have a single pool, then Bacula will proceed to unload any loaded volume, load the volume in slot 1 and label it. In this example, nothing was in the drive, so it printed:

```
Connecting to Storage daemon Autochanger at localhost:9103 ...
Sending label command ...
3903 Issuing autochanger "load slot 1" command.
3000 OK label. Volume=TestVolume1 Device=/dev/nst0
Media record for Volume=TestVolume1 successfully created.
Requesting mount Autochanger ...
3001 Device /dev/nst0 is mounted with Volume TestVolume1
You have messages.
*
```

You may then proceed to label the other volumes. The messages will change slightly because Bacula will unload the volume (just labeled TestVolume1) before loading the next volume to be labeled.

Once all your Volumes are labeled, Bacula will automatically load them as they are needed.

To "see" how you have labeled your Volumes, simply enter the **list volumes** command from the Console program, which should print something like the following:

```
*{\bf list volumes}
Using default Catalog name=BackupDB DB=bacula
Defined Pools:
    1: Default
    2: File
Select the Pool (1-2): 1
+-----+-----+-----+-----+-----+-----+-----+-----+-----+
| MedId | VolName | MedTyp | VolStat | Bites | LstWrt | VolReten | Recyc | Slot |
+-----+-----+-----+-----+-----+-----+-----+-----+-----+
| 1     | TestVol1 | DDS-4  | Append  | 0     | 0     | 30672000 | 0     | 1     |
| 2     | TestVol2 | DDS-4  | Append  | 0     | 0     | 30672000 | 0     | 2     |
| 3     | TestVol3 | DDS-4  | Append  | 0     | 0     | 30672000 | 0     | 3     |
| ...   |          |        |         |       |       |          |       |       |
+-----+-----+-----+-----+-----+-----+-----+-----+-----+
```

29.11 Barcode Support

Bacula provides barcode support with two Console commands, **label barcodes** and **update slots**.

The **label barcodes** will cause Bacula to read the barcodes of all the cassettes that are currently installed in the magazine (cassette holder) using the **mtx-changer list** command. Each cassette is mounted in turn and labeled with the same Volume name as the barcode.

The **update slots** command will first obtain the list of cassettes and their barcodes from **mtx-changer**. Then it will find each volume in turn in the catalog database corresponding to the barcodes and set its Slot to correspond to the value just read. If the Volume is not in the catalog, then nothing will be done. This



command is useful for synchronizing Bacula with the current magazine in case you have changed magazines or in case you have moved cassettes from one slot to another. If the autochanger is empty, nothing will be done.

The **Cleaning Prefix** statement can be used in the Pool resource to define a Volume name prefix, which if it matches that of the Volume (barcode) will cause that Volume to be marked with a VolStatus of **Cleaning**. This will prevent Bacula from attempting to write on the Volume.

29.12 Use bconsole to display Autochanger content

The **status slots storage=xxx** command displays autochanger content.

Slot	Volume Name	Status	Type	Pool	Loaded
1	00001	Append	DiskChangerMedia	Default	0
2	00002	Append	DiskChangerMedia	Default	0
3*	00003	Append	DiskChangerMedia	Scratch	0
4					0

If you see a * near the slot number, you have to run **update slots** command to synchronize autochanger content with your catalog.

29.13 Bacula Autochanger Interface

Bacula calls the autochanger script that you specify on the **Changer Command** statement. Normally this script will be the **mtx-changer** script that we provide, but it can in fact be any program. The only requirement for the script is that it must understand the commands that Bacula uses, which are **loaded**, **load**, **unload**, **list**, and **slots**. In addition, each of those commands must return the information in the precise format as specified below:

- Currently the changer commands used are:
 - loaded** -- returns number of the slot that is loaded, base 1, in the drive or 0 if the drive is empty.
 - load** -- loads a specified slot (note, some autochangers require a 30 second pause after this command) into the drive.
 - unload** -- unloads the device (returns cassette to its slot).
 - list** -- returns one line for each cassette in the autochanger in the format <slot>:<barcode>. Where the **{\bf slot}** is the non-zero integer representing the slot number, and **{\bf barcode}** is the barcode associated with the cassette if it exists and if you autoloader supports barcodes. Otherwise the barcode field is blank.
 - slots** -- returns total number of slots in the autochanger.

Bacula checks the exit status of the program called, and if it is zero, the data is accepted. If the exit status is non-zero, Bacula will print an error message and request the tape be manually mounted on the drive.



Chapter 30

Supported Autochangers

I hesitate to call these "supported" autochangers because the only autochangers that I have in my possession and am able to test are the HP SureStore DAT40X6 and the Overland PowerLoader LTO-2. All the other autochangers have been reported to work by Bacula users. Note, in the Capacity/Slot column below, I quote the Compressed capacity per tape (or Slot).

Since on most systems (other than FreeBSD), Bacula uses **mtx** through the **mtx-changer** script, in principle, if **mtx** will operate your changer correctly, then it is just a question of adapting the **mtx-changer** script (or selecting one already adapted) for proper interfacing. You can find a list of autochangers supported by **mtx** at the following link: <http://mtx.opensource-sw.net/compatibility.php> . The home page for the **mtx** project can be found at: <http://mtx.opensource-sw.net/> .

O.S.	Man.	Media	Model	Slots	Cap / Slot
Linux	Adic	DDS-3	Adic 1200G	12	—
Linux	Adic	DLT	FastStore 4000	7	20GB
Linux	Adic	LTO-1/2, SDLT 320	Adic Scalar 24	24	100GB
Linux	Adic	LTO-2	Adic FastStor 2, Sun Storedge L8	8	200GB
Linux	BDT	AIT	BDT ThinStor	?	200GB
—	CA-VM	??	Tape	??	??
Linux	Dell	DLT VI,LTO- 2,LTO3	PowerVault 122T/132T/136T	—	100GB
Linux	Dell	LTO-2	PowerVault 124T	—	200GB
—	DFSMS	??	VM RMM	—	??
Linux	Exabyte	VXA2	VXA Packet- Loader 1x10 2U	10	80/160GB
—	Exabyte	LTO	Magnum 1x7 LTO Tape Auotloader	7	200/400GB
Linux	Exabyte	AIT-2	215A	15 (2 drives)	50GB
Linux	HP	DDS-4	SureStore DAT- 40X6	6	40GB
Linux	HP	Ultrium- 2/LTO	MSL 6000/ 60030/ 5052	28	200/400GB
—	HP	DLT	A4853 DLT	30	40/70GB



O.S.	Man.	Media	Model	Slots	Cap / Slot
Linux	HP (Compaq)	DLT VI	Compaq TL-895	96+4 import export	35/70GB
z/VM	IBM	??	IBM Tape Manager	—	??
z/VM	IBM	??	native tape	—	??
Linux	IBM	LTO	IBM 3581 Ultrium Tape Loader	7	200/400GB
FreeBSD 5.4	IBM	DLT	IBM 3502-R14 – rebranded ATL L-500	14	35/70GB
Linux	IBM	???	IBM TotalStorage 3582L23	??	??
Debian	Overland	LTO	Overland LoaderXpress LTO/DLT8000	10-19	40-100GB
Fedora	Overland	LTO	Overland PowerLoader LTO-2	10-19	200/400GB
FreeBSD 5.4-Stable	Overland	LTO-2	Overland Powerloader tape	17	100GB
—	Overland	LTO	Overland Neo2000 LTO	26-30	100GB
Linux	Quantum	DLT-S4	Superloader 3	16	800/1600GB
Linux	Quantum	LTO-2	Superloader 3	16	200/400GB
Linux	Quantum	LTO-3	PX502	??	??
FreeBSD 4.9	QUALSTAR TLS-4210 (Qualstar)	AIT1: 36GB, AIT2: 50GB all uncomp	QUALSTAR TLS-4210	12	AIT1: 36GB, AIT2: 50GB all uncomp
Linux	Skydata	DLT	ATL-L200	8	40/80
-	Sony	DDS-4	TSL-11000	8	40GB
Linux	Sony	AIT-2	LIB-304(SDX-500C)	?	200GB
Linux	Sony	AIT-3	LIB-D81)	?	200GB
FreeBSD 4.9-STABLE	Sony	AIT-1	TSL-SA300C	4	45/70GB
—	Storagetek	DLT	Timberwolf DLT	6	40/70
—	Storagetek	??	ACSL5	??	??
Solaris	Sun	4mm DLT	Sun Desktop Archive Python 29279	4	20GB
Linux	Tandberg	DLT VI	VS 640	8?	35/70GB
Linux 2.6.x	Tandberg Data	SLR100	SLR100 Autoloader	8	50/100GB



Chapter 31

Data Spooling

Bacula allows you to specify that you want the Storage daemon to initially write your data to disk and then subsequently to tape. This serves several important purposes.

- It takes a long time for data to come in from the File daemon during an Incremental backup. If it is directly written to tape, the tape will start and stop or shoe-shine as it is often called causing tape wear. By first writing the data to disk, then writing it to tape, the tape can be kept in continual motion.
- While the spooled data is being written to the tape, the despooling process has exclusive use of the tape. This means that you can spool multiple simultaneous jobs to disk, then have them very efficiently despoiled one at a time without having the data blocks from several jobs intermingled, thus substantially improving the time needed to restore files. While despooling, all jobs spooling continue running.
- Writing to a tape can be slow. By first spooling your data to disk, you can often reduce the time the File daemon is running on a system, thus reducing downtime, and/or interference with users. Of course, if your spool device is not large enough to hold all the data from your File daemon, you may actually slow down the overall backup.

Data spooling is exactly that "spooling". It is not a way to first write a "backup" to a disk file and then to a tape. When the backup has only been spooled to disk, it is not complete yet and cannot be restored until it is written to tape.

Bacula version 1.39.x and later supports writing a backup to disk then later **Migrating** or moving it to a tape (or any other medium). For details on this, please see the Migration chapter of this manual for more details.

The remainder of this chapter explains the various directives that you can use in the spooling process.

31.1 Data Spooling Directives

The following directives can be used to control data spooling.

- To turn data spooling on/off at the Job level in the Job resource in the Director's conf file (default **no**).
SpoolData = yes|no
- To override the Job specification in a Schedule Run directive in the Director's conf file.
SpoolData = yes|no
- To override the Job specification in a bconsole session using the **run** command. Please note that this does **not** refer to a configuration statement, but to an argument for the run command.
SpoolData=yes|no
- To limit the the maximum spool file size for a particular job in the Job resource
Spool Size = size Where size is a the maximum spool size for this job specified in bytes.



- To limit the maximum total size of the spooled data for a particular device. Specified in the Device resource of the Storage daemon's conf file (default unlimited).

Maximum Spool Size = size Where size is the maximum spool size for all jobs specified in bytes.

- To limit the maximum total size of the spooled data for a particular device for a single job. Specified in the Device Resource of the Storage daemon's conf file (default unlimited).

Maximum Job Spool Size = size Where size is the maximum spool file size for a single job specified in bytes.

- To specify the spool directory for a particular device. Specified in the Device Resource of the Storage daemon's conf file (default, the working directory).

Spool Directory = directory

31.2 !!! MAJOR WARNING !!!

Please be very careful to exclude the spool directory from any backup, otherwise, your job will write enormous amounts of data to the Volume, and most probably terminate in error. This is because in attempting to backup the spool file, the backup data will be written a second time to the spool file, and so on ad infinitum. Another advice is to always specify the maximum spool size so that your disk doesn't completely fill up. In principle, data spooling will properly detect a full disk, and despool data allowing the job to continue. However, attribute spooling is not so kind to the user. If the disk on which attributes are being spooled fills, the job will be canceled. In addition, if your working directory is on the same partition as the spool directory, then Bacula jobs will fail possibly in bizarre ways when the spool fills.

31.3 Other Points

- When data spooling is enabled, Bacula automatically turns on attribute spooling. In other words, it also spools the catalog entries to disk. This is done so that in case the job fails, there will be no catalog entries pointing to non-existent tape backups.
- Attribute despooling occurs near the end of a job. The Storage daemon accumulates file attributes during the backup and sends them to the Director at the end of the job. The Director then inserts the file attributes into the catalog. During this insertion, the tape drive may be inactive. When the file attribute insertion is completed, the job terminates.
- Attribute spool files are always placed in the working directory of the Storage daemon.
- When Bacula begins despooling data spooled to disk, it takes exclusive use of the tape. This has the major advantage that in running multiple simultaneous jobs at the same time, the blocks of several jobs will not be intermingled.
- It probably does not make a lot of sense to enable data spooling if you are writing to disk files.
- It is probably best to provide as large a spool file as possible to avoid repeatedly spooling/despooling. Also, while a job is despooling to tape, the File daemon must wait (i.e. spooling stops for the job while it is despooling).
- If you are running multiple simultaneous jobs, Bacula will continue spooling other jobs while one is despooling to tape, provided there is sufficient spool file space.



Chapter 32

Using Bacula catalog to grab information

Bacula catalog contains lot of information about your IT infrastructure, how many files, their size, the number of video or music files etc. Using Bacula catalog during the day to get them permit to save resources on your servers.

In this chapter, you will find tips and information to measure bacula efficiency and report statistics.

32.1 Job statistics

If you (or probably your boss) want to have statistics on your backups to provide some *Service Level Agreement* indicators, you could use a few SQL queries on the Job table to report how many:

- jobs have run
- jobs have been successful
- files have been backed up
- ...

However, these statistics are accurate only if your job retention is greater than your statistics period. Ie, if jobs are purged from the catalog, you won't be able to use them.

Now, you can use the **update stats [days=num]** console command to fill the JobHistory table with new Job records. If you want to be sure to take in account only **good jobs**, ie if one of your important job has failed but you have fixed the problem and restarted it on time, you probably want to delete the first *bad* job record and keep only the successful one. For that simply let your staff do the job, and update JobHistory table after two or three days depending on your organization using the **[days=num]** option.

These statistics records aren't used for restoring, but mainly for capacity planning, billings, etc.

The Bweb interface provides a statistics module that can use this feature. You can also use tools like Talend or extract information by yourself.

The **Statistics Retention = <time>** director directive defines the length of time that Bacula will keep statistics job records in the Catalog database after the Job End time. (In JobHistory table) When this time period expires, and if user runs **prune stats** command, Bacula will prune (remove) Job records that are older than the specified period.

You can use the following Job resource in your nightly **BackupCatalog** job to maintain statistics.

```
Job {
  Name = BackupCatalog
  ...
  RunScript {
    Console = "update stats days=3"
    Console = "prune stats yes"
    RunsWhen = After
    RunsOnClient = no
  }
}
```





Chapter 33

ANSI and IBM Tape Labels

Bacula supports ANSI or IBM tape labels as long as you enable it. In fact, with the proper configuration, you can force Bacula to require ANSI or IBM labels.

Bacula can create an ANSI or IBM label, but if Check Labels is enabled (see below), Bacula will look for an existing label, and if it is found, it will keep the label. Consequently, you can label the tapes with programs other than Bacula, and Bacula will recognize and support them.

Even though Bacula will recognize and write ANSI and IBM labels, it always writes its own tape labels as well.

When using ANSI or IBM tape labeling, you must restrict your Volume names to a maximum of six characters.

If you have labeled your Volumes outside of Bacula, then the ANSI/IBM label will be recognized by Bacula only if you have created the HDR1 label with **BACULA.DATA** in the Filename field (starting with character 5). If Bacula writes the labels, it will use this information to recognize the tape as a Bacula tape. This allows ANSI/IBM labeled tapes to be used at sites with multiple machines and multiple backup programs.

33.1 Director Pool Directive

Label Type = ANSI — IBM — Bacula This directive is implemented in the Director Pool resource and in the SD Device resource. If it is specified in the SD Device resource, it will take precedence over the value passed from the Director to the SD. The default is Label Type = Bacula.

33.2 Storage Daemon Device Directives

Label Type = ANSI — IBM — Bacula This directive is implemented in the Director Pool resource and in the SD Device resource. If it is specified in the the SD Device resource, it will take precedence over the value passed from the Director to the SD.

Check Labels = yes — no This directive is implemented in the the SD Device resource. If you intend to read ANSI or IBM labels, this **must** be set. Even if the volume is not ANSI labeled, you can set this to yes, and Bacula will check the label type. Without this directive set to yes, Bacula will assume that labels are of Bacula type and will not check for ANSI or IBM labels. In other words, if there is a possibility of Bacula encountering an ANSI/IBM label, you must set this to yes.





Chapter 34

The Windows Version of Bacula

At the current time only the File daemon or Client program has been thoroughly tested on Windows and is suitable for a production environment. As a consequence, when we speak of the Windows version of Bacula below, we are referring to the File daemon (client) only.

The Windows version of the Bacula File daemon has been tested on WinXP, Win2000, Windows Server 2003, Windows Server 2008, Vista, Windows 7, and Windows 8 systems. The Windows version of Bacula is a native Windows port, but there are very few source code changes to the Unix code, which means that the Windows version is for the most part running code that has long proved stable on Unix systems. When running, it is perfectly integrated with Windows and displays its icon in the system icon tray, and provides a system tray menu to obtain additional information on how Bacula is running (status and events dialog boxes). If so desired, it can also be stopped by using the system tray menu, though this should normally never be necessary.

Once installed Bacula normally runs as a system service. This means that it is immediately started by the operating system when the system is booted, and runs in the background even if there is no user logged into the system.

34.1 Windows Installation

Normally, you will install the Windows version of Bacula from the binaries. This install is standard Windows .exe that runs an install wizard using the NSIS Free Software installer, so if you have already installed Windows software, it should be very familiar to you.

If you have a previous version of Bacula installed, you should stop the service, uninstall it, and remove the Bacula installation directory possibly saving your bacula-fd.conf, bconsole.conf, and bat.conf files for use with the new version you will install. The Uninstall program is normally found in `c:\bacula\Uninstall.exe`. We also recommend that you completely remove the directory `c:\bacula`, because the current installer uses a different directory structure (see below).

Providing you do not already have Bacula installed, the installer installs the binaries and dlls in `c:\Program Files\Bacula\bin` and the configuration files in `c:\Documents and Settings\All Users\Application Data\Bacula`. In addition, the **Start>All Programs>Bacula** menu item will be created during the installation, and on that menu, you will find items for editing the configuration files, displaying the document, and starting `bwx-console` or `bconsole`.

Finally, proceed with the installation.

- You must be logged in as Administrator to the local machine to do a correct installation, if not, please do so before continuing. Some users have attempted to install logged in as a domain administrator account and experienced permissions problems attempting to run Bacula, so we don't recommend that option.
- Simply double click on the `bacula-win32-5.xx.0.exe` NSIS install icon. The actual name of the icon will vary from one release version to another.



bacula-win32-5.xx.0.exe

- Once launched, the installer wizard will ask you if you want to install Bacula.

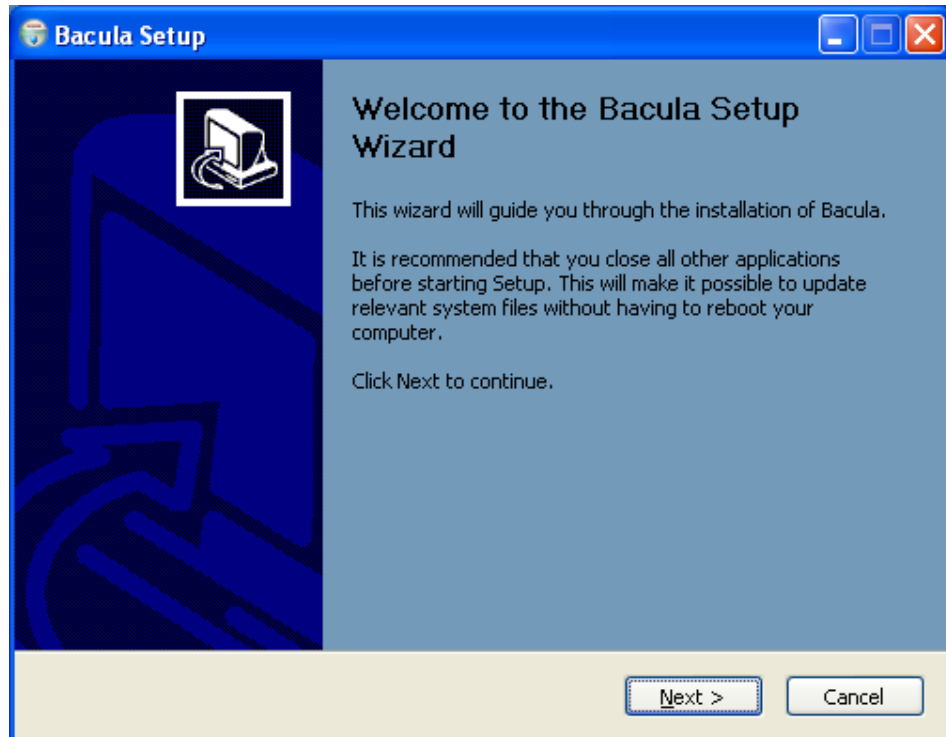

- Next you will be asked to select the installation type.

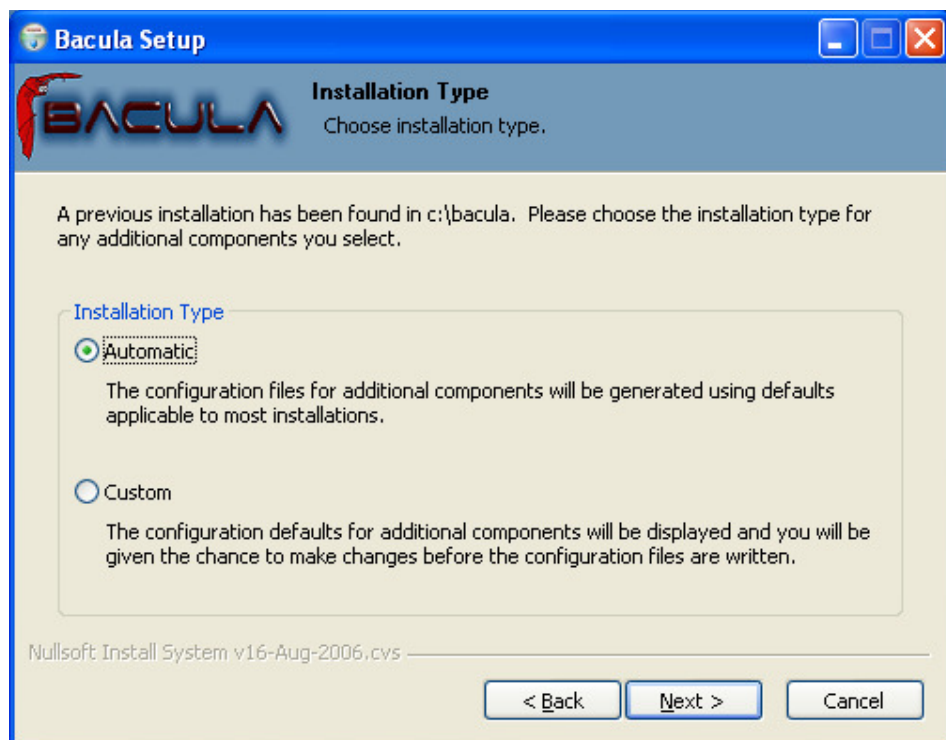

- If you proceed, you will be asked to select the components to be installed. You may install the Bacula program (Bacula File Service) and or the documentation. Both will be installed in sub-directories of the install location that you choose later. The components dialog looks like the following:

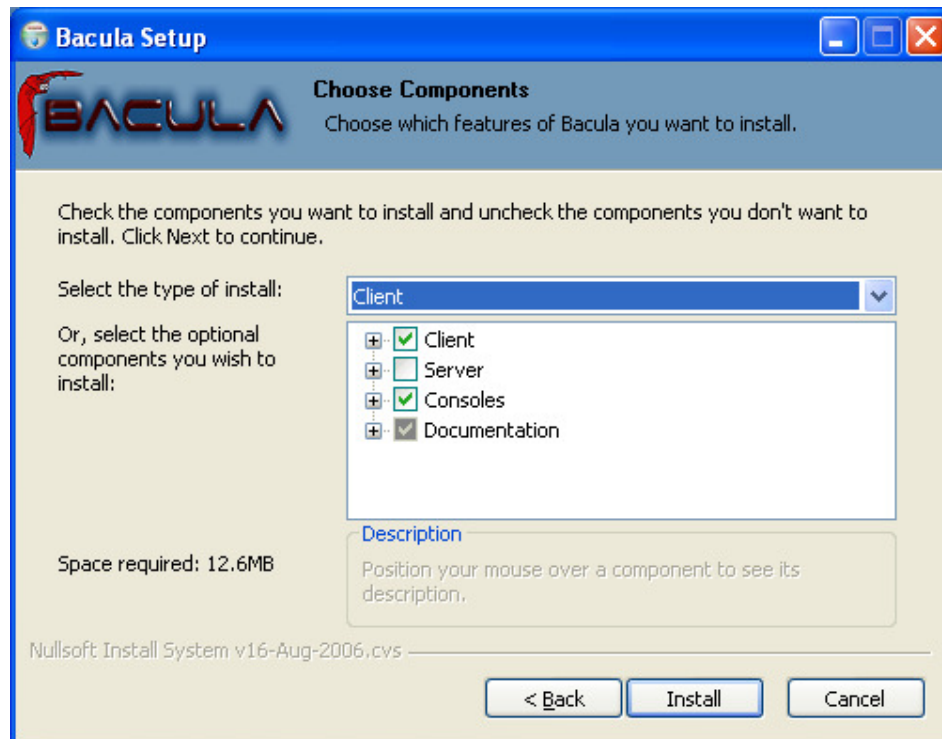

- If you are installing for the first time, you will be asked to enter some very basic information about your configuration. If you are not sure what to enter, or have previously saved configuration files, you can put anything you want into the fields, then either replace the configuration files later with the ones saved, or edit the file.

If you are upgrading an existing installation, the following will not be displayed.

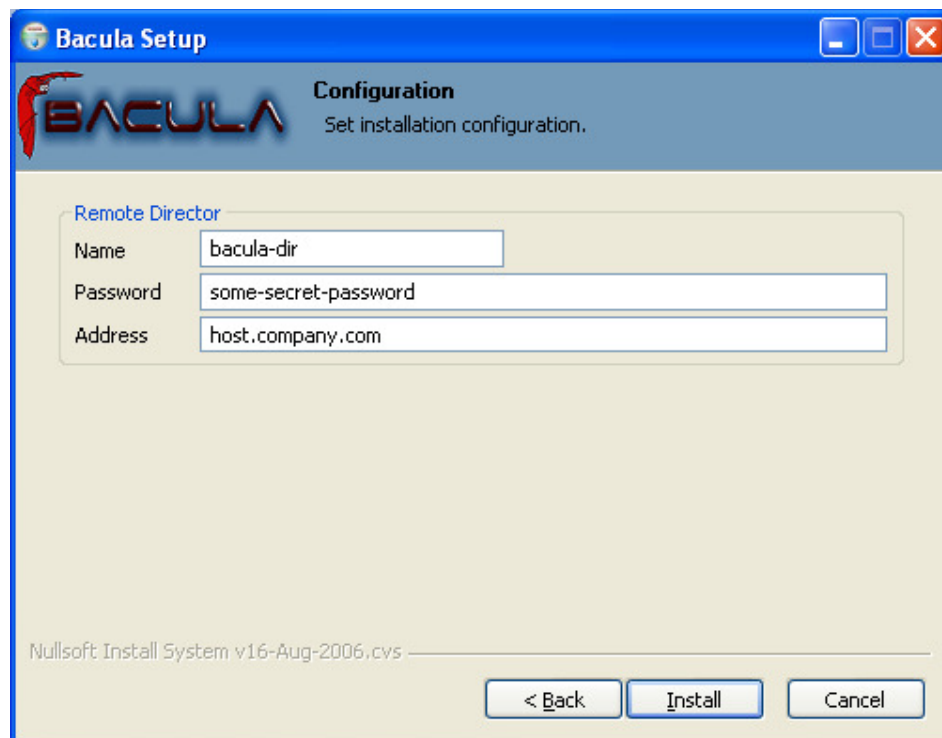

- While the various files are being loaded, you will see the following dialog:

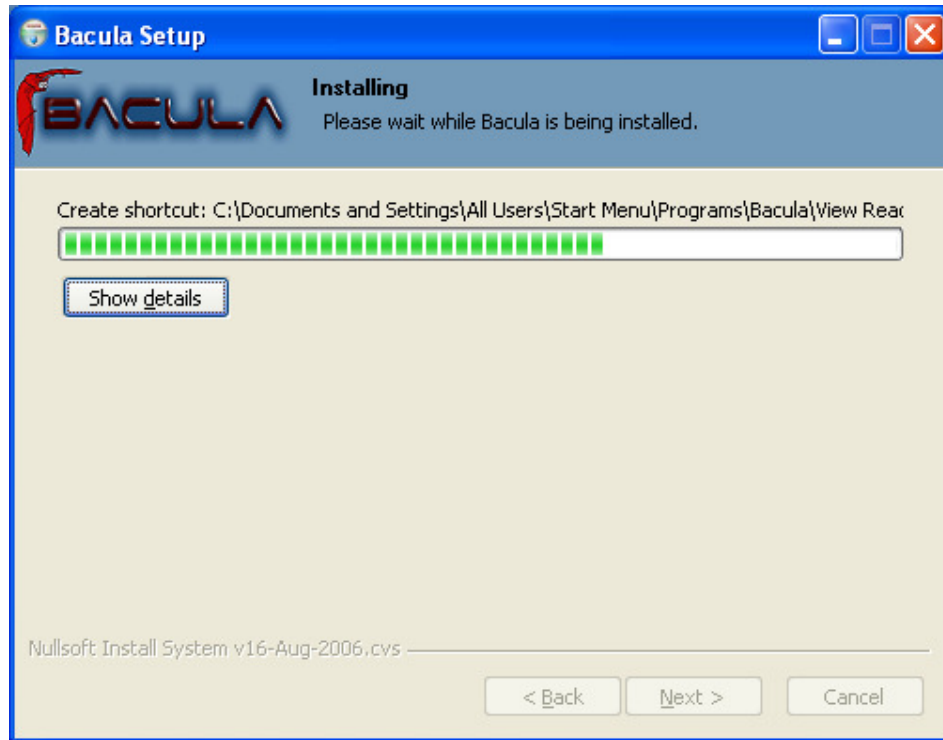

- Finally, the finish dialog will appear:

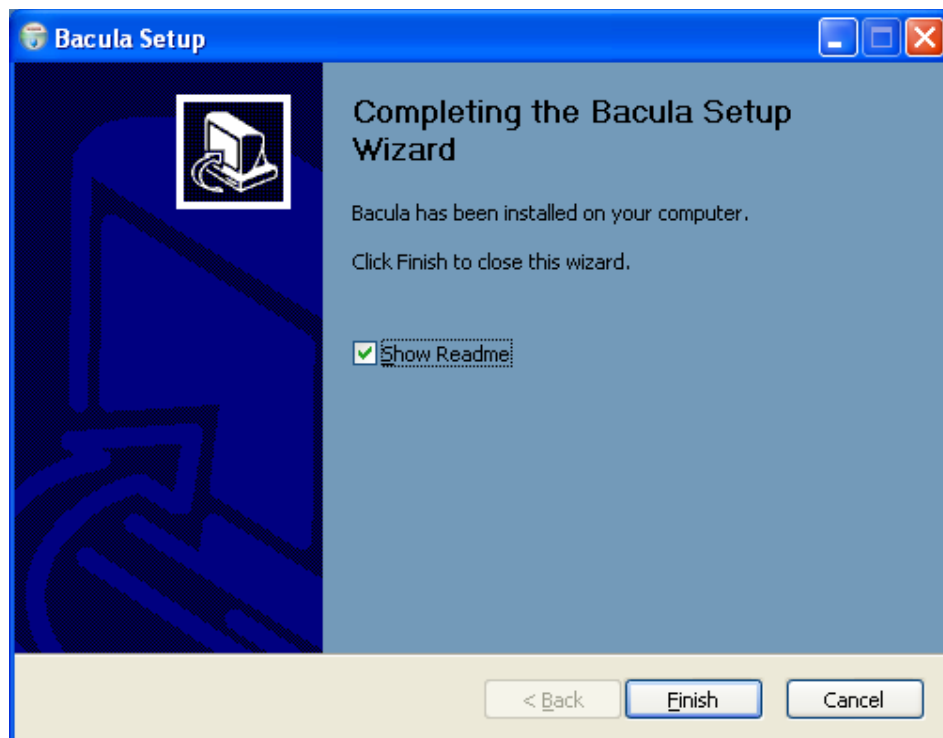

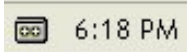

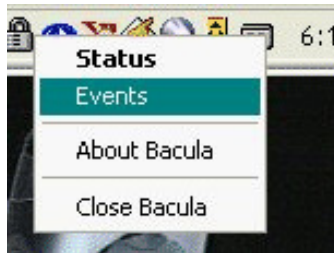
That should complete the installation process. When the Bacula File Server is ready to serve files, an icon  representing a cassette (or tape) will appear in the system tray ; right click on it and a menu will appear.



The **Events** item is currently unimplemented, by selecting the **Status** item, you can verify whether any jobs are running or not.

When the Bacula File Server begins saving files, the color of the holes in the cassette icon will change from

white to green , and if there is an error, the holes in the cassette icon will change to red .

If you are using remote desktop connections between your Windows boxes, be warned that that tray icon does not always appear. It will always be visible when you log into the console, but the remote desktop may not display it.

34.2 Post Windows Installation

After installing Bacula and before running it, you should check the contents of the configuration files to ensure that they correspond to your installation. You can get to them by using: the **Start>All Programs->Bacula** menu item.

Finally, but pulling up the Task Manager (ctl-alt-del), verify that Bacula is running as a process (not an Application) with User Name SYSTEM. If this is not the case, you probably have not installed Bacula while running as Administrator, and hence it will be unlikely that Bacula can access all the system files.

34.3 Uninstalling Bacula on Windows

Once Bacula has been installed, it can be uninstalled using the standard Windows Add/Remove Programs dialog found on the Control panel.

34.4 Dealing with Windows Problems

Sometimes Windows machines the File daemon may have very slow backup transfer rates compared to other machines. To you might try setting the Maximum Network Buffer Size to 32,768 in both the File daemon and in the Storage daemon. The default size is larger, and apparently some Windows ethernet controllers do not deal with a larger network buffer size.

Many Windows ethernet drivers have a tendency to either run slowly due to old broken firmware, or because they are running in half-duplex mode. Please check with the ethernet card manufacturer for the latest firmware and use whatever techniques are necessary to ensure that the card is running in duplex.

If you are not using the portable option, and you have VSS (Volume Shadow Copy) enabled in the Director, and you experience problems with Bacula not being able to open files, it is most likely that you are running an antivirus program that blocks Bacula from doing certain operations. In this case, disable the antivirus program and try another backup. If it succeeds, either get a different (better) antivirus program or use something like RunClientJobBefore/After to turn off the antivirus program while the backup is running.

If turning off anti-virus software does not resolve your VSS problems, you might have to turn on VSS debugging. The following link describes how to do this: <http://support.microsoft.com/kb/887013/en-us> .

In Microsoft Windows Small Business Server 2003 the VSS Writer for Exchange is turned off by default. To turn it on, please see the following link: <http://support.microsoft.com/default.aspx?scid=kb;EN-US;Q838183>

The most likely source of problems is authentication when the Director attempts to connect to the File daemon that you installed. This can occur if the names and the passwords defined in the File daemon's configuration file **bacula-fd.conf** file on the Windows machine do not match with the names and the passwords in the Director's configuration file **bacula-dir.conf** located on your Unix/Linux server.

More specifically, the password found in the **Client** resource in the Director's configuration file must be the same as the password in the **Director** resource of the File daemon's configuration file. In addition, the name of the **Director** resource in the File daemon's configuration file must be the same as the name in the **Director** resource of the Director's configuration file.



It is a bit hard to explain in words, but if you understand that a Director normally has multiple Clients and a Client (or File daemon) may permit access by multiple Directors, you can see that the names and the passwords on both sides must match for proper authentication.

One user had serious problems with the configuration file until he realized that the Unix end of line conventions were used and Bacula wanted them in Windows format. This has not been confirmed though, and Bacula version 2.0.0 and above should now accept all end of line conventions (Windows, Unix, Mac).

Running Unix like programs on Windows machines is a bit frustrating because the Windows command line shell (DOS Window) is rather primitive. As a consequence, it is not generally possible to see the debug information and certain error messages that Bacula prints. With a bit of work, however, it is possible. When everything else fails and you want to **see** what is going on, try the following:

```
Start a DOS shell Window.  
c:\Program Files\bacula\bacula-fd -t >out  
type out
```

The precise path to bacula-fd depends on where it is installed. The **-t** option will cause Bacula to read the configuration file, print any error messages and then exit. the **>** redirects the output to the file named **out**, which you can list with the **type** command.

If something is going wrong later, or you want to run **Bacula** with a debug option, you might try starting it as:

```
c:\Program Files\bacula\bin\bacula-fd -d 100 >out
```

In this case, Bacula will run until you explicitly stop it, which will give you a chance to connect to it from your Unix/Linux server. In later versions of Bacula (1.34 on, I think), when you start the File daemon in debug mode it can write the output to a trace file **bacula.trace** in the current directory. To enable this, before running a job, use the console, and enter:

```
trace on
```

then run the job, and once you have terminated the File daemon, you will find the debug output in the **bacula.trace** file, which will probably be located in the same directory as bacula-fd.exe.

In addition, you should look in the System Applications log on the Control Panel to find any Windows errors that Bacula got during the startup process.

Finally, due to the above problems, when you turn on debugging, and specify trace=1 on a setdebug command in the Console, Bacula will write the debug information to the file **bacula.trace** in the directory from which Bacula is executing.

If you are having problems with ClientRunBeforeJob scripts randomly dying, it is possible that you have run into an Oracle bug. See bug number 622 in the bugs.bacula.org database. The following information has been provided by a user on this issue:

The information in this document applies to:

Oracle HTTP Server - Version: 9.0.4

Microsoft Windows Server 2003

Symptoms

When starting an OC4J instance, the System Clock runs faster, about 7 seconds per minute.

Cause

+ This is caused by the Sun JVM bug 4500388, which states that "Calling Thread.sleep() with a small argument affects the system clock". Although this is reported as fixed in JDK 1.4.0_02, several reports contradict this (see the bug in http://bugs.sun.com/bugdatabase/view_bug.do?bug_id=4500388).

+ Also reported by Microsoft as "The system clock may run fast when you use the ACPI power management timer as a high-resolution counter on Windows 2000-based computers" (See <http://support.microsoft.com/?id=821893>)

You may wish to start the daemon with debug mode on rather than doing it using bconsole. To do so, edit the following registry key:

```
HKEY_LOCAL_MACHINE\HARDWARE\SYSTEM\CurrentControlSet\Services\Bacula-dir
```

using regedit, then add -dnn after the /service option, where nn represents the debug level you want.



34.5 Windows Compatibility Considerations

If you are not using the VSS (Volume Shadow Copy) option described in the next section of this chapter, and if any applications are running during the backup and they have files opened exclusively, Bacula will not be able to backup those files, so be sure you close your applications (or tell your users to close their applications) before the backup. Fortunately, most Microsoft applications do not open files exclusively so that they can be backed up. However, you will need to experiment. In any case, if Bacula cannot open the file, it will print an error message, so you will always know which files were not backed up. For version 1.37.25 and greater, see the section below on Volume Shadow Copy Service that permits backing up any file. During backup, Bacula doesn't know about the system registry, so you will either need to write it out to an ASCII file using `regedit /e` or use a program specifically designed to make a copy or backup the registry. In Bacula version 1.31 and later, we use Windows backup API calls by default. Typical of Windows, programming these special BackupRead and BackupWrite calls is a real nightmare of complications. The end result gives some distinct advantages and some disadvantages.

First, the advantages are that Windows systems, the security and ownership information is now backed up. In addition, with the exception of files in exclusive use by another program, Bacula can now access all system files. This means that when you restore files, the security and ownership information will be restored on Windows along with the data.

The disadvantage of the Windows backup API calls is that it produces non-portable backups. That is files and their data that are backed up on Windows using the native API calls (BackupRead/BackupWrite) cannot be directly restored on Linux or Unix systems. Bacula should be able to read non-portable backups on any system and restore the data appropriately. However, on a system that does not have the BackupRead/BackupWrite calls (older Windows versions and all Unix/Linux machines), though the file data can be restored, the Windows security and access control data will not be restored. This means that a standard set of access permissions will be set for such restored files.

As a default, Bacula backs up Windows systems using the Windows API calls. If you want to backup data on a Windows system and restore it on a Unix or Linux system, we have provided a special **portable** option that backs up the data in a portable fashion by using portable API calls. See the portable option on the Include statement in a FileSet resource in the Director's configuration chapter for the details on setting this option. However, using the portable option means you may have permissions problems accessing files, and none of the security and ownership information will be backed up or restored. The file data can, however, be restored on any system.

You should always be able to restore any file backed up on Unix or Win95/98/Me to any other system. On some older Windows systems, you may have to reset the ownership of such restored files.

Finally, if you specify the **portable=yes** option on the files you back up. Bacula will be able to restore them on any other system. However, any Windows specific security and ownership information will be lost. The following matrix will give you an idea of what you can expect. Thanks to Marc Brueckner for doing the tests:

Backup OS	Restore OS	Results
Win Me		
WinMe	WinMe	Works
WinMe	WinNT	Works (SYSTEM permissions)
WinMe	WinXP	Works (SYSTEM permissions)
WinMe	Linux	Works (SYSTEM permissions)
Win XP		
WinXP	WinXP	Works
WinXP	WinNT	Works (all files OK, but got "The data is invalid" message)
WinXP	WinMe	Error: Win32 data stream not supported.
WinXP	WinMe	Works if Portable=yes specified during backup.
WinXP	Linux	Error: Win32 data stream not supported.
WinXP	Linux	Works if Portable=yes specified during backup.

Cont. on next page



Backup OS	Restore OS	Results
<i>Win NT</i>		
WinNT	WinNT	Works
WinNT	WinXP	Works
WinNT	WinMe	Error: Win32 data stream not supported.
WinNT	WinMe	Works if Portable=yes specified during backup.
WinNT	Linux	Error: Win32 data stream not supported.
WinNT	Linux	Works if Portable=yes specified during backup.
<i>Linux</i>		
Linux	Linux	Works
Linux	WinNT	Works (SYSTEM permissions)
Linux	WinMe	Works
Linux	WinXP	Works (SYSTEM permissions)

Table 34.1: WinNT/2K/XP Restore Portability Status

Note: with Bacula versions 1.39.x and later, non-portable Windows data can be restore to any machine.

34.6 Volume Shadow Copy Service

Microsoft added VSS to Windows XP and Windows 2003. From the perspective of a backup-solution for Windows, this is an extremely important step. VSS allows Bacula to backup open files and even to interact with applications like RDBMS to produce consistent file copies. VSS aware applications are called VSS Writers, they register with the OS so that when Bacula wants to do a Snapshot, the OS will notify the register Writer programs, which may then create a consistent state in their application, which will be backed up. Examples for these writers are "MSDE" (Microsoft database engine), "Event Log Writer", "Registry Writer" plus 3rd party-writers. If you have a non-vss aware application (e.g. SQL Anywhere or probably MySQL), a shadow copy is still generated and the open files can be backed up, but there is no guarantee that the file is consistent.

Bacula produces a message from each of the registered writer programs when it is doing a VSS backup so you know which ones are correctly backed up.

Technically Bacula creates a shadow copy as soon as the backup process starts. It does then backup all files from the shadow copy and destroys the shadow copy after the backup process. Please have in mind, that VSS creates a snapshot and thus backs up the system at the state it had when starting the backup. It will disregard file changes which occur during the backup process.

VSS can be turned on by placing an

```
Enable VSS = yes
```

in your FileSet resource.

The VSS aware File daemon has the letters VSS on the signon line that it produces when contacted by the console. For example:

```
Tibs-fd Version: 1.37.32 (22 July 2005) VSS Windows XP MVS NT 5.1.2600
```

the VSS is shown in the line above. This only means that the File daemon is capable of doing VSS not that VSS is turned on for a particular backup. There are two ways of telling if VSS is actually turned on during a backup. The first is to look at the status output for a job, e.g.:

Running Jobs:

```
JobId 1 Job NightlySave.2005-07-23_13.25.45 is running.
  VSS Backup Job started: 23-Jul-05 13:25
  Files=70,113 Bytes=3,987,180,650 Bytes/sec=3,244,247
  Files Examined=75,021
  Processing file: c:/Documents and Settings/kern/My Documents/My Pictures/Misc1/Sans titre - 39.pdd
  SDRReadSeqNo=5 fd=352
```



Here, you see under Running Jobs that JobId 1 is "VSS Backup Job started ..." This means that VSS is enabled for that job. If VSS is not enabled, it will simply show "Backup Job started ..." without the letters VSS.

The second way to know that the job was backed up with VSS is to look at the Job Report, which will look something like the following:

```
23-Jul 13:25 rufus-dir: Start Backup JobId 1, Job=NightlySave.2005-07-23_13.25.45
23-Jul 13:26 rufus-sd: Wrote label to pre-labeled Volume "TestVolume001" on device "DDS-4" (/dev/nst0)
23-Jul 13:26 rufus-sd: Spooling data ...
23-Jul 13:26 Tibs: Generate VSS snapshots. Driver="VSS WinXP", Drive(s)="C"
23-Jul 13:26 Tibs: VSS Writer: "MSDEWriter", State: 1 (VSS_WS_STABLE)
23-Jul 13:26 Tibs: VSS Writer: "Microsoft Writer (Bootable State)", State: 1 (VSS_WS_STABLE)
23-Jul 13:26 Tibs: VSS Writer: "WMI Writer", State: 1 (VSS_WS_STABLE)
23-Jul 13:26 Tibs: VSS Writer: "Microsoft Writer (Service State)", State: 1 (VSS_WS_STABLE)
```

In the above Job Report listing, you see that the VSS snapshot was generated for drive C (if other drives are backed up, they will be listed on the **Drive(s)="C"**). You also see the reports from each of the writer program. Here they all report VSS_WS_STABLE, which means that you will get a consistent snapshot of the data handled by that writer.

34.7 VSS Problems

Problems!VSS

If you are experiencing problems such as VSS hanging on MSDE, first try running **vssadmin** to check for problems, then try running **ntbackup** which also uses VSS to see if it has similar problems. If so, you know that the problem is in your Windows machine and not with Bacula.

The FD hang problems were reported with **MSDEwriter** when:

- a local firewall locked local access to the MSDE TCP port (MSDEwriter seems to use TCP/IP and not Named Pipes).
- msdtcs was installed to run under "localsystem": try running msdtcs under networking account (instead of local system) (com+ seems to work better with this configuration).

34.8 Windows Firewalls

If you turn on the firewalling feature on Windows (default in WinXP SP2), you are likely to find that the Bacula ports are blocked and you cannot communicate to the other daemons. This can be deactivated through the **Security Notification** dialog, which is apparently somewhere in the **Security Center**. I don't have this on my computer, so I cannot give the exact details.

The command:

```
netsh firewall set opmode disable
```

is purported to disable the firewall, but this command is not accepted on my WinXP Home machine.

34.9 Windows Port Usage

If you want to see if the File daemon has properly opened the port and is listening, you can enter the following command in a shell window:

```
netstat -an | findstr 910[123]
```

TopView is another program that has been recommended, but it is not a standard Windows program, so you must find and download it from the Internet.

34.10 Windows Disaster Recovery

We don't currently have a good solution for disaster recovery on Windows as we do on Linux. The main piece lacking is a Windows boot floppy or a Windows boot CD. Microsoft releases a Windows Pre-installation Environment (**WinPE**) that could possibly work, but we have not investigated it. This means that until someone figures out the correct procedure, you must restore the OS from the installation disks, then you can load a Bacula client and restore files. Please don't count on using **bextract** to extract files from your



backup tapes during a disaster recovery unless you have backed up those files using the **portable** option. **bextract** does not run on Windows, and the normal way Bacula saves files using the Windows API prevents the files from being restored on a Unix machine. Once you have an operational Windows OS loaded, you can run the File daemon and restore your user files.

Please see Disaster Recovery of Windows Systems for the latest suggestion, which looks very promising.

It looks like Bart PE Builder, which creates a Windows PE (Pre-installation Environment) Boot-CD, may be just what is needed to build a complete disaster recovery system for Windows. This distribution can be found at <http://www.nu2.nu/pebuilder/>.

34.11 Windows Restore Problems

Please see the Restore Chapter of this manual for problems that you might encounter doing a restore.

sectionWindows Backup Problems If during a Backup, you get the message: **ERR=Access is denied** and you are using the portable option, you should try both adding both the non-portable (backup API) and the Volume Shadow Copy options to your Director's conf file.

In the Options resource:

```
portable = no
```

In the FileSet resource:

```
enablevss = yes
```

In general, specifying these two options should allow you to backup any file on a Windows system. However, in some cases, if users have allowed to have full control of their folders, even system programs such a Bacula can be locked out. In this case, you must identify which folders or files are creating the problem and do the following:

1. Grant ownership of the file/folder to the Administrators group, with the option to replace the owner on all child objects.
2. Grant full control permissions to the Administrators group, and change the user's group to only have Modify permission to the file/folder and all child objects.

Thanks to Georger Araujo for the above information.

34.12 Windows Ownership and Permissions Problems

If you restore files backed up from Windows to an alternate directory, Bacula may need to create some higher level directories that were not saved (or restored). In this case, the File daemon will create them under the SYSTEM account because that is the account that Bacula runs under as a service. As of version 1.32f-3, Bacula creates these files with full access permission. However, there may be cases where you have problems accessing those files even if you run as administrator. In principle, Microsoft supplies you with the way to cease the ownership of those files and thus change the permissions. However, a much better solution to working with and changing Windows permissions is the program **SetACL**, which can be found at <http://setacl.sourceforge.net/>.

If you have not installed Bacula while running as Administrator and if Bacula is not running as a Process with the userid (User Name) SYSTEM, then it is very unlikely that it will have sufficient permission to access all your files.

Some users have experienced problems restoring files that participate in the Active Directory. They also report that changing the userid under which Bacula (bacula-fd.exe) runs, from SYSTEM to a Domain Admin userid, resolves the problem.

34.13 Manually resetting the Permissions

The following solution was provided by Dan Langille <dan at langille in the dot org domain>. The steps are performed using Windows 2000 Server but they should apply to most Windows platforms. The procedure outlines how to deal with a problem which arises when a restore creates a top-level new directory. In this example, "top-level" means something like **c:\src**, not **c:\tmp\src** where **c:\tmp** already exists. If a restore job specifies / as the **Where:** value, this problem will arise.

The problem appears as a directory which cannot be browsed with Windows Explorer. The symptoms include the following message when you try to click on that directory:



If you encounter this message, the following steps will change the permissions to allow full access.

1. right click on the top level directory (in this example, **c:/src**) and select **Properties**.
2. click on the Security tab.
3. If the following message appears, you can ignore it, and click on **OK**.

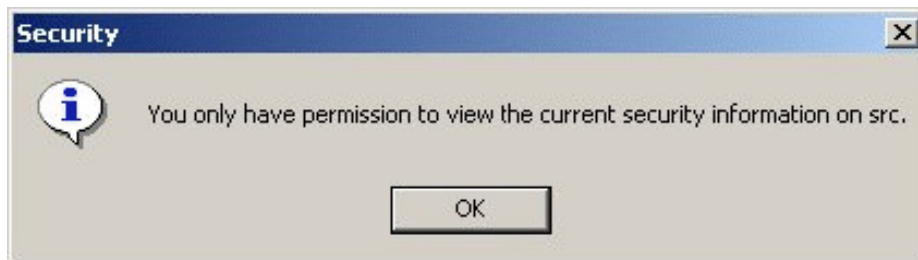

You should see something like this:

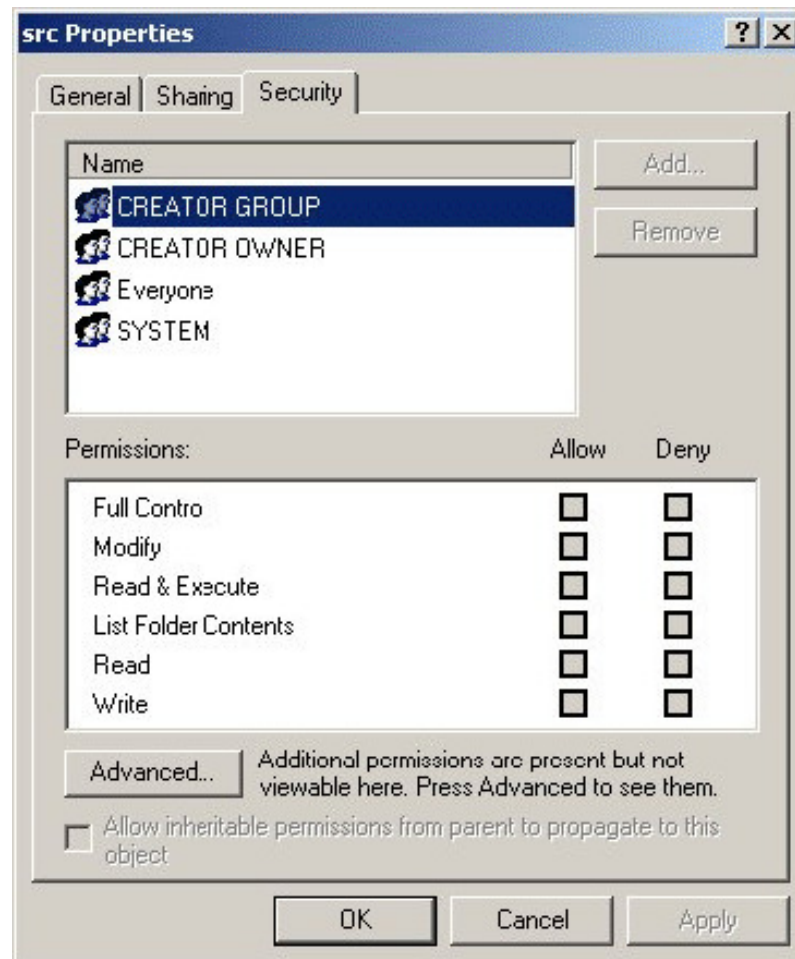

4. click on Advanced



- click on the Owner tab
- Change the owner to something other than the current owner (which is **SYSTEM** in this example as shown below).

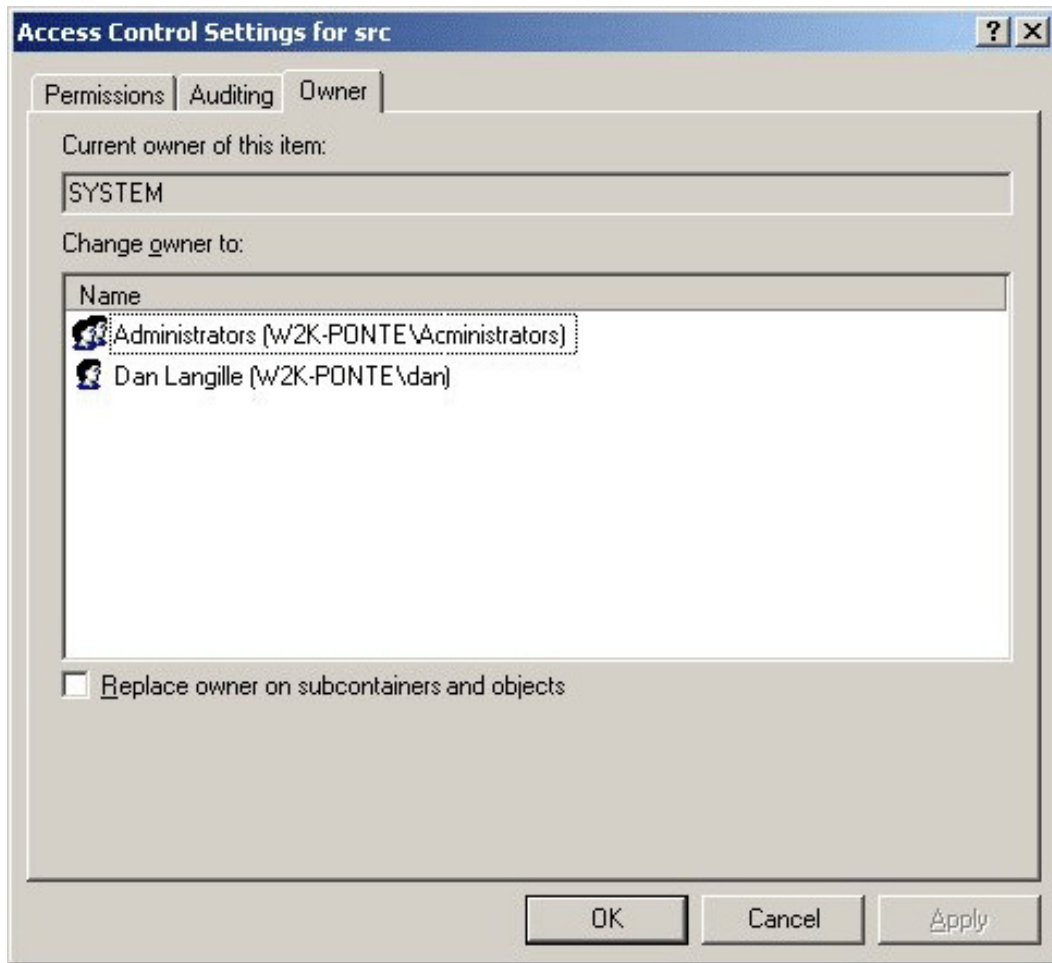

- ensure the "Replace owner on subcontainers and objects" box is checked
- click on OK
- When the message "You do not have permission to read the contents of directory c:\src\basis. Do you wish to replace the directory permissions with permissions granting you Full Control?", click on Yes.

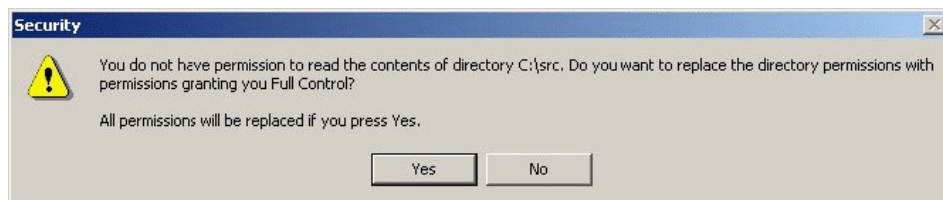

- Click on OK to close the Properties tab

With the above procedure, you should now have full control over your restored directory.

In addition to the above methods of changing permissions, there is a Microsoft program named **cacls** that can perform similar functions.

34.14 Backing Up the WinNT/XP/2K System State

Note, most of this section applies to the older Windows OSes that do not have VSS. On newer Windows OSes that have VSS, all files including the System State will by default be properly backed up by Bacula.



A suggestion by Damian Coutts using Microsoft's NTBackup utility in conjunction with Bacula should permit a full restore of any damaged system files on Win2K/XP. His suggestion is to do an NTBackup of the critical system state prior to running a Bacula backup with the following command:

```
ntbackup backup systemstate /F c:\systemstate.bkf
```

The **backup** is the command, the **systemstate** says to backup only the system state and not all the user files, and the **/F c:\systemstate.bkf** specifies where to write the state file. This file must then be saved and restored by Bacula.

To restore the system state, you first reload a base operating system if the OS is damaged, otherwise, this is not necessary, then you would use Bacula to restore all the damaged or lost user's files and to recover the **c:\systemstate.bkf** file. Finally if there are any damaged or missing system files or registry problems, you run **NTBackup** and **catalogue** the system statefile, and then select it for restore. The documentation says you can't run a command line restore of the systemstate.

To the best of my knowledge, this has not yet been tested. If you test it, please report your results to the Bacula email list.

Note, Bacula uses VSS to backup and restore open files and system files, but on older Windows machines such as WinNT and Win2000, VSS is not implemented by Microsoft so that you must use some special techniques to back them up as described above. On new Windows machines, Bacula will backup and restore all files including the system state providing you have VSS enabled in your Bacula FileSet (default).

34.15 Fixing the Windows Boot Record

A tip from a user: An effective way to restore a Windows backup for those who do not purchase the bare metal restore capability is to install Windows on a different hard drive and restore the backup. Then run the recovery CD and run

```
diskpart
  select disk 0
  select part 1
  active
  exit

bootrec /rebulbcd
bootrec /fixboot
bootrec /fixmbr
```

34.16 Considerations for Filename Specifications

Please see the Director's Configuration chapter of this manual for important considerations on how to specify Windows paths in Bacula FileSet Include and Exclude directives.

Bacula versions prior to 1.37.28 do not support Windows Unicode filenames. As of that version, both **bconsole** and **bwconsole** support Windows Unicode filenames. There may still be some problems with multiple byte characters (e.g. Chinese, ...) where it is a two byte character but the displayed character is not two characters wide.

Path/filenames longer than 260 characters (up to 32,000) are supported beginning with Bacula version 1.39.20. Older Bacula versions support only 260 character path/filenames.

34.17 Windows Specific File daemon Command Line

These options are not normally seen or used by the user, and are documented here only for information purposes. At the current time, to change the default options, you must either manually run **Bacula** or you must manually edit the system registry and modify the appropriate entries.

In order to avoid option clashes between the options necessary for **Bacula** to run on Windows and the standard Bacula options, all Windows specific options are signaled with a forward slash character (/), while as usual, the standard Bacula options are signaled with a minus (-), or a minus minus (--). All the standard Bacula options can be used on the Windows version. In addition, the following Windows only options are implemented:

/service Start Bacula as a service



- /run** Run the Bacula application
- /install** Install Bacula as a service in the system registry
- /remove** Uninstall Bacula from the system registry
- /about** Show the Bacula about dialogue box
- /status** Show the Bacula status dialogue box
- /events** Show the Bacula events dialogue box (not yet implemented)
- /kill** Stop any running **Bacula**
- /help** Show the Bacula help dialogue box

It is important to note that under normal circumstances the user should never need to use these options as they are normally handled by the system automatically once Bacula is installed. However, you may note these options in some of the .bat files that have been created for your use.

34.18 Shutting down Windows Systems

Some users like to shutdown their Windows machines after a backup using a Client Run After Job directive. If you want to do something similar, you might take the shutdown program from the apcupsd project or one from the Sysinternals project .



Chapter 35

Disaster Recovery Using Bacula

35.1 General

When disaster strikes, you must have a plan, and you must have prepared in advance otherwise the work of recovering your system and your files will be considerably greater. For example, if you have not previously saved the partitioning information for your hard disk, how can you properly rebuild it if the disk must be replaced?

Unfortunately, many of the steps one must take before and immediately after a disaster are very operating system dependent. As a consequence, this chapter will discuss in detail disaster recovery (also called Bare Metal Recovery) for **Linux** and **Solaris**. For Solaris, the procedures are still quite manual. For FreeBSD the same procedures may be used but they are not yet developed. For Win32, a number of Bacula users have reported success using BartPE.

35.2 Important Considerations

Here are a few important considerations concerning disaster recovery that you should take into account before a disaster strikes.

- If the building which houses your computers burns down or is otherwise destroyed, do you have off-site backup data?
- Disaster recovery is much easier if you have several machines. If you have a single machine, how will you handle unforeseen events if your only machine is down?
- Do you want to protect your whole system and use Bacula to recover everything? or do you want to try to restore your system from the original installation disks and apply any other updates and only restore user files?

35.3 Steps to Take Before Disaster Strikes

- Create a rescue or CDROM for each of your Linux systems. Generally, they are offered by each distribution, and there are many good rescue disks on the Web (Knoppix, sysrescuecd, PLD Linux rescue CD, tomsrtbt, RIP ...)
- Create a bacula-hostname directory on each machine and save it somewhere – possibly on a USB key.
- Ensure that you always have a valid bootstrap file for your backup and that it is saved to an alternate machine. This will permit you to easily do a full restore of your system.
- If possible copy your catalog nightly to an alternate machine. If you have a valid bootstrap file, this is not necessary, but can be very useful if you do not want to reload everything. .
- Ensure that you always have a valid bootstrap file for your catalog backup that is saved to an alternate machine. This will permit you to restore your catalog more easily if needed.
- Test using the Rescue CDROM before you are forced to use it in an emergency situation.



- Make a copy of your Bacula .conf files, particularly your bacula-dir.conf, and your bacula-sd.conf files, because if your server goes down, these files will be needed to get it back up and running, and they can be difficult to rebuild from memory.

35.4 Bare Metal Recovery on Linux with a Rescue CD

As an alternative to creating a Rescue CD, please see the section below entitled Bare Metal Recovery using a LiveCD.

Bacula previously had a Rescue CD. Unfortunately, this CD did not work on every Linux Distro, and in addition, Linux is evolving with different boot methods, more and more complex hardware configurations (LVM, RAID, WiFi, USB, ...). As a consequence, the Bacula Rescue CD as it was originally envisioned no longer exists.

However there are many other good rescue disks available. A so called "Bare Metal" recovery is one where you start with an empty hard disk and you restore your machine. There are also cases where you may lose a file or a directory and want it restored. Please see the previous chapter for more details for those cases.

Bare Metal Recovery assumes that you have the following items for your system:

- A Rescue CDROM containing a copy of your OS.
- Perhaps a copy of your hard disk information, as well as a statically linked version of the Bacula File daemon.
- A full Bacula backup of your system possibly including Incremental or Differential backups since the last Full backup
- A second system running the Bacula Director, the Catalog, and the Storage daemon. (this is not an absolute requirement, but how to get around it is not yet documented here)

35.5 Requirements

35.6 Restoring a Client System

Now, let's assume that your hard disk has just died and that you have replaced it with an new identical drive. In addition, we assume that you have:

1. A recent Bacula backup (Full plus Incrementals)
2. A Rescue CDROM.
3. Your Bacula Director, Catalog, and Storage daemon running on another machine on your local network.

This is a relatively simple case, and later in this chapter, as time permits, we will discuss how you might recover from a situation where the machine that crashes is your main Bacula server (i.e. has the Director, the Catalog, and the Storage daemon).

You will take the following steps to get your system back up and running:

1. Boot with your Rescue CDROM.
2. Start the Network (local network)
3. Re-partition your hard disk(s) as it was before
4. Re-format your partitions
5. Restore the Bacula File daemon (static version)
6. Perform a Bacula restore of all your files
7. Re-install your boot loader
8. Reboot

Now for the details ...



35.7 Boot with your Rescue CDROM

Each rescue disk boots somewhat differently. Please see the instructions that go with your CDROM.

Start the Network: You can test it by pinging another machine, or pinging your broken machine machine from another machine. Do not proceed until your network is up.

Partition Your Hard Disk(s):

Format Your Hard Disk(s):

Mount the Newly Formatted Disks:

Somehow get the static File daemon loaded on your system Put the static file daemon and its conf file in /tmp.

Restore and Start the File Daemon:

```
chroot /mnt/disk /tmp/bacula-fd -c /tmp/bacula-fd.conf
```

The above command starts the Bacula File daemon with the proper root disk location (i.e. **/mnt/disk/tmp**). If Bacula does not start, correct the problem and start it. You can check if it is running by entering:

```
ps fax
```

You can kill Bacula by entering:

```
kill -TERM <pid>
```

where **pid** is the first number printed in front of the first occurrence of **bacula-fd** in the **ps fax** command. Now, you should be able to use another computer with Bacula installed to check the status by entering:

```
status client=xxxx
```

into the Console program, where **xxxx** is the name of the client you are restoring.

One common problem is that your **bacula-dir.conf** may contain machine addresses that are not properly resolved on the stripped down system to be restored because it is not running DNS. This is particularly true for the address in the Storage resource of the Director, which may be very well resolved on the Director's machine, but not on the machine being restored and running the File daemon. In that case, be prepared to edit **bacula-dir.conf** to replace the name of the Storage daemon's domain name with its IP address.

Restore Your Files: On the computer that is running the Director, you now run a **restore** command and select the files to be restored (normally everything), but before starting the restore, there is one final change you must make using the **mod** option. You must change the **Where** directory to be the root by using the **mod** option just before running the job and selecting **Where**. Set it to:

```
/
```

then run the restore.

You might be tempted to avoid using **chroot** and running Bacula directly and then using a **Where** to specify a destination of **/mnt/disk**. This is possible, however, the current version of Bacula always restores files to the new location, and thus any soft links that have been specified with absolute paths will end up with **/mnt/disk** prefixed to them. In general this is not fatal to getting your system running, but be aware that you will have to fix these links if you do not use **chroot**.



Final Step:

```
/sbin/grub-install --root-directory=/mnt/disk /dev/hda
```

Note, in this case, you omit the `chroot` command, and you must replace `/dev/hda` with your boot device. If you don't know what your boot device is, run the `./run_grub` script once and it will tell you.

Finally, I've even run into a case where `grub-install` was unable to rewrite the boot block. In my case, it produced the following error message:

```
/dev/hdx does not have any corresponding BIOS drive.
```

The solution is to insure that all your disks are properly mounted on `/mnt/disk`, then do the following:

```
chroot /mnt/disk
mount /dev/pts
```

Then edit the file `/boot/grub/grub.conf` and uncomment the line that reads:

```
#boot=/dev/hda
```

So that it reads:

```
boot=/dev/hda
```

Note, the `/dev/hda` may be `/dev/sda` or possibly some other drive depending on your configuration, but in any case, it is the same as the one that you previously tried with **grub-install**.

Then, enter the following commands:

```
grub --batch --device-map=/boot/grub/device.map \
  --config-file=/boot/grub/grub.conf --no-floppy
root (hd0,0)
setup (hd0)
quit
```

If the **grub** call worked, you will get a prompt of **grub>** before the **root**, **setup**, and **quit** commands, and after entering the **setup** command, it should indicate that it successfully wrote the MBR (master boot record).

Reboot: First unmount all your hard disks, otherwise they will not be cleanly shutdown, then reboot your machine by entering **exit** until you get to the main prompt then enter **Ctrl-d**. Once back to the main CDROM prompt, you will need to turn the power off, then back on to your machine to get it to reboot.

If everything went well, you should now be back up and running. If not, re-insert the emergency boot CDROM, boot, and figure out what is wrong.

35.8 Restoring a Server

Above, we considered how to recover a client machine where a valid Bacula server was running on another machine. However, what happens if your server goes down and you no longer have a running Director, Catalog, or Storage daemon? There are several solutions:

1. Bring up static versions of your Director, Catalog, and Storage daemon on the damaged machine.
2. Move your server to another machine.
3. Use a Hot Spare Server on another Machine.

The first option, is very difficult because it requires you to have created a static version of the Director and the Storage daemon as well as the Catalog. If the Catalog uses MySQL or PostgreSQL, this may or may not be possible. In addition, to loading all these programs on a bare system (quite possible), you will need to make sure you have a valid driver for your tape drive.

The second suggestion is probably a much simpler solution, and one I have done myself. To do so, you might want to consider the following steps:

- If you are using MySQL or PostgreSQL, configure, build and install it from source (or use rpms) on your new system.



- Load the Bacula source code onto your new system, configure, install it, and create the Bacula database.
- Ideally, you will have a copy of all the Bacula conf files that were being used on your server. If not, you will at a minimum need create a `bacula-dir.conf` that has the same Client resource that was used to backup your system.
- If you have a valid saved Bootstrap file as created for your damaged machine with WriteBootstrap, use it to restore the files to the damaged machine, where you have loaded a static Bacula File daemon using the Rescue disk). This is done by using the `restore` command and at the `yes/mod/no` prompt, selecting **mod** then specifying the path to the bootstrap file.
- If you have the Bootstrap file, you should now be back up and running, if you do not have a Bootstrap file, continue with the suggestions below.
- Using **bscan** scan the last set of backup tapes into your MySQL, PostgreSQL or SQLite database.
- Start Bacula, and using the Console **restore** command, restore the last valid copy of the Bacula database and the Bacula configuration files.
- Move the database to the correct location.
- Start the database, and restart Bacula. Then use the Console **restore** command, restore all the files on the damaged machine, where you have loaded a Bacula File daemon using the Rescue disk.

For additional details of restoring your database, please see the Restoring When Things Go Wrong section of the Console Restore Command chapter of this manual.

35.9 Linux Problems or Bugs

Since every flavor and every release of Linux is different, there are likely to be some small difficulties with the scripts, so please be prepared to edit them in a minimal environment. A rudimentary knowledge of **vi** is very useful. Also, these scripts do not do everything. You will need to reformat Windows partitions by hand, for example.

Getting the boot loader back can be a problem if you are using **grub** because it is so complicated. If all else fails, reboot your system from your floppy but using the restored disk image, then proceed to a reinstallation of grub (looking at the `run-grub` script can help). By contrast, lilo is a piece of cake.

35.10 Bare Metal Recovery using a LiveCD

As an alternative to the old now defunct Bacula Rescue CDROM, you can use any system rescue or LiveCD to recover your system. The big problem with most rescue or LiveCDs is that they are not designed to capture the current state of your system, so when you boot them on a damaged system, you might be somewhat lost – e.g. how many of you remember your exact hard disk partitioning.

This lack can be easily corrected by running the part of the Bacula Rescue code that creates a directory containing a `static-bacula-fd`, a snapshot of your current system disk configuration, and scripts that help restoring it.

Before a disaster strikes:

1. Run only the **make bacula** part of the Bacula Rescue procedure to create the static Bacula File daemon, and system disk snapshot.
2. Save the directory generated (more details below) preferably on a CDROM or alternatively to some other system.
3. Possibly run **make bacula** every night as part of your backup process to ensure that you have a current snapshot of your system.

Then when disaster strikes, do the following:

1. Boot with your system rescue disk or LiveCD (e.g. Knoppix).
2. Start the Network (local network).



3. Copy the Bacula recovery directory to the damaged system using ftp, scp, wget or if your boot disk permits it reading it directly from a CDROM.
4. Continue as documented above.
5. Re-partition your hard disk(s) as it was before, if necessary.
6. Re-format your partitions, if necessary.
7. Restore the Bacula File daemon (static version).
8. Perform a Bacula restore of all your files.
9. Re-install your boot loader.
10. Reboot.

In order to create the Bacula recovery directory, you need a copy of the Bacula Rescue code as described above, and you must first configure that directory.

Once the configuration is done, you can do the following to create the Bacula recovery directory:

```
cd <bacula-rescue-source>/linux/cdrom
su (become root)
make bacula
```

The directory you want to save will be created in the current directory with the name **bacula**. You need only save that directory either as a directory or possibly as a compressed tar file. If you run this procedure on multiple machines, you will probably want to rename this directory to something like **bacula-hostname**.

35.11 FreeBSD Bare Metal Recovery

The same basic techniques described above also apply to FreeBSD. Although we don't yet have a fully automated procedure, Alex Torres Molina has provided us with the following instructions with a few additions from Jesse Guardiani and Dan Langille:

1. Boot with the FreeBSD installation disk
2. Go to Custom, Partition and create your slices and go to Label and create the partitions that you want. Apply changes.
3. Go to Fixit to start an emergency console.
4. Create devs ad0 if they don't exist under /mnt2/dev (in my situation) with MAKEDEV. The device or devices you create depend on what hard drives you have. ad0 is your first ATA drive. da0 would be your first SCSI drive. Under OS version 5 and greater, your device files are most likely automatically created for you.
5. mkdir /mnt/disk this is the root of the new disk
6. mount /mnt2/dev/ad0s1a /mnt/disk mount /mnt2/dev/ad0s1c /mnt/disk/var mount /mnt2/dev/ad0s1d /mnt/disk/usr The same hard drive issues as above apply here too. Note, under OS version 5 or higher, your disk devices may be in /dev not /mnt2/dev.
7. Network configuration (ifconfig xl0 ip/mask + route add default ip-gateway)
8. mkdir /mnt/disk/tmp
9. cd /mnt/disk/tmp
10. Copy bacula-fd and bacula-fd.conf to this path
11. If you need to, use sftp to copy files, after which you must do this: ln -s /mnt2/usr/bin /usr/bin
12. chmod u+x bacula-fd
13. Modify bacula-fd.conf to fit this machine
14. Copy /bin/sh to /mnt/disk, necessary for chroot



15. Don't forget to put your bacula-dir's IP address and domain name in `/mnt/disk/etc/hosts` if it's not on a public net. Otherwise the FD on the machine you are restoring to won't be able to contact the SD and DIR on the remote machine.
16. `mkdir -p /mnt/disk/var/db/bacula`
17. `chroot /mnt/disk /tmp/bacula-fd -c /tmp/bacula-fd.conf` to start bacula-fd
18. Now you can go to bacula-dir and restore the job with the entire contents of the broken server.
19. You must create `/proc`

35.12 Solaris Bare Metal Recovery

The same basic techniques described above apply to Solaris:

- the same restrictions as those given for Linux apply
- you will need to create a Rescue disk

However, during the recovery phase, the boot and disk preparation procedures are different:

- there is no need to create an emergency boot disk since it is an integrated part of the Solaris boot.
- you must partition and format your hard disk by hand following manual procedures as described in W. Curtis Preston's book "Unix Backup & Recovery"

Once the disk is partitioned, formatted and mounted, you can continue with bringing up the network and reloading Bacula.

35.13 Preparing Solaris Before a Disaster

As mentioned above, before a disaster strikes, you should prepare the information needed in the case of problems. To do so, in the `rescue/solaris` subdirectory enter:

```
su
./getdiskinfo
./make_rescue_disk
```

The `getdiskinfo` script will, as in the case of Linux described above, create a subdirectory `diskinfo` containing the output from several system utilities. In addition, it will contain the output from the `SysAudit` program as described in Curtis Preston's book. This file `diskinfo/sysaudit.bsi` will contain the disk partitioning information that will allow you to manually follow the procedures in the "Unix Backup & Recovery" book to repartition and format your hard disk. In addition, the `getdiskinfo` script will create a `start_network` script.

Once you have your disks repartitioned and formatted, do the following:

- Start Your Network with the `start_network` script
- Restore the Bacula File daemon as documented above
- Perform a Bacula restore of all your files using the same commands as described above for Linux
- Re-install your boot loader using the instructions outlined in the "Unix Backup & Recovery" book using `installboot`

35.14 Bugs and Other Considerations

Directory Modification and Access Times are Modified on pre-1.30 Baculas : When a pre-1.30 version of Bacula restores a directory, it first must create the directory, then it populates the directory with its files and subdirectories. The act of creating the files and subdirectories updates both the modification and access times associated with the directory itself. As a consequence, all modification and access times of all directories will be updated to the time of the restore.

This has been corrected in Bacula version 1.30 and later. The directory modification and access times are reset to the value saved in the backup after all the files and subdirectories have been restored. This has been tested and verified on normal restore operations, but not verified during a bare metal recovery.



Strange Bootstrap Files: If any of you look closely at the bootstrap file that is produced and used for the restore (I sure do), you will probably notice that the FileIndex item does not include all the files saved to the tape. This is because in some instances there are duplicates (especially in the case of an Incremental save), and in such circumstances, **Bacula** restores only the last of multiple copies of a file or directory.

35.15 Disaster Recovery of Win32 Systems

Due to open system files, and registry problems, Bacula cannot save and restore a complete Win2K/XP/NT environment.

A suggestion by Damian Coutts using Microsoft's NTBackup utility in conjunction with Bacula should permit a Full bare metal restore of Win2K/XP (and possibly NT systems). His suggestion is to do an NTBackup of the critical system state prior to running a Bacula backup with the following command:

```
ntbackup backup systemstate /F c:\systemstate.bkf
```

The **backup** is the command, the **systemstate** says to backup only the system state and not all the user files, and the **/F c:\systemstate.bkf** specifies where to write the state file. this file must then be saved and restored by Bacula. This command can be put in a Client Run Before Job directive so that it is automatically run during each backup, and thus saved to a Bacula Volume.

To restore the system state, you first reload a base operating system, then you would use Bacula to restore all the users files and to recover the **c:\systemstate.bkf** file, and finally, run **NTBackup** and **catalogue** the system statefile, and then select it for restore. The documentation says you can't run a command line restore of the systemstate.

This procedure has been confirmed to work by Ludovic Strappazon – many thanks!

A new tool is provided in the form of a bacula plugin for the BartPE rescue CD. BartPE is a self-contained WindowsXP boot CD which you can make using the PeBuilder tools available at <http://www.nu2.nu/pebuilder/> and a valid Windows XP SP1 CDROM. The plugin is provided as a zip archive. Unzip the file and copy the bacula directory into the plugin directory of your BartPE installation. Edit the configuration files to suit your installation and build your CD according to the instructions at Bart's site. This will permit you to boot from the cd, configure and start networking, start the bacula file client and access your director with the console program. The programs menu on the booted CD contains entries to install the file client service, start the file client service, and start the WX-Console. You can also open a command line window and CD Programs\Bacula and run the command line console bconsole.

35.16 Ownership and Permissions on Win32 Systems

Bacula versions after 1.31 should properly restore ownership and permissions on all WinNT/XP/2K systems. If you do experience problems, generally in restores to alternate directories because higher level directories were not backed up by Bacula, you can correct any problems with the **SetACL** available under the GPL license at: <http://sourceforge.net/projects/setacl/> .

35.17 Alternate Disaster Recovery Suggestion for Win32 Systems

Ludovic Strappazon has suggested an interesting way to backup and restore complete Win32 partitions. Simply boot your Win32 system with a Linux Rescue disk as described above for Linux, install a statically linked Bacula, and backup any of the raw partitions you want. Then to restore the system, you simply restore the raw partition or partitions. Here is the email that Ludovic recently sent on that subject:

```
I've just finished testing my brand new cd LFS/Bacula
with a raw Bacula backup and restore of my portable.
I can't resist sending you the results: look at the rates !!!
hunt-dir: Start Backup JobId 100, Job=HuntBackup.2003-04-17_12.58.26
hunt-dir: Bacula 1.30 (14Apr03): 17-Apr-2003 13:14
JobId:                100
Job:                  HuntBackup.2003-04-17_12.58.26
FileSet:              RawPartition
Backup Level:         Full
Client:               sauvegarde-fd
Start time:           17-Apr-2003 12:58
End time:             17-Apr-2003 13:14
Files Written:        1
Bytes Written:        10,058,586,272
```

```
Rate: 10734.9 KB/s
Software Compression: None
Volume names(s): 000103
Volume Session Id: 2
Volume Session Time: 1050576790
Last Volume Bytes: 10,080,883,520
FD termination status: OK
SD termination status: OK
Termination: Backup OK
hunt-dir: Begin pruning Jobs.
hunt-dir: No Jobs found to prune.
hunt-dir: Begin pruning Files.
hunt-dir: No Files found to prune.
hunt-dir: End auto prune.
hunt-dir: Start Restore Job RestoreFilesHunt.2003-04-17_13.21.44
hunt-sd: Forward spacing to file 1.
hunt-dir: Bacula 1.30 (14Apr03): 17-Apr-2003 13:54
JobId: 101
Job: RestoreFilesHunt.2003-04-17_13.21.44
Client: sauvegarde-fd
Start time: 17-Apr-2003 13:21
End time: 17-Apr-2003 13:54
Files Restored: 1
Bytes Restored: 10,056,130,560
Rate: 5073.7 KB/s
FD termination status: OK
Termination: Restore OK
hunt-dir: Begin pruning Jobs.
hunt-dir: No Jobs found to prune.
hunt-dir: Begin pruning Files.
hunt-dir: No Files found to prune.
hunt-dir: End auto prune.
```

35.18 Restoring to a Running System

If for some reason you want to do a Full restore to a system that has a working kernel (not recommended), you will need to take care not to overwrite the following files:

```
/etc/grub.conf
/etc/X11/Conf
/etc/fstab
/etc/mtab
/lib/modules
/usr/modules
/usr/X11R6
/etc/modules.conf
```

35.19 Additional Resources

Many thanks to Charles Curley who wrote Linux Complete Backup and Recovery HOWTO for the The Linux Documentation Project . This is an excellent document on how to do Bare Metal Recovery on Linux systems, and it was this document that made me realize that Bacula could do the same thing.

You can find quite a few additional resources, both commercial and free at Storage Mountain , formerly known as Backup Central.

And finally, the O'Reilly book, "Unix Backup & Recovery" by W. Curtis Preston covers virtually every backup and recovery topic including bare metal recovery for a large range of Unix systems.





Chapter 36

Bacula TLS – Communications Encryption

Bacula TLS (Transport Layer Security) is built-in network encryption code to provide secure network transport similar to that offered by **stunnel** or **ssh**. The data written to Volumes by the Storage daemon is not encrypted by this code. For data encryption, please see the Data Encryption Chapter of this manual.

The Bacula encryption implementations were written by Landon Fuller.

Supported features of this code include:

- Client/Server TLS Requirement Negotiation
- TLSv1 Connections with Server and Client Certificate Validation
- Forward Secrecy Support via Diffie-Hellman Ephemeral Keying

This document will refer to both "server" and "client" contexts. These terms refer to the accepting and initiating peer, respectively.

Diffie-Hellman anonymous ciphers are not supported by this code. The use of DH anonymous ciphers increases the code complexity and places explicit trust upon the two-way CRAM-MD5 implementation. CRAM-MD5 is subject to known plaintext attacks, and it should be considered considerably less secure than PKI certificate-based authentication.

Appropriate autoconf macros have been added to detect and use OpenSSL if enabled on the `./configure` line with `--with-openssl`

36.1 TLS Configuration Directives

Additional configuration directives have been added to all the daemons (Director, File daemon, and Storage daemon) as well as the various different Console programs. These new directives are defined as follows:

TLS Enable = `<yes—no>` Enable TLS support. If TLS is not enabled, none of the other TLS directives have any effect. In other words, even if you set **TLS Require** = **yes** you need to have TLS enabled or TLS will not be used.

TLS Require = `<yes—no>` Require TLS connections. This directive is ignored unless **TLS Enable** is set to **yes**. If TLS is not required, and TLS is enabled, then Bacula will connect with other daemons either with or without TLS depending on what the other daemon requests. If TLS is enabled and TLS is required, then Bacula will refuse any connection that does not use TLS.

TLS Certificate = `<Filename>` The full path and filename of a PEM encoded TLS certificate. It can be used as either a client or server certificate. PEM stands for Privacy Enhanced Mail, but in this context refers to how the certificates are encoded. It is used because PEM files are base64 encoded and hence ASCII text based rather than binary. They may also contain encrypted information.

TLS Key = `<Filename>` The full path and filename of a PEM encoded TLS private key. It must correspond to the TLS certificate.

TLS Verify Peer = `<yes—no>` Verify peer certificate. Instructs server to request and verify the client's x509 certificate. Any client certificate signed by a known-CA will be accepted unless the **TLS Allowed CN** configuration directive is used, in which case the client certificate must correspond to the Allowed Common Name specified. This directive is valid only for a server and not in a client context.



TLS Allowed CN = <string list> Common name attribute of allowed peer certificates. If this directive is specified, all server certificates will be verified against this list. This can be used to ensure that only the CA-approved Director may connect. This directive may be specified more than once.

TLS CA Certificate File = <Filename> The full path and filename specifying a PEM encoded TLS CA certificate(s). Multiple certificates are permitted in the file. One of *TLS CA Certificate File* or *TLS CA Certificate Dir* are required in a server context if *TLS Verify Peer* (see above) is also specified, and are always required in a client context.

TLS CA Certificate Dir = <Directory> Full path to TLS CA certificate directory. In the current implementation, certificates must be stored PEM encoded with OpenSSL-compatible hashes, which is the subject name's hash and an extension of **.0**. One of *TLS CA Certificate File* or *TLS CA Certificate Dir* are required in a server context if *TLS Verify Peer* is also specified, and are always required in a client context.

TLS DH File = <Directory> Path to PEM encoded Diffie-Hellman parameter file. If this directive is specified, DH key exchange will be used for the ephemeral keying, allowing for forward secrecy of communications. DH key exchange adds an additional level of security because the key used for encryption/decryption by the server and the client is computed on each end and thus is never passed over the network if Diffie-Hellman key exchange is used. Even if DH key exchange is not used, the encryption/decryption key is always passed encrypted. This directive is only valid within a server context.

To generate the parameter file, you may use openssl:

```
openssl dhparam -out dh1024.pem -5 1024
```

36.2 Creating a Self-signed Certificate

You may create a self-signed certificate for use with the Bacula TLS that will permit you to make it function, but will not allow certificate validation. The .pem file containing both the certificate and the key valid for ten years can be made with the following:

```
openssl req -new -x509 -nodes -out bacula.pem -keyout bacula.pem -days 3650
```

The above script will ask you a number of questions. You may simply answer each of them by entering a return, or if you wish you may enter your own data.

Note, however, that self-signed certificates will only work for the outgoing end of connections. For example, in the case of the Director making a connection to a File Daemon, the File Daemon may be configured to allow self-signed certificates, but the certificate used by the Director must be signed by a certificate that is explicitly trusted on the File Daemon end.

This is necessary to prevent “man in the middle” attacks from tools such as ettercap . Essentially, if the Director does not verify that it is talking to a trusted remote endpoint, it can be tricked into talking to a malicious 3rd party who is relaying and capturing all traffic by presenting its own certificates to the Director and File Daemons. The only way to prevent this is by using trusted certificates, so that the man in the middle is incapable of spoofing the connection using his own.

To get a trusted certificate (CA or Certificate Authority signed certificate), you will either need to purchase certificates signed by a commercial CA or find a friend that has setup his own CA or become a CA yourself, and thus you can sign all your own certificates. The book *OpenSSL* by John Viega, Matt Mesier & Pravir Chandra from O'Reilly explains how to do it, or you can read the documentation provided in the Open-source PKI Book project at Source Forge: <http://ospkibook.sourceforge.net/docs/OSPki-2.4.7/OSPki-html/ospki-book.htm> . Note, this link may change.

The program TinyCA has a very nice Graphical User Interface that allows you to easily setup and maintain your own CA. TinyCA can be found at <http://tinyca.sm-zone.net/> .

36.3 Getting a CA Signed Certificate

The process of getting a certificate that is signed by a CA is quite a bit more complicated. You can purchase one from quite a number of PKI vendors, but that is not at all necessary for use with Bacula. To get a CA signed certificate, you will either need to find a friend that has setup his own CA or to become a CA yourself, and thus you can sign all your own certificates. The book *OpenSSL* by John Viega,



Matt Mesier & Pravir Chandra from O'Reilly explains how to do it, or you can read the documentation provided in the Open-source PKI Book project at Source Forge: <http://ospkibook.sourceforge.net/docs/OSPki-2.4.7/OSPki-html/ospki-book.htm> . Note, this link may change.

36.4 Example TLS Configuration Files

Landon has supplied us with the TLS portions of his configuration files, which should help you setting up your own. Note, this example shows the directives necessary for a Director to Storage daemon session. The technique is the same between the Director and the Client and for bconsole to the Director.

bacula-dir.conf

```
Director {
    # define myself
    Name = backup1-dir
    ...
    TLS Enable = yes
    TLS Require = yes
    TLS Verify Peer = yes
    TLS Allowed CN = "bacula@backup1.example.com"
    TLS Allowed CN = "administrator@example.com"
    TLS CA Certificate File = /usr/local/etc/ssl/ca.pem
    # This is a server certificate, used for incoming
    # console connections.
    TLS Certificate = /usr/local/etc/ssl/backup1/cert.pem
    TLS Key = /usr/local/etc/ssl/backup1/key.pem
}

Storage {
    Name = File
    Address = backup1.example.com
    ...
    TLS Require = yes
    TLS CA Certificate File = /usr/local/etc/ssl/ca.pem
    # This is a client certificate, used by the director to
    # connect to the storage daemon
    TLS Certificate = /usr/local/etc/ssl/bacula@backup1/cert.pem
    TLS Key = /usr/local/etc/ssl/bacula@backup1/key.pem
}

Client {
    Name = backup1-fd
    Address = server1.example.com
    ...

    TLS Enable = yes
    TLS Require = yes
    TLS CA Certificate File = /usr/local/etc/ssl/ca.pem
}
```

bacula-fd.conf

```
Director {
    Name = backup1-dir
    ...
    TLS Enable = yes
    TLS Require = yes
    TLS Verify Peer = yes
    # Allow only the Director to connect
    TLS Allowed CN = "bacula@backup1.example.com"
    TLS CA Certificate File = /usr/local/etc/ssl/ca.pem
    # This is a server certificate. It is used by connecting
    # directors to verify the authenticity of this file daemon
    TLS Certificate = /usr/local/etc/ssl/server1/cert.pem
    TLS Key = /usr/local/etc/ssl/server1/key.pem
}

FileDaemon {
    Name = backup1-fd
    ...
    # you need these TLS entries so the SD and FD can
    # communicate
    TLS Enable = yes
    TLS Require = yes
}
```



```
TLS CA Certificate File = /usr/local/etc/ssl/ca.pem
TLS Certificate = /usr/local/etc/ssl/server1/cert.pem
TLS Key = /usr/local/etc/ssl/server1/key.pem
}
```

bacula-sd.conf

```
Storage {                                # definition of myself
  Name = backup1-sd
  ...
  # These TLS configuration options are used for incoming
  # file daemon connections. Director TLS settings are handled
  # below.
  TLS Enable = yes
  TLS Require = yes
  # Peer certificate is not required/requested -- peer validity
  # is verified by the storage connection cookie provided to the
  # File Daemon by the director.
  TLS Verify Peer = no
  TLS CA Certificate File = /usr/local/etc/ssl/ca.pem
  # This is a server certificate. It is used by connecting
  # file daemons to verify the authenticity of this storage daemon
  TLS Certificate = /usr/local/etc/ssl/backup1/cert.pem
  TLS Key = /usr/local/etc/ssl/backup1/key.pem
}

#
# List Directors who are permitted to contact Storage daemon
#
Director {
  Name = backup1-dir
  ...
  TLS Enable = yes
  TLS Require = yes
  # Require the connecting director to provide a certificate
  # with the matching CN.
  TLS Verify Peer = yes
  TLS Allowed CN = "bacula@backup1.example.com"
  TLS CA Certificate File = /usr/local/etc/ssl/ca.pem
  # This is a server certificate. It is used by the connecting
  # director to verify the authenticity of this storage daemon
  TLS Certificate = /usr/local/etc/ssl/backup1/cert.pem
  TLS Key = /usr/local/etc/ssl/backup1/key.pem
}
```



Chapter 37

Data Encryption

Bacula permits file data encryption and signing within the File Daemon (or Client) prior to sending data to the Storage Daemon. Upon restoration, file signatures are validated and any mismatches are reported. At no time does the Director or the Storage Daemon have access to unencrypted file contents.

It is very important to specify what this implementation does NOT do:

- There is one important restore problem to be aware of, namely, it's possible for the director to restore new keys or a Bacula configuration file to the client, and thus force later backups to be made with a compromised key and/or with no encryption at all. You can avoid this by not changing the location of the keys in your Bacula File daemon configuration file, and not changing your File daemon keys. If you do change either one, you must ensure that no restore is done that restores the old configuration or the old keys. In general, the worst effect of this will be that you can no longer connect the File daemon.
- The implementation does not encrypt file metadata such as file path names, permissions, and ownership. Extended attributes are also currently not encrypted. However, Mac OS X resource forks are encrypted.

Encryption and signing are implemented using RSA private keys coupled with self-signed x509 public certificates. This is also sometimes known as PKI or Public Key Infrastructure.

Each File Daemon should be given its own unique private/public key pair. In addition to this key pair, any number of "Master Keys" may be specified – these are key pairs that may be used to decrypt any backups should the File Daemon key be lost. Only the Master Key's public certificate should be made available to the File Daemon. Under no circumstances should the Master Private Key be shared or stored on the Client machine.

The Master Keys should be backed up to a secure location, such as a CD placed in a fire-proof safe or bank safety deposit box. The Master Keys should never be kept on the same machine as the Storage Daemon or Director if you are worried about an unauthorized party compromising either machine and accessing your encrypted backups.

While less critical than the Master Keys, File Daemon Keys are also a prime candidate for off-site backups; burn the key pair to a CD and send the CD home with the owner of the machine.

NOTE!!! If you lose your encryption keys, backups will be unrecoverable. **ALWAYS** store a copy of your master keys in a secure, off-site location.

The basic algorithm used for each backup session (Job) is:

1. The File daemon generates a session key.
2. The FD encrypts that session key via PKE for all recipients (the file daemon, any master keys).
3. The FD uses that session key to perform symmetric encryption on the data.

37.1 Building Bacula with Encryption Support

The configuration option for enabling OpenSSL encryption support has not changed since Bacula 1.38. To build Bacula with encryption support, you will need the OpenSSL libraries and headers installed. When configuring Bacula, use:

```
./configure --with-openssl ...
```



37.2 Encryption Technical Details

The implementation uses 128bit AES-CBC, with RSA encrypted symmetric session keys. The RSA key is user supplied. If you are running OpenSSL 0.9.8 or later, the signed file hash uses SHA-256 – otherwise, SHA-1 is used.

End-user configuration settings for the algorithms are not currently exposed – only the algorithms listed above are used. However, the data written to Volume supports arbitrary symmetric, asymmetric, and digest algorithms for future extensibility, and the back-end implementation currently supports:

Symmetric Encryption:

- 128, 192, and 256-bit AES-CBC
- Blowfish-CBC

Asymmetric Encryption (used to encrypt symmetric session keys):

- RSA

Digest Algorithms:

- MD5
- SHA1
- SHA256
- SHA512

The various algorithms are exposed via an entirely re-usable, OpenSSL-agnostic API (ie, it is possible to drop in a new encryption backend). The Volume format is DER-encoded ASN.1, modeled after the Cryptographic Message Syntax from RFC 3852. Unfortunately, using CMS directly was not possible, as at the time of coding a free software streaming DER decoder/encoder was not available.

37.3 Decrypting with a Master Key

It is preferable to retain a secure, non-encrypted copy of the client's own encryption keypair. However, should you lose the client's keypair, recovery with the master keypair is possible.

You must:

- Concatenate the master private and public key into a single keypair file, ie: `cat master.key master.cert >master.keypair`
- Set the PKI Keypair statement in your bacula configuration file:

```
PKI Keypair = master.keypair
```

- Start the restore. The master keypair will be used to decrypt the file data.

37.4 Generating Private/Public Encryption Keys

Generate a Master Key Pair with:

```
openssl genrsa -out master.key 2048
openssl req -new -key master.key -x509 -out master.cert
```

Generate a File Daemon Key Pair for each FD:

```
openssl genrsa -out fd-example.key 2048
openssl req -new -key fd-example.key -x509 -out fd-example.cert
cat fd-example.key fd-example.cert >fd-example.pem
```

Note, there seems to be a lot of confusion around the file extensions given to these keys. For example, a .pem file can contain all the following: private keys (RSA and DSA), public keys (RSA and DSA) and (x509) certificates. It is the default format for OpenSSL. It stores data Base64 encoded DER format, surrounded by ASCII headers, so is suitable for text mode transfers between systems. A .pem file may contain any number of keys either public or private. We use it in cases where there is both a public and a private key. Typically, above we have used the .cert extension to refer to X509 certificate encoding that contains only a single public key.



37.5 Example Data Encryption Configuration

bacula-fd.conf

```
FileDaemon {
  Name = example-fd
  FDport = 9102                # where we listen for the director
  WorkingDirectory = /var/bacula/working
  Pid Directory = /var/run
  Maximum Concurrent Jobs = 20

  PKI Signatures = Yes        # Enable Data Signing
  PKI Encryption = Yes       # Enable Data Encryption
  PKI Keypair = "/etc/bacula/fd-example.pem" # Public and Private Keys
  PKI Master Key = "/etc/bacula/master.cert" # ONLY the Public Key
}
```





Chapter 38

Using Bacula to Improve Computer Security

Since Bacula maintains a catalog of files, their attributes, and either SHA1 or MD5 signatures, it can be an ideal tool for improving computer security. This is done by making a snapshot of your system files with a **Verify Job** and then checking the current state of your system against the snapshot, on a regular basis (e.g. nightly).

The first step is to set up a **Verify Job** and to run it with:

```
Level = InitCatalog
```

The **InitCatalog** level tells **Bacula** simply to get the information on the specified files and to put it into the catalog. That is your database is initialized and no comparison is done. The **InitCatalog** is normally run one time manually.

Thereafter, you will run a **Verify Job** on a daily (or whatever) basis with:

```
Level = Catalog
```

The **Level = Catalog** level tells Bacula to compare the current state of the files on the Client to the last **InitCatalog** that is stored in the catalog and to report any differences. See the example below for the format of the output.

You decide what files you want to form your "snapshot" by specifying them in a **FileSet** resource, and normally, they will be system files that do not change, or that only certain features change.

Then you decide what attributes of each file you want compared by specifying comparison options on the **Include** statements that you use in the **FileSet** resource of your **Catalog Jobs**.

38.1 The Details

In the discussion that follows, we will make reference to the **Verify Configuration Example** that is included below in the **A Verify Configuration Example** section. You might want to look it over now to get an idea of what it does.

The main elements consist of adding a schedule, which will normally be run daily, or perhaps more often. This is provided by the **VerifyCycle** Schedule, which runs at 5:05 in the morning every day.

Then you must define a Job, much as is done below. We recommend that the Job name contain the name of your machine as well as the word **Verify** or **Check**. In our example, we named it **MatouVerify**. This will permit you to easily identify your job when running it from the Console.

You will notice that most records of the Job are quite standard, but that the **FileSet** resource contains **verify=pins1** option in addition to the standard **signature=SHA1** option. If you don't want SHA1 signature comparison, and we cannot imagine why not, you can drop the **signature=SHA1** and none will be computed nor stored in the catalog. Or alternatively, you can use **verify=pins5** and **signature=MD5**, which will use the MD5 hash algorithm. The MD5 hash computes faster than SHA1, but is cryptographically less secure.

The **verify=pins1** is ignored during the **InitCatalog** Job, but is used during the subsequent **Catalog Jobs** to specify what attributes of the files should be compared to those found in the catalog. **pins1** is a reasonable set to begin with, but you may want to look at the details of these and other options. They can be found in the **FileSet Resource** section of this manual. Briefly, however, the **p** of the **pins1** tells Verify to compare the permissions bits, the **i** is to compare inodes, the **n** causes comparison of the number of links,



the **s** compares the file size, and the **1** compares the SHA1 checksums (this requires the **signature=SHA1** option to have been set also).

You must also specify the **Client** and the **Catalog** resources for your Verify job, but you probably already have them created for your client and do not need to recreate them, they are included in the example below for completeness.

As mentioned above, you will need to have a **FileSet** resource for the Verify job, which will have the additional **verify=pins1** option. You will want to take some care in defining the list of files to be included in your **FileSet**. Basically, you will want to include all system (or other) files that should not change on your system. If you select files, such as log files or mail files, which are constantly changing, your automatic Verify job will be constantly finding differences. The objective in forming the FileSet is to choose all unchanging important system files. Then if any of those files has changed, you will be notified, and you can determine if it changed because you loaded a new package, or because someone has broken into your computer and modified your files. The example below shows a list of files that I use on my Red Hat 7.3 system. Since I didn't spend a lot of time working on it, it probably is missing a few important files (if you find one, please send it to me). On the other hand, as long as I don't load any new packages, none of these files change during normal operation of the system.

38.2 Running the Verify

The first thing you will want to do is to run an **InitCatalog** level Verify Job. This will initialize the catalog to contain the file information that will later be used as a basis for comparisons with the actual file system, thus allowing you to detect any changes (and possible intrusions into your system).

The easiest way to run the **InitCatalog** is manually with the console program by simply entering **run**. You will be presented with a list of Jobs that can be run, and you will choose the one that corresponds to your Verify Job, **MatouVerify** in this example.

```
The defined Job resources are:
```

- 1: MatouVerify
- 2: kernsrestore
- 3: Filetest
- 4: kernsave

```
Select Job resource (1-4): 1
```

Next, the console program will show you the basic parameters of the Job and ask you:

```
Run Verify job
JobName: MatouVerify
FileSet: Verify Set
Level: Catalog
Client: MatouVerify
Storage: DLTDDrive
Verify Job:
Verify List: /tmp/regress/working/MatouVerify.bsr
OK to run? (yes/mod/no): mod
```

Here, you want to respond **mod** to modify the parameters because the Level is by default set to **Catalog** and we want to run an **InitCatalog** Job. After responding **mod**, the console will ask:

```
Parameters to modify:
```

- 1: Level
- 2: Storage
- 3: Job
- 4: FileSet
- 5: Client
- 6: When
- 7: Priority
- 8: Pool
- 9: Verify Job

```
Select parameter to modify (1-5): 1
```

you should select number 2 to modify the **Level**, and it will display:

```
Levels:
1: Initialize Catalog
2: Verify Catalog
3: Verify Volume to Catalog
4: Verify Disk to Catalog
5: Verify Volume Data (not yet implemented)
Select level (1-4): 1
```



Choose item 1, and you will see the final display:

```
Run Verify job
JobName: MatouVerify
FileSet: Verify Set
Level: Initcatalog
Client: MatouVerify
Storage: DLTDrive
Verify Job:
Verify List: /tmp/regress/working/MatouVerify.bsr
OK to run? (yes/mod/no): yes
```

at which point you respond **yes**, and the Job will begin.

Thereafter the Job will automatically start according to the schedule you have defined. If you wish to immediately verify it, you can simply run a Verify **Catalog** which will be the default. No differences should be found.

To use a previous job, you can add `jobid=xxx` option in run command line. It will run the Verify job against the specified job.

```
*run jobid=1 job=MatouVerify
Run Verify job
JobName: MatouVerify
Level: Catalog
Client: 127.0.0.1-fd
FileSet: Full Set
Pool: Default (From Job resource)
Storage: File (From Job resource)
Verify Job: MatouVerify.2010-09-08_15.33.33_03
Verify List: /tmp/regress/working/MatouVerify.bsr
When: 2010-09-08 15:35:32
Priority: 10
OK to run? (yes/mod/no):
```

38.3 What To Do When Differences Are Found

If you have setup your messages correctly, you should be notified if there are any differences and exactly what they are. For example, below is the email received after doing an update of OpenSSH:

```
HeadMan: Start Verify JobId 83 Job=RufusVerify.2002-06-25.21:41:05
HeadMan: Verifying against Init JobId 70 run 2002-06-21 18:58:51
HeadMan: File: /etc/pam.d/sshd
HeadMan: st_ino differ. Cat: 4674b File: 46765
HeadMan: File: /etc/rc.d/init.d/sshd
HeadMan: st_ino differ. Cat: 56230 File: 56231
HeadMan: File: /etc/ssh/ssh_config
HeadMan: st_ino differ. Cat: 81317 File: 8131b
HeadMan: st_size differ. Cat: 1202 File: 1297
HeadMan: SHA1 differs.
HeadMan: File: /etc/ssh/sshd_config
HeadMan: st_ino differ. Cat: 81398 File: 81325
HeadMan: st_size differ. Cat: 1182 File: 1579
HeadMan: SHA1 differs.
HeadMan: File: /etc/ssh/ssh_config.rpmnew
HeadMan: st_ino differ. Cat: 812dd File: 812b3
HeadMan: st_size differ. Cat: 1167 File: 1114
HeadMan: SHA1 differs.
HeadMan: File: /etc/ssh/sshd_config.rpmnew
HeadMan: st_ino differ. Cat: 81397 File: 812dd
HeadMan: st_size differ. Cat: 2528 File: 2407
HeadMan: SHA1 differs.
HeadMan: File: /etc/ssh/moduli
HeadMan: st_ino differ. Cat: 812b3 File: 812ab
HeadMan: File: /usr/bin/scp
HeadMan: st_ino differ. Cat: 5e07e File: 5e343
HeadMan: st_size differ. Cat: 26728 File: 26952
HeadMan: SHA1 differs.
HeadMan: File: /usr/bin/ssh-keygen
HeadMan: st_ino differ. Cat: 5df1d File: 5e07e
HeadMan: st_size differ. Cat: 80488 File: 84648
```



```

HeadMan:      SHA1 differs.
HeadMan: File: /usr/bin/sftp
HeadMan:      st_ino   differ. Cat: 5e2e8 File: 5df1d
HeadMan:      st_size  differ. Cat: 46952 File: 46984
HeadMan:      SHA1 differs.
HeadMan: File: /usr/bin/slogin
HeadMan:      st_ino   differ. Cat: 5e359 File: 5e2e8
HeadMan: File: /usr/bin/ssh
HeadMan:      st_mode  differ. Cat: 89ed File: 81ed
HeadMan:      st_ino   differ. Cat: 5e35a File: 5e359
HeadMan:      st_size  differ. Cat: 219932 File: 234440
HeadMan:      SHA1 differs.
HeadMan: File: /usr/bin/ssh-add
HeadMan:      st_ino   differ. Cat: 5e35b File: 5e35a
HeadMan:      st_size  differ. Cat: 76328 File: 81448
HeadMan:      SHA1 differs.
HeadMan: File: /usr/bin/ssh-agent
HeadMan:      st_ino   differ. Cat: 5e35c File: 5e35b
HeadMan:      st_size  differ. Cat: 43208 File: 47368
HeadMan:      SHA1 differs.
HeadMan: File: /usr/bin/ssh-keyscan
HeadMan:      st_ino   differ. Cat: 5e35d File: 5e96a
HeadMan:      st_size  differ. Cat: 139272 File: 151560
HeadMan:      SHA1 differs.
HeadMan: 25-Jun-2002 21:41
JobId:        83
Job:          RufusVerify.2002-06-25.21:41:05
FileSet:      Verify Set
Verify Level: Catalog
Client:       RufusVerify
Start time:   25-Jun-2002 21:41
End time:     25-Jun-2002 21:41
Files Examined: 4,258
Termination: Verify Differences

```

At this point, it was obvious that these files were modified during installation of the RPMs. If you want to be super safe, you should run a **Verify Level=Catalog** immediately before installing new software to verify that there are no differences, then run a **Verify Level=InitCatalog** immediately after the installation.

To keep the above email from being sent every night when the Verify Job runs, we simply re-run the Verify Job setting the level to **InitCatalog** (as we did above in the very beginning). This will re-establish the current state of the system as your new basis for future comparisons. Take care that you don't do an **InitCatalog** after someone has placed a Trojan horse on your system!

If you have included in your **FileSet** a file that is changed by the normal operation of your system, you will get false matches, and you will need to modify the **FileSet** to exclude that file (or not to Include it), and then re-run the **InitCatalog**.

The FileSet that is shown below is what I use on my Red Hat 7.3 system. With a bit more thought, you can probably add quite a number of additional files that should be monitored.

38.4 A Verify Configuration Example

```

Schedule {
  Name = "VerifyCycle"
  Run = Level=Catalog sun-sat at 5:05
}
Job {
  Name = "MatouVerify"
  Type = Verify
  Level = Catalog          # default level
  Client = MatouVerify
  FileSet = "Verify Set"
  Messages = Standard
  Storage = DLTDrive
  Pool = Default
  Schedule = "VerifyCycle"
}
#
# The list of files in this FileSet should be carefully
# chosen. This is a good starting point.
#
FileSet {
  Name = "Verify Set"

```



```
Include {
  Options {
    verify=pins1
    signature=SHA1
  }
  File = /boot
  File = /bin
  File = /sbin
  File = /usr/bin
  File = /lib
  File = /root/.ssh
  File = /home/kern/.ssh
  File = /var/named
  File = /etc/sysconfig
  File = /etc/ssh
  File = /etc/security
  File = /etc/exports
  File = /etc/rc.d/init.d
  File = /etc/sendmail.cf
  File = /etc/sysctl.conf
  File = /etc/services
  File = /etc/xinetd.d
  File = /etc/hosts.allow
  File = /etc/hosts.deny
  File = /etc/hosts
  File = /etc/modules.conf
  File = /etc/named.conf
  File = /etc/pam.d
  File = /etc/resolv.conf
}
Exclude = { }
P
Client {
  Name = MatouVerify
  Address = lmatou
  Catalog = Bacula
  Password = ""
  File Retention = 80d           # 80 days
  Job Retention = 1y            # one year
  AutoPrune = yes               # Prune expired Jobs/Files
}
Catalog {
  Name = Bacula
  dbname = verify; user = bacula; password = ""
}
```





Chapter 39

Installing and Configuring MySQL

39.1 Installing and Configuring MySQL – Phase I

If you use the `./configure --with-mysql=mysql-directory` statement for configuring **Bacula**, you will need MySQL version 4.1 or later installed in the **mysql-directory**. If you are using one of the new modes such as ANSI/ISO compatibility, you may experience problems.

If MySQL is installed in the standard system location, you need only enter `--with-mysql` since the configure program will search all the standard locations. If you install MySQL in your home directory or some other non-standard directory, you will need to provide the full path to it.

Installing and Configuring MySQL is not difficult but can be confusing the first time. As a consequence, below, we list the steps that we used to install it on our machines. Please note that our configuration leaves MySQL without any user passwords. This may be an undesirable situation if you have other users on your system.

The notes below describe how to build MySQL from the source tar files. If you have a pre-installed MySQL, you can return to complete the installation of Bacula, then come back to Phase II of the MySQL installation. If you wish to install MySQL from rpms, you will probably need to install the following:

```
mysql-<version>.rpm
mysql-server-<version>.rpm
mysql-devel-<version>.rpm
```

If you wish to install them from debs, you will probably need the following:

```
mysql-server-<version>.deb
mysql-client-<version>.deb
libmysqlclient15-dev-<version>.deb
libmysqlclient15off-<version>.deb
```

The names of the packages may vary from distribution to distribution. It is important to have the **devel** or **dev** package loaded as it contains the libraries and header files necessary to build Bacula. There may be additional packages that are required to install the above, for example, `zlib` and `openssl`.

Once these packages are installed, you will be able to build Bacula (using the files installed with the `mysql` package, then run MySQL using the files installed with `mysql-server`. If you have installed MySQL by debs or rpms, please skip Phase I below, and return to complete the installation of Bacula, then come back to Phase II of the MySQL installation when indicated to do so.

Beginning with Bacula version 1.31, the thread safe version of the MySQL client library is used, and hence you should add the `--enable-thread-safe-client` option to the `./configure` as shown below:

1. Download MySQL source code from www.mysql.com/downloads
2. Detar it with something like:

```
tar xvfz mysql-filename
```

Note, the above command requires GNU tar. If you do not have GNU tar, a command such as:

```
zcat mysql-filename | tar xvf -
```

will probably accomplish the same thing.

3. cd **mysql-source-directory**

where you replace **mysql-source-directory** with the directory name where you put the MySQL source code.



4. `./configure --enable-thread-safe-client --prefix=mysql-directory`
where you replace **mysql-directory** with the directory name where you want to install mysql. Normally for system wide use this is `/usr/local/mysql`. In my case, I use `~kern/mysql`.
5. `make`
This takes a bit of time.
6. `make install`
This will put all the necessary binaries, libraries and support files into the **mysql-directory** that you specified above.
7. `./scripts/mysql_install_db`
This will create the necessary MySQL databases for controlling user access. Note, this script can also be found in the **bin** directory in the installation directory

The MySQL client library **mysqlclient** requires the gzip compression library **libz.a** or **libz.so**. If you are using rpm packages, these libraries are in the **libz-devel** package. On Debian systems, you will need to load the **zlib1g-dev** package. If you are not using rpms or debs, you will need to find the appropriate package for your system.

At this point, you should return to completing the installation of **Bacula**. Later after Bacula is installed, come back to this chapter to complete the installation. Please note, the installation files used in the second phase of the MySQL installation are created during the Bacula Installation.

39.2 Installing and Configuring MySQL – Phase II

At this point, you should have built and installed MySQL, or already have a running MySQL, and you should have configured, built and installed **Bacula**. If not, please complete these items before proceeding. Please note that the `./configure` used to build **Bacula** will need to include `--with-mysql=mysql-directory`, where **mysql-directory** is the directory name that you specified on the `./configure` command for configuring MySQL. This is needed so that Bacula can find the necessary include headers and library files for interfacing to MySQL.

Bacula will install scripts for manipulating the database (create, delete, make tables etc) into the main installation directory. These files will be of the form `*.bacula_*` (e.g. `create_bacula_database`). These files are also available in the `<bacula-src>/src/cats` directory after running `./configure`. If you inspect `create_bacula_database`, you will see that it calls `create_mysql_database`. The `*.bacula_*` files are provided for convenience. It doesn't matter what database you have chosen; `create_bacula_database` will always create your database.

Now you will create the Bacula MySQL database and the tables that Bacula uses.

1. Start **mysql**. You might want to use the **startmysql** script provided in the Bacula release.
2. `cd <install-directory>` This directory contains the Bacula catalog interface routines.
3. `./grant_mysql_privileges` This script creates unrestricted access rights for the user **bacula**. You may want to modify it to suit your situation. Please note that none of the userids, including root, are password protected. If you need more security, please assign a password to the root user and to bacula. The program **mysqladmin** can be used for this.
4. `./create_mysql_database` This script creates the MySQL **bacula** database. The databases you create as well as the access databases will be located in `<install-dir>/var/` in a subdirectory with the name of the database, where `<install-dir>` is the directory name that you specified on the `--prefix` option. This can be important to know if you want to make a special backup of the Bacula database or to check its size.
5. `./make_mysql_tables` This script creates the MySQL tables used by **Bacula**.

Each of the three scripts (`grant_mysql_privileges`, `create_mysql_database` and `make_mysql_tables`) allows the addition of a command line argument. This can be useful for specifying the user and or password. For example, you might need to add `-u root` to the command line to have sufficient privilege to create the Bacula tables.

To take a closer look at the access privileges that you have setup with the above, you can do:

```
mysql-directory/bin/mysql -u root mysql
select * from user;
```



39.3 Re-initializing the Catalog Database

After you have done some initial testing with **Bacula**, you will probably want to re-initialize the catalog database and throw away all the test Jobs that you ran. To do so, you can do the following:

```
cd <install-directory>
./drop_mysql_tables
./make_mysql_tables
```

Please note that all information in the database will be lost and you will be starting from scratch. If you have written on any Volumes, you must write an end of file mark on the volume so that Bacula can reuse it. Do so with:

```
(stop Bacula or unmount the drive)
mt -f /dev/nst0 rewind
mt -f /dev/nst0 weof
```

Where you should replace `/dev/nst0` with the appropriate tape drive device name for your machine.

39.4 Linking Bacula with MySQL

After configuring Bacula with

```
./configure --enable-thread-safe-client --prefix=<mysql-directory>
```

where `<mysql-directory>` is in my case `/home/kern/mysql`, you may have to configure the loader so that it can find the MySQL shared libraries. If you have previously followed this procedure and later add the `--enable-thread-safe-client` options, you will need to rerun the `ldconfig` program shown below. If you put MySQL in a standard place such as `/usr/lib` or `/usr/local/lib` this will not be necessary, but in my case it is. The description that follows is Linux specific. For other operating systems, please consult your manuals on how to do the same thing: First edit: `/etc/ld.so.conf` and add a new line to the end of the file with the name of the `mysql-directory`. In my case, it is:

`/home/kern/mysql/lib/mysql` then rebuild the loader's cache with:

`/sbin/ldconfig` If you upgrade to a new version of **MySQL**, the shared library names will probably change, and you must re-run the `/sbin/ldconfig` command so that the runtime loader can find them.

Alternatively, your system may have a loader environment variable that can be set. For example, on a Solaris system where I do not have root permission, I use:

```
LD_LIBRARY_PATH=/home/kern/mysql/lib/mysql
```

Finally, if you have encryption enabled in MySQL, you may need to add `-lssl -lcrypto` to the link. In that case, you can either export the appropriate `LD_FLAGS` definition, or alternatively, you can include them directly on the `./configure` line as in:

```
LD_FLAGS="-lssl -lcrypto" \
./configure \
<your-options>
```

39.5 Installing MySQL from RPMs

If you are installing MySQL from RPMs, you will need to install both the MySQL binaries and the client libraries. The client libraries are usually found in a `devel` package, so you must install:

```
mysql
mysql-devel
```

This will be the same with most other package managers too.

39.6 Upgrading MySQL

If you upgrade MySQL, you must reconfigure, rebuild, and re-install Bacula otherwise you are likely to get bizarre failures. If you install from `rpms` and you upgrade MySQL, you must also rebuild Bacula. You can do so by rebuilding from the source rpm. To do so, you may need to modify the `bacula.spec` file to account for the new MySQL version.





Chapter 40

Installing and Configuring PostgreSQL

If you are considering using PostgreSQL, you should be aware of their philosophy of upgrades, which could be destabilizing for a production shop. Basically at every major version upgrade, you are required to dump your database in an ASCII format, do the upgrade, and then reload your database (or databases). This is because they frequently update the "data format" from version to version, and they supply no tools to automatically do the conversion. If you forget to do the ASCII dump, your database may become totally useless because none of the new tools can access it due to the format change, and the PostgreSQL server will not be able to start.

If you are building PostgreSQL from source, please be sure to add the `--enable-thread-safety` option when doing the `./configure` for PostgreSQL.

40.1 Installing PostgreSQL

If you use the `./configure --with-postgresql=PostgreSQL-Directory` statement for configuring **Bacula**, you will need PostgreSQL version 7.4 or later installed. NOTE! PostgreSQL versions earlier than 7.4 do not work with Bacula. If PostgreSQL is installed in the standard system location, you need only enter `--with-postgresql` since the configure program will search all the standard locations. If you install PostgreSQL in your home directory or some other non-standard directory, you will need to provide the full path with the `--with-postgresql` option.

Installing and configuring PostgreSQL is not difficult but can be confusing the first time. If you prefer, you may want to use a package provided by your chosen operating system. Binary packages are available on most PostgreSQL mirrors.

If you prefer to install from source, we recommend following the instructions found in the PostgreSQL documentation .

If you are using FreeBSD, this FreeBSD Diary article will be useful. Even if you are not using FreeBSD, the article will contain useful configuration and setup information.

If you configure the Batch Insert code in Bacula (attribute inserts are 10 times faster), you **must** be using a PostgreSQL that was built with the `--enable-thread-safety` option, otherwise you will get data corruption. Most major Linux distros have thread safety turned on, but it is better to check. One way is to see if the PostgreSQL library that Bacula will be linked against references pthreads. This can be done with a command such as:

```
nm /usr/lib/libpq.a | grep pthread_mutex_lock
```

The above command should print a line that looks like:

```
U pthread_mutex_lock
```

if does, then everything is OK. If it prints nothing, do not enable batch inserts when building Bacula.

After installing PostgreSQL, you should return to completing the installation of **Bacula**. Later, after Bacula is installed, come back to this chapter to complete the installation. Please note, the installation files used in the second phase of the PostgreSQL installation are created during the Bacula Installation. You must still come back to complete the second phase of the PostgreSQL installation even if you installed binaries (e.g. rpm, deb, ...).



40.2 Configuring PostgreSQL

At this point, you should have built and installed PostgreSQL, or already have a running PostgreSQL, and you should have configured, built and installed **Bacula**. If not, please complete these items before proceeding.

Please note that the `./configure` used to build **Bacula** will need to include `--with-postgresql=PostgreSQL-directory`, where **PostgreSQL-directory** is the directory name that you specified on the `./configure` command for configuring PostgreSQL (if you didn't specify a directory or PostgreSQL is installed in a default location, you do not need to specify the directory). This is needed so that Bacula can find the necessary include headers and library files for interfacing to PostgreSQL.

An important thing to note here is that **Bacula** makes two connections to the PostgreSQL server for each backup job that is currently running. If you are intending to run a large number of concurrent jobs, check the value of `max_connections` in your PostgreSQL configuration file to ensure that it is larger than the setting **Maximum Concurrent Jobs** in your director configuration. **Setting this too low will result in some backup jobs failing to run correctly!**

Bacula will install scripts for manipulating the database (create, delete, make tables etc) into the main installation directory. These files will be of the form `*_bacula_*` (e.g. `create_bacula_database`). These files are also available in the `<bacula-src>/src/cats` directory after running `./configure`. If you inspect `create_bacula_database`, you will see that it calls `create_postgresql_database`. The `*_bacula_*` files are provided for convenience. It doesn't matter what database you have chosen; `create_bacula_database` will always create your database.

Now you will create the Bacula PostgreSQL database and the tables that Bacula uses. These instructions assume that you already have PostgreSQL running. You will need to perform these steps as a user that is able to create new databases. This can be the PostgreSQL user (on most systems, this is the `pgsql` user).

1. `cd <install-directory>`

This directory contains the Bacula catalog interface routines.

2. Create the database owner (**bacula**) On many systems, the PostgreSQL master owner is **pgsql** and on others such as Red Hat and Fedora it is **postgres**. You can find out which it is by examining your `/etc/passwd` file. To create a new user under either your name or with say the name **bacula**, you can do the following:

```
su
(enter root password)
su postgres (or postgres)
createuser bacula
Shall the new user be allowed to create databases? (y/n) y
Shall the new user be allowed to create more new users? (y/n) (choose
what you want)
exit
```

Normally the **bacula** user must be able to create new databases, if you use the script in the next item, or you will have to create one for it, but it does not need to create new users.

3. `./create_bacula_database`

This script creates the PostgreSQL **bacula** database. Before running this command, you should carefully think about what encoding sequence you want for the text fields (paths, files, ...). We strongly recommend that you use the default value of `SQL_ASCII` that is in the `create_bacula_database` script. Please be warned that if you change this value, your backups may fail. After running the script, you can check with the command:

```
psql -l
```

and the column marked **Encoding** should be **SQL_ASCII** for all your Bacula databases (normally **bacula**).

4. `./make_bacula_tables`

This script creates the PostgreSQL tables used by **Bacula**.



5. ./grant_bacula_privileges

This script creates the database user **bacula** with restricted access rights. You may want to modify it to suit your situation. Please note that this database is not password protected.

Each of the three scripts (`create_bacula_database`, `make_bacula_tables`, and `grant_bacula_privileges`) allows the addition of a command line argument. This can be useful for specifying the user name. For example, you might need to add **-h hostname** to the command line to specify a remote database server.

To take a closer look at the access privileges that you have setup with the above, you can do:

```
PostgreSQL-directory/bin/psql --command \dp bacula
```

Also, I had an authorization problem with the password. In the end, I had to modify my **pg_hba.conf** file (in `/var/lib/pgsql/data` on my machine in `/var/lib/postgresql/8.x` on others, and in `/etc/postgres/8.x/main` on still others – what a mess!) from:

```
local  all  all          ident  sameuser
to
local  all  all          trust
```

This solved the problem for me, but it is not always a good thing to do from a security standpoint. However, it allowed me to run my regression scripts without having a password.

A more secure way to perform database authentication is with md5 password hashes. Begin by editing the **pg_hba.conf** file, and above the existing “local” and “host” lines, add the line:

```
local bacula bacula md5
```

then restart the Postgres database server (frequently, this can be done using “`/etc/init.d/postgresql restart`” or “`service postgresql restart`”) to put this new authentication rule into effect.

Next, become the Postgres administrator, `postgres`, either by logging on as the `postgres` user, or by using `su` to become root and then using **su - postgres** or **su - pgsq** to become `postgres`. Add a password to the **bacula** database for the **bacula** user using:

```
\$ psql bacula
bacula=# alter user bacula with password 'secret';
ALTER USER
bacula=# \q
```

You’ll have to add this password to two locations in the `bacula-dir.conf` file: once to the Catalog resource and once to the `RunBeforeJob` entry in the BackupCatalog Job resource. With the password in place, these two lines should look something like:

```
dbname = bacula; user = bacula; password = "secret"
... and ...
# WARNING!!! Passing the password via the command line is insecure.
# see comments in make_catalog_backup for details.
RunBeforeJob = "/etc/make_catalog_backup bacula bacula secret"
```

Naturally, you should choose your own significantly more random password, and ensure that the `bacula-dir.conf` file containing this password is readable only by the root.

Even with the files containing the database password properly restricted, there is still a security problem with this approach: on some platforms, the environment variable that is used to supply the password to Postgres is available to all users of the local system. To eliminate this problem, the Postgres team have deprecated the use of the environment variable password-passing mechanism and recommend the use of a `.pgpass` file instead. To use this mechanism, create a file named `.pgpass` containing the single line:

```
localhost:5432:bacula:secret
```

This file should be copied into the home directory of all accounts that will need to gain access to the database: typically, root, bacula, and any users who will make use of any of the console programs. The files must then have the owner and group set to match the user (so `root:root` for the copy in root, and so on), and the mode set to 600, limiting access to the owner of the file.



40.3 Re-initializing the Catalog Database

After you have done some initial testing with **Bacula**, you will probably want to re-initialize the catalog database and throw away all the test Jobs that you ran. To do so, you can do the following:

```
cd <install-directory>
./drop_bacula_tables
./make_bacula_tables
./grant_bacula_privileges
```

Please note that all information in the database will be lost and you will be starting from scratch. If you have written on any Volumes, you must write an end of file mark on the volume so that Bacula can reuse it. Do so with:

```
(stop Bacula or unmount the drive)
mt -f /dev/nst0 rewind
mt -f /dev/nst0 weof
```

Where you should replace `/dev/nst0` with the appropriate tape drive device name for your machine.

40.4 Installing PostgreSQL from RPMs

If you are installing PostgreSQL from RPMs, you will need to install both the PostgreSQL binaries and the client libraries. The client libraries are usually found in a **devel** or **dev** package, so you must install the following for rpms:

```
postgresql
postgresql-devel
postgresql-server
postgresql-libs
```

and the following for debs:

```
postgresql
postgresql-common
postgresql-client
postgresql-client-common
libpq5
libpq-dev
```

These will be similar with most other package managers too. After installing from rpms, you will still need to run the scripts that set up the database and create the tables as described above.

40.5 Converting from MySQL to PostgreSQL

The conversion procedure presented here was worked out by Norm Dressler <ndressler at dinmar dot com> This process was tested using the following software versions:

- Linux Ubuntu Lucid
- Mysql Ver 5.0.83
- PostgreSQL 8.4.4
- Bacula 5.0

WARNING: Always as a precaution, take a complete backup of your databases before proceeding with this process!

1. Shutdown bacula (cd /etc/bacula;./bacula stop)
2. Run the following command to dump your Mysql database:

```
mysqldump -t -n -c --compatible=postgresql --skip-quote-names --skip-opt \
--disable-keys --lock-tables -u bacula -ppassword bacula \
| grep -v "INSERT INTO Status" \
| sed -e 's/0000-00-00 00:00:00/1970-01-01 00:00:00/g' \
| sed -e 's/\\0//> bacula-backup.sql
```



3. Make a backup of your `/etc/bacula` directory (but leave the original in place).
4. Go to your Bacula source directory and rebuild it to include PostgreSQL support rather than Mysql support. Check the `config.log` file for your original configure command and replace `enable-mysql` with `enable-postgresql`.
5. Recompile Bacula with a `make` and if everything compiles completely, perform a `make install`.
6. Shutdown Mysql.
7. Start PostgreSQL on your system.
8. Create a bacula user in Postgres with the `createuser` command. Depending on your Postgres install, you may have to `SU` to the user who has privileges to create a user, you can also have to change permissions on catalog scripts to fit your situation.
9. Verify your `pg_hba.conf` file contains sufficient permissions to allow bacula to access the server. Mine has the following since it's on a secure network:

```
local all all trust
```

```
host all all 127.0.0.1 255.255.255.255 trust
```

NOTE: you should reload (or restart) your postgres server if you made changes

10. Change into the `/etc/bacula` directory and prepare the database and tables with the following commands:

```
./create_postgresql_database
```

```
./make_postgresql_tables
```

```
./grant_postgresql_privileges
```

11. Verify you have access to the database:

```
psql -Ubacula bacula
```

You should not get any errors.

12. Load your database from the Mysql database dump with:

```
psql -Ubacula bacula <bacula-backup.dmp>
```

13. Resequence your tables with the following commands:

```
psql -Ubacula bacula
```

```
SELECT SETVAL('basefiles_baseid_seq', (SELECT MAX(baseid) FROM basefiles));
SELECT SETVAL('client_clientid_seq', (SELECT MAX(clientid) FROM client));
SELECT SETVAL('file_fileid_seq', (SELECT MAX(fileid) FROM file));
SELECT SETVAL('filename_filenameid_seq', (SELECT MAX(filenameid) FROM filename));
SELECT SETVAL('fileset_filesetid_seq', (SELECT MAX(filesetid) FROM fileset));
SELECT SETVAL('job_jobid_seq', (SELECT MAX(jobid) FROM job));
SELECT SETVAL('jobmedia_jobmediaid_seq', (SELECT MAX(jobmediaid) FROM jobmedia));
SELECT SETVAL('media_mediaid_seq', (SELECT MAX(mediaid) FROM media));
SELECT SETVAL('path_pathid_seq', (SELECT MAX(pathid) FROM path));
SELECT SETVAL('basefiles_baseid_seq', (SELECT MAX(baseid) FROM basefiles));
SELECT SETVAL('client_clientid_seq', (SELECT MAX(clientid) FROM client));
SELECT SETVAL('file_fileid_seq', (SELECT MAX(fileid) FROM file));
SELECT SETVAL('filename_filenameid_seq', (SELECT MAX(filenameid) FROM filename));
SELECT SETVAL('fileset_filesetid_seq', (SELECT MAX(filesetid) FROM fileset));
SELECT SETVAL('job_jobid_seq', (SELECT MAX(jobid) FROM job));
SELECT SETVAL('jobmedia_jobmediaid_seq', (SELECT MAX(jobmediaid) FROM jobmedia));
```



```
SELECT SETVAL('media_mediaid_seq', (SELECT MAX(mediaid) FROM media));
SELECT SETVAL('path_pathid_seq', (SELECT MAX(pathid) FROM path));
SELECT SETVAL('pool_poolid_seq', (SELECT MAX(poolid) FROM pool));

SELECT SETVAL('device_deviceid_seq', (SELECT MAX(deviceid) FROM device));
SELECT SETVAL('location_locationid_seq', (SELECT MAX(locationid) FROM location));
SELECT SETVAL('locationlog_loclogid_seq', (SELECT MAX(loclogid) FROM locationlog));
SELECT SETVAL('log_logid_seq', (SELECT MAX(logid) FROM log));
SELECT SETVAL('mediatype_mediatypeid_seq', (SELECT MAX(mediatypeid) FROM mediatype));
SELECT SETVAL('storage_storageid_seq', (SELECT MAX(storageid) FROM storage));
```

14. At this point, start up Bacula, verify your volume library and perform a test backup to make sure everything is working properly.

40.6 Upgrading PostgreSQL

If you upgrade PostgreSQL, you must reconfigure, rebuild, and re-install Bacula otherwise you are likely to get bizarre failures. If you to modify the bacula.spec file to account for the new PostgreSQL version. You can do so by rebuilding from the source rpm. To do so, you may need install from rpms and you upgrade PostgreSQL, you must also rebuild Bacula.

40.7 Tuning PostgreSQL

If you despool attributes for many jobs at the same time, you can tune the sequence object for the `FileId` field.

```
psql -Ubacula bacula
```

```
ALTER SEQUENCE file_fileid_seq CACHE 1000;
```

40.8 Credits

Many thanks to Dan Langille for writing the PostgreSQL driver. This will surely become the most popular database that Bacula supports.



Chapter 41

Installing and Configuring SQLite

Please note that SQLite both versions 2 and 3 are not network enabled, which means that they must be linked into the Director rather than accessed by the network as MySQL and PostgreSQL are. This has two consequences:

1. SQLite cannot be used in the **bweb** web GUI package.
2. If you use SQLite, and your Storage daemon is not on the same machine as your Director, you will need to transfer your database to the Storage daemon's machine before you can use any of the SD tools such as **bscan**, ...

41.1 Installing and Configuring SQLite – Phase I

If you use the `./configure --with-sqlite` statement for configuring **Bacula**, you will need SQLite version 2.8.16 or later installed. Our standard location (for the moment) for SQLite is in the dependency package **depkgs/sqlite-2.8.16**. Please note that the version will be updated as new versions are available and tested. Installing and Configuring is quite easy.

1. Download the Bacula dependency packages
2. Detar it with something like:

```
tar xvfz depkgs.tar.gz
```

Note, the above command requires GNU tar. If you do not have GNU tar, a command such as:

```
zcat depkgs.tar.gz | tar xvf -
```

will probably accomplish the same thing.

3. **cd depkgs**
4. **make sqlite**

Please note that the `./configure` used to build **Bacula** will need to include `--with-sqlite` or `--with-sqlite3` depending on which version of SQLite you are using. You should not use the `--enable-batch-insert` configuration parameter for Bacula if you are using SQLite version 2 as it is probably not thread safe. If you are using SQLite version 3, you may use the `--enable-batch-insert` configuration option with Bacula, but when building SQLite3 you MUST configure it with `--enable-threadsafe` and `--enable-cross-thread-connections`.

By default, SQLite3 is now run with `PRAGMA synchronous=OFF` this increases the speed by more than 30 times, but it also increases the possibility of a corrupted database if your server crashes (power failure or kernel bug). If you want more security, you can change the PRAGMA that is used in the file `src/version.h`. At this point, you should return to completing the installation of **Bacula**.



41.2 Installing and Configuring SQLite – Phase II

This phase is done **after** you have run the `./configure` command to configure **Bacula**.

Bacula will install scripts for manipulating the database (create, delete, make tables etc) into the main installation directory. These files will be of the form `*_bacula_*` (e.g. `create_bacula_database`). These files are also available in the `<bacula-src>/src/cats` directory after running `./configure`. If you inspect `create_bacula_database`, you will see that it calls `create_sqlite_database`. The `*_bacula_*` files are provided for convenience. It doesn't matter what database you have chosen; `create_bacula_database` will always create your database.

At this point, you can create the SQLite database and tables:

1. `cd <install-directory>`

This directory contains the Bacula catalog interface routines.

2. `./make_sqlite_tables`

This script creates the SQLite database as well as the tables used by **Bacula**. This script will be automatically setup by the `./configure` program to create a database named `bacula.db` in **Bacula's** working directory.

41.3 Linking Bacula with SQLite

If you have followed the above steps, this will all happen automatically and the SQLite libraries will be linked into **Bacula**.

41.4 Testing SQLite

We have much less "production" experience using SQLite than using MySQL. SQLite has performed flawlessly for us in all our testing. However, several users have reported corrupted databases while using SQLite. For that reason, we do not recommend it for production use.

If Bacula crashes with the following type of error when it is started:

```
Using default Catalog name=MyCatalog DB=bacula
Could not open database "bacula".
sqlite.c:151 Unable to open Database=/var/lib/bacula/bacula.db.
ERR=malformed database schema - unable to open a temporary database file
for storing temporary tables
```

this is most likely caused by the fact that some versions of SQLite attempt to create a temporary file in the current directory. If that fails, because Bacula does not have write permission on the current directory, then you may get this err. The solution is to start Bacula in a current directory where it has write permission.

41.5 Re-initializing the Catalog Database

After you have done some initial testing with **Bacula**, you will probably want to re-initialize the catalog database and throw away all the test Jobs that you ran. To do so, you can do the following:

```
cd <install-directory>
./drop_sqlite_tables
./make_sqlite_tables
```

Please note that all information in the database will be lost and you will be starting from scratch. If you have written on any Volumes, you must write an end of file mark on the volume so that Bacula can reuse it. Do so with:

```
(stop Bacula or unmount the drive)
mt -f /dev/nst0 rewind
mt -f /dev/nst0 weof
```

Where you should replace `/dev/nst0` with the appropriate tape drive device name for your machine.



Chapter 42

Catalog Maintenance

Without proper setup and maintenance, your Catalog may continue to grow indefinitely as you run Jobs and backup Files, and/or it may become very inefficient and slow. How fast the size of your Catalog grows depends on the number of Jobs you run and how many files they backup. By deleting records within the database, you can make space available for the new records that will be added during the next Job. By constantly deleting old expired records (dates older than the Retention period), your database size will remain constant.

If you started with the default configuration files, they already contain reasonable defaults for a small number of machines (less than 5), so if you fall into that case, catalog maintenance will not be urgent if you have a few hundred megabytes of disk space free. Whatever the case may be, some knowledge of retention periods will be useful.

42.1 Setting Retention Periods

Bacula uses three Retention periods: the **File Retention** period, the **Job Retention** period, and the **Volume Retention** period. Of these three, the File Retention period is by far the most important in determining how large your database will become.

The **File Retention** and the **Job Retention** are specified in each Client resource as is shown below. The **Volume Retention** period is specified in the Pool resource, and the details are given in the next chapter of this manual.

File Retention = **<time-period-specification>** The File Retention record defines the length of time that Bacula will keep File records in the Catalog database. When this time period expires, and if **AutoPrune** is set to **yes**, Bacula will prune (remove) File records that are older than the specified File Retention period. The pruning will occur at the end of a backup Job for the given Client. Note that the Client database record contains a copy of the File and Job retention periods, but Bacula uses the current values found in the Director's Client resource to do the pruning.

Since File records in the database account for probably 80 percent of the size of the database, you should carefully determine exactly what File Retention period you need. Once the File records have been removed from the database, you will no longer be able to restore individual files in a Job. However, with Bacula version 1.37 and later, as long as the Job record still exists, you will be able to restore all files in the job.

Retention periods are specified in seconds, but as a convenience, there are a number of modifiers that permit easy specification in terms of minutes, hours, days, weeks, months, quarters, or years on the record. See the Configuration chapter of this manual for additional details of modifier specification.

The default File retention period is 60 days.

Job Retention = **<time-period-specification>** The Job Retention record defines the length of time that Bacula will keep Job records in the Catalog database. When this time period expires, and if **AutoPrune** is set to **yes** Bacula will prune (remove) Job records that are older than the specified Job Retention period. Note, if a Job record is selected for pruning, all associated File and JobMedia records will also be pruned regardless of the File Retention period set. As a consequence, you normally will set the File retention period to be less than the Job retention period.

As mentioned above, once the File records are removed from the database, you will no longer be able to restore individual files from the Job. However, as long as the Job record remains in the database, you



will be able to restore all the files backed up for the Job (on version 1.37 and later). As a consequence, it is generally a good idea to retain the Job records much longer than the File records.

The retention period is specified in seconds, but as a convenience, there are a number of modifiers that permit easy specification in terms of minutes, hours, days, weeks, months, quarters, or years. See the Configuration chapter of this manual for additional details of modifier specification.

The default Job Retention period is 180 days.

AutoPrune = <yes/no> If AutoPrune is set to **yes** (default), Bacula will automatically apply the File retention period and the Job retention period for the Client at the end of the Job.

If you turn this off by setting it to **no**, your Catalog will grow each time you run a Job.

42.2 Compacting Your MySQL Database

Over time, as noted above, your database will tend to grow. I've noticed that even though Bacula regularly prunes files, **MySQL** does not effectively use the space, and instead continues growing. To avoid this, from time to time, you must compact your database. Normally, large commercial database such as Oracle have commands that will compact a database to reclaim wasted file space. MySQL has the **OPTIMIZE TABLE** command that you can use, and SQLite version 2.8.4 and greater has the **VACUUM** command. We leave it to you to explore the utility of the **OPTIMIZE TABLE** command in MySQL.

All database programs have some means of writing the database out in ASCII format and then reloading it. Doing so will re-create the database from scratch producing a compacted result, so below, we show you how you can do this for MySQL, PostgreSQL and SQLite.

For a **MySQL** database, you could write the Bacula database as an ASCII file (bacula.sql) then reload it by doing the following:

```
mysqldump -f --opt bacula > bacula.sql
mysql bacula < bacula.sql
rm -f bacula.sql
```

Depending on the size of your database, this will take more or less time and a fair amount of disk space. For example, if I cd to the location of the MySQL Bacula database (typically /opt/mysql/var or something similar) and enter:

```
du bacula
```

I get **620,644** which means there are that many blocks containing 1024 bytes each or approximately 635 MB of data. After doing the **mysqldump**, I had a bacula.sql file that had **174,356** blocks, and after doing the **mysql** command to recreate the database, I ended up with a total of **210,464** blocks rather than the original **629,644**. In other words, the compressed version of the database took approximately one third of the space of the database that had been in use for about a year.

As a consequence, I suggest you monitor the size of your database and from time to time (once every six months or year), compress it.

42.3 Repairing Your MySQL Database

If you find that you are getting errors writing to your MySQL database, or Bacula hangs each time it tries to access the database, you should consider running MySQL's database check and repair routines. The program you need to run depends on the type of database indexing you are using. If you are using the default, you will probably want to use **myisamchk**. For more details on how to do this, please consult the MySQL document at: <http://www.mysql.com/doc/en/Repair.html>.

If the errors you are getting are simply SQL warnings, then you might try running dbcheck before (or possibly after) using the MySQL database repair program. It can clean up many of the orphaned record problems, and certain other inconsistencies in the Bacula database.

A typical cause of MySQL database problems is if your partition fills. In such a case, you will need to create additional space on the partition or free up some space then repair the database probably using **myisamchk**. Recently my root partition filled and the MySQL database was corrupted. Simply running **myisamchk -r** did not fix the problem. However, the following script did the trick for me:



```
#!/bin/sh
for i in *.MYD ; do
  mv $i x${i}
  t='echo $i | cut -f 1 -d '.' -'
  mysql bacula <<END_OF_DATA
set autocommit=1;
truncate table $t;
quit
END_OF_DATA
  cp x${i} ${i}
  chown mysql:mysql ${i}
  myisamchk -r ${t}
done
```

I invoked it with the following commands:

```
cd /var/lib/mysql/bacula
./repair
```

Then after ensuring that the database was correctly fixed, I did:

```
cd /var/lib/mysql/bacula
rm -f x*.MYD
```

42.4 MySQL Table is Full

If you are running into the error **The table 'File' is full ...**, it is probably because on version 4.x MySQL, the table is limited by default to a maximum size of 4 GB and you have probably run into the limit. The solution can be found at: <http://dev.mysql.com/doc/refman/5.0/en/full-table.html>

You can display the maximum length of your table with:

```
mysql bacula
SHOW TABLE STATUS FROM bacula like "File";
```

If the column labeled "Max_data.length" is around 4Gb, this is likely to be the source of your problem, and you can modify it with:

```
mysql bacula
ALTER TABLE File MAX_ROWS=281474976710656;
```

Alternatively you can modify your `/etc/my.conf` file before creating the Bacula tables, and in the `[mysqld]` section set:

```
set-variable = myisam_data_pointer_size=6
```

The above myisam data pointer size must be made before you create your Bacula tables or it will have no effect.

The row and pointer size changes should already be the default on MySQL version 5.x, so making these changes should only be necessary on MySQL 4.x depending on the size of your catalog database.

42.5 MySQL Server Has Gone Away

If you are having problems with the MySQL server disconnecting or with messages saying that your MySQL server has gone away, then please read the MySQL documentation, which can be found at:

<http://dev.mysql.com/doc/refman/5.0/en/gone-away.html>

42.6 MySQL Temporary Tables

When doing backups with large numbers of files, MySQL creates some temporary tables. When these tables are small they can be held in system memory, but as they approach some size, they spool off to disk. The default location for these temp tables is `/tmp`. Once that space fills up, Bacula daemons such as the Storage daemon doing spooling can get strange errors. E.g.

```
Fatal error: spool.c:402 Spool data read error.
Fatal error: backup.c:892 Network send error to SD. ERR=Connection reset by
peer
```



What you need to do is setup MySQL to use a different (larger) temp directory, which can be set in the `/etc/my.cnf` with these variables set:

```
tmpdir=/path/to/larger/tmpdir
bdb_tmpdir=/path/to/larger/tmpdir
```

42.7 Repairing Your PostgreSQL Database

The same considerations apply that are indicated above for MySQL. That is, consult the PostgreSQL documents for how to repair the database, and also consider using Bacula's `dbcheck` program if the conditions are reasonable for using (see above).

42.8 Database Performance Issues

There are a considerable number of ways each of the databases can be tuned to improve the performance. Going from an untuned database to one that is properly tuned can make a difference of a factor of 100 or more in the time to insert or search for records.

For each of the databases, you may get significant improvements by adding additional indexes. The comments in the Bacula `make_xxx_tables` give some indications as to what indexes may be appropriate. Please see below for specific instructions on checking indexes.

For MySQL, what is very important is to use the examine the `my.cnf` file (usually in `/etc/my.cnf`). You may obtain significant performances by switching to the `my-large.cnf` or `my-huge.cnf` files that come with the MySQL source code.

For SQLite3, one significant factor in improving the performance is to ensure that there is a "PRAGMA synchronous = NORMAL;" statement. This reduces the number of times that the database flushes the in memory cache to disk. There are other settings for this PRAGMA that can give even further performance improvements at the risk of a database corruption if your system crashes.

For PostgreSQL, you might want to consider turning `fsync` off. Of course doing so can cause corrupted databases in the event of a machine crash. There are many different ways that you can tune PostgreSQL, the following document discusses a few of them: <http://www.varlena.com/varlena/GeneralBits/Tidbits/perf.html> .

There is also a PostgreSQL FAQ question number 3.3 that may answer some of your questions about how to improve performance of the PostgreSQL engine: <http://www.postgresql.org/docs/faqs.FAQ.html#3.3> .

Also for PostgreSQL, look at what "effective_cache_size". For a 2GB memory machine, you probably want to set it at 131072, but don't set it too high. In addition, for a 2GB system, `work_mem = 256000` and `maintenance_work_mem = 256000` seem to be reasonable values. Make sure your `checkpoint_segments` is set to at least 8.

42.9 Performance Issues Indexes

One of the most important considerations for improving performance on the Bacula database is to ensure that it has all the appropriate indexes. Several users have reported finding that their database did not have all the indexes in the default configuration. In addition, you may find that because of your own usage patterns, you need additional indexes.

The most important indexes for performance are the two indexes on the **File** table. The first index is on **FileId** and is automatically made because it is the unique key used to access the table. The other one is the (JobId, PathId, Filename) index. If these Indexes are not present, your performance may suffer a lot.

42.9.1 PostgreSQL Indexes

On PostgreSQL, you can check to see if you have the proper indexes using the following commands:

```
psql bacula
select * from pg_indexes where tablename='file';
```

If you do not see output that indicates that all three indexes are created, you can create the two additional indexes using:

```
psql bacula
CREATE INDEX file_jobid_idx on file (jobid);
CREATE INDEX file_jpf_idx on file (jobid, pathid, filenameid);
```

Make sure that you doesn't have an index on File (filenameid, pathid).



42.9.2 MySQL Indexes

On MySQL, you can check if you have the proper indexes by:

```
mysql bacula
show index from File;
```

If the indexes are not present, especially the JobId index, you can create them with the following commands:

```
mysql bacula
CREATE INDEX file_jobid_idx on File (JobId);
CREATE INDEX file_jpf_idx on File (JobId, PathId, FilenameId);
```

Though normally not a problem, you should ensure that the indexes defined for Filename and Path are both set to 255 characters. Some users reported performance problems when their indexes were set to 50 characters. To check, do:

```
mysql bacula
show index from Filename;
show index from Path;
```

and what is important is that for Filename, you have an index with Key_name "Name" and Sub_part "255". For Path, you should have a Key_name "Path" and Sub_part "255". If one or the other does not exist or the Sub_part is less than 255, you can drop and recreate the appropriate index with:

```
mysql bacula
DROP INDEX Path on Path;
CREATE INDEX Path on Path (Path(255));

DROP INDEX Name on Filename;
CREATE INDEX Name on Filename (Name(255));
```

42.9.3 SQLite Indexes

On SQLite, you can check if you have the proper indexes by:

```
sqlite <path>/bacula.db
select * from sqlite_master where type='index' and tbl_name='File';
```

If the indexes are not present, especially the JobId index, you can create them with the following commands:

```
sqlite <path>/bacula.db
CREATE INDEX file_jobid_idx on File (JobId);
CREATE INDEX file_jfp_idx on File (JobId, PathId, FilenameId);
```

42.10 Compacting Your PostgreSQL Database

Over time, as noted above, your database will tend to grow. I've noticed that even though Bacula regularly prunes files, PostgreSQL has a **VACUUM** command that will compact your database for you. Alternatively you may want to use the **vacuumdb** command, which can be run from a cron job.

All database programs have some means of writing the database out in ASCII format and then reloading it. Doing so will re-create the database from scratch producing a compacted result, so below, we show you how you can do this for PostgreSQL.

For a **PostgreSQL** database, you could write the Bacula database as an ASCII file (bacula.sql) then reload it by doing the following:

```
pg_dump -c bacula > bacula.sql
cat bacula.sql | psql bacula
rm -f bacula.sql
```

Depending on the size of your database, this will take more or less time and a fair amount of disk space. For example, you can **cd** to the location of the Bacula database (typically /usr/local/pgsql/data or possible /var/lib/pgsql/data) and check the size.

There are certain PostgreSQL users who do not recommend the above procedure. They have the following to say: PostgreSQL does not need to be dumped/restored to keep the database efficient. A normal process of vacuuming will prevent the database from every getting too large. If you want to fine-tweak the database storage, commands such as **VACUUM FULL**, **REINDEX**, and **CLUSTER** exist specifically to keep you from having to do a dump/restore.

Finally, you might want to look at the PostgreSQL documentation on this subject at <http://www.postgresql.org/docs/8.1/interactive/maintenance.html>.



42.11 Compacting Your SQLite Database

First please read the previous section that explains why it is necessary to compress a database. SQLite version 2.8.4 and greater have the **Vacuum** command for compacting the database.

```
cd {\bf working-directory}
echo 'vacuum;' | sqlite bacula.db
```

As an alternative, you can use the following commands, adapted to your system:

```
cd {\bf working-directory}
echo '.dump' | sqlite bacula.db > bacula.sql
rm -f bacula.db
sqlite bacula.db < bacula.sql
rm -f bacula.sql
```

Where **working-directory** is the directory that you specified in the Director's configuration file. Note, in the case of SQLite, it is necessary to completely delete (rm) the old database before creating a new compressed version.

42.12 Migrating from SQLite to MySQL or PostgreSQL

You may begin using Bacula with SQLite then later find that you want to switch to MySQL or Postgres for any of a number of reasons: SQLite tends to use more disk than MySQL; when the database is corrupted it is often more catastrophic than with MySQL or PostgreSQL. Several users have succeeded in converting by exporting the SQLite data and then processing it with Perl scripts prior to putting it into MySQL or PostgreSQL. This is, however, not a simple process. Scripts are available on bacula source distribution under `examples/database`.

42.13 Backing Up Your Bacula Database

If ever the machine on which your Bacula database crashes, and you need to restore from backup tapes, one of your first priorities will probably be to recover the database. Although Bacula will happily backup your catalog database if it is specified in the FileSet, this is not a very good way to do it, because the database will be saved while Bacula is modifying it. Thus the database may be in an instable state. Worse yet, you will backup the database before all the Bacula updates have been applied.

To resolve these problems, you need to backup the database after all the backup jobs have been run. In addition, you will want to make a copy while Bacula is not modifying it. To do so, you can use two scripts provided in the release **make_catalog_backup** and **delete_catalog_backup**. These files will be automatically generated along with all the other Bacula scripts. The first script will make an ASCII copy of your Bacula database into **bacula.sql** in the working directory you specified in your configuration, and the second will delete the **bacula.sql** file.

The basic sequence of events to make this work correctly is as follows:

- Run all your nightly backups
- After running your nightly backups, run a Catalog backup Job
- The Catalog backup job must be scheduled after your last nightly backup
- You use **RunBeforeJob** to create the ASCII backup file and **RunAfterJob** to clean up

Assuming that you start all your nightly backup jobs at 1:05 am (and that they run one after another), you can do the catalog backup with the following additional Director configuration statements:

```
# Backup the catalog database (after the nightly save)
Job {
  Name = "BackupCatalog"
  Type = Backup
  Client=rufus-fd
  FileSet="Catalog"
  Schedule = "WeeklyCycleAfterBackup"
  Storage = DLTDive
  Messages = Standard
  Pool = Default
```



```
# WARNING!!! Passing the password via the command line is insecure.
# see comments in make_catalog_backup for details.
RunBeforeJob = "/home/kern/bacula/bin/make_catalog_backup"
RunAfterJob  = "/home/kern/bacula/bin/delete_catalog_backup"
Write Bootstrap = "/home/kern/bacula/working/BackupCatalog.bsr"
}
# This schedule does the catalog. It starts after the WeeklyCycle
Schedule {
  Name = "WeeklyCycleAfterBackup"
  Run = Level=Full sun-sat at 1:10
}
# This is the backup of the catalog
FileSet {
  Name = "Catalog"
  Include {
    Options {
      signature=MD5
    }
    File = \lt{}working_directory\gt{}/bacula.sql
  }
}
}
```

Be sure to write a bootstrap file as in the above example. However, it is preferable to write or copy the bootstrap file to another computer. It will allow you to quickly recover the database backup should that be necessary. If you do not have a bootstrap file, it is still possible to recover your database backup, but it will be more work and take longer.

42.14 Security considerations

We provide `make_catalog_backup` as an example of what can be used to backup your Bacula database. We expect you to take security precautions relevant to your situation. `make_catalog_backup` is designed to take a password on the command line. This is fine on machines with only trusted users. It is not acceptable on machines without trusted users. Most database systems provide an alternative method, which does not place the password on the command line.

The `make_catalog_backup` script contains some warnings about how to use it. Please read those tips.

To help you get started, we know PostgreSQL has a password file, `.pgpass`, and we know MySQL has `.my.cnf`.

Only you can decide what is appropriate for your situation. We have provided you with a starting point. We hope it helps.

42.15 Backing Up Third Party Databases

If you are running a database in production mode on your machine, Bacula will happily backup the files, but if the database is in use while Bacula is reading it, you may back it up in an unstable state.

The best solution is to shutdown your database before backing it up, or use some tool specific to your database to make a valid live copy perhaps by dumping the database in ASCII format. I am not a database expert, so I cannot provide you advice on how to do this, but if you are unsure about how to backup your database, you might try visiting the Backup Central site, which has been renamed Storage Mountain (www.backupcentral.com). In particular, their [Free Backup and RecoverySoftware](#) page has links to scripts that show you how to shutdown and backup most major databases.

42.16 Database Size

As mentioned above, if you do not do automatic pruning, your Catalog will grow each time you run a Job. Normally, you should decide how long you want File records to be maintained in the Catalog and set the **File Retention** period to that time. Then you can either wait and see how big your Catalog gets or make a calculation assuming approximately 154 bytes for each File saved and knowing the number of Files that are saved during each backup and the number of Clients you backup.

For example, suppose you do a backup of two systems, each with 100,000 files. Suppose further that you do a Full backup weekly and an Incremental every day, and that the Incremental backup typically saves 4,000 files. The size of your database after a month can roughly be calculated as:

$$\text{Size} = 154 * \text{No. Systems} * (100,000 * 4 + 10,000 * 26)$$



where we have assumed four weeks in a month and 26 incremental backups per month. This would give the following:

```

Size = 154 * 2 * (100,000 * 4 + 10,000 * 26)
or
Size = 308 * (400,000 + 260,000)
or
Size = 203,280,000 bytes

```

So for the above two systems, we should expect to have a database size of approximately 200 Megabytes. Of course, this will vary according to how many files are actually backed up.

Below are some statistics for a MySQL database containing Job records for five Clients beginning September 2001 through May 2002 (8.5 months) and File records for the last 80 days. (Older File records have been pruned). For these systems, only the user files and system files that change are backed up. The core part of the system is assumed to be easily reloaded from the Red Hat rpms.

In the list below, the files (corresponding to Bacula Tables) with the extension .MYD contain the data records whereas files with the extension .MYI contain indexes.

You will note that the File records (containing the file attributes) make up the large bulk of the number of records as well as the space used (459 Mega Bytes including the indexes). As a consequence, the most important Retention period will be the **File Retention** period. A quick calculation shows that for each File that is saved, the database grows by approximately 150 bytes.

Size in Bytes	Records	File
=====	=====	=====
168	5	Client.MYD
3,072		Client.MYI
344,394,684	3,080,191	File.MYD
115,280,896		File.MYI
2,590,316	106,902	Filename.MYD
3,026,944		Filename.MYI
184	4	FileSet.MYD
2,048		FileSet.MYI
49,062	1,326	JobMedia.MYD
30,720		JobMedia.MYI
141,752	1,378	Job.MYD
13,312		Job.MYI
1,004	11	Media.MYD
3,072		Media.MYI
1,299,512	22,233	Path.MYD
581,632		Path.MYI
36	1	Pool.MYD
3,072		Pool.MYI
5	1	Version.MYD
1,024		Version.MYI

This database has a total size of approximately 450 Megabytes.

If we were using SQLite, the determination of the total database size would be much easier since it is a single file, but we would have less insight to the size of the individual tables as we have in this case.

Note, SQLite databases may be as much as 50% larger than MySQL databases due to the fact that all data is stored as ASCII strings. That is even binary integers are stored as ASCII strings, and this seems to increase the space needed.



Chapter 43

Bacula Security Issues

- Security means being able to restore your files, so read the Critical Items Chapter of this manual.
- The Clients (**bacula-fd**) must run as root to be able to access all the system files.
- It is not necessary to run the Director as root.
- It is not necessary to run the Storage daemon as root, but you must ensure that it can open the tape drives, which are often restricted to root access by default. In addition, if you do not run the Storage daemon as root, it will not be able to automatically set your tape drive parameters on most OSes since these functions, unfortunately require root access.
- You should restrict access to the Bacula configuration files, so that the passwords are not world-readable. The **Bacula** daemons are password protected using CRAM-MD5 (i.e. the password is not sent across the network). This will ensure that not everyone can access the daemons. It is a reasonably good protection, but can be cracked by experts.
- If you are using the recommended ports 9101, 9102, and 9103, you will probably want to protect these ports from external access using a firewall and/or using tcp wrappers (**etc/hosts.allow**).
- By default, all data that is sent across the network is unencrypted. However, Bacula does support TLS (transport layer security) and can encrypt transmitted data. Please read the TLS (SSL) Communications Encryption section of this manual.
- You should ensure that the Bacula working directories are readable and writable only by the Bacula daemons.
- If you are using **MySQL** it is not necessary for it to run with **root** permission.
- The default Bacula **grant-mysql-permissions** script grants all permissions to use the MySQL database without a password. If you want security, please tighten this up!
- Don't forget that Bacula is a network program, so anyone anywhere on the network with the console program and the Director's password can access Bacula and the backed up data.
- You can restrict what IP addresses Bacula will bind to by using the appropriate **DirAddress**, **FDAddress**, or **SDAddress** records in the respective daemon configuration files.
- Be aware that if you are backing up your database using the default script, if you have a password on your database, it will be passed as a command line option to that script, and any user will be able to see this information. If you want it to be secure, you will need to pass it by an environment variable or a secure file.

See also Backing Up Your Bacula Database - Security Considerations for more information.

43.1 Backward Compatibility

One of the major goals of Bacula is to ensure that you can restore tapes (I'll use the word tape to include disk Volumes) that you wrote years ago. This means that each new version of Bacula should be able to read old format tapes. The first problem you will have is to ensure that the hardware is still working some years down the road, and the second problem will be to ensure that the media will still be good, then your OS



must be able to interface to the device, and finally Bacula must be able to recognize old formats. All the problems except the last are ones that we cannot solve, but by careful planning you can.

Since the very beginning of Bacula (January 2000) until today (December 2005), there have been two major Bacula tape formats. The second format was introduced in version 1.27 in November of 2002, and it has not changed since then. In principle, Bacula can still read the original format, but I haven't tried it lately so who knows ...

Though the tape format is fixed, the kinds of data that we can put on the tapes are extensible, and that is how we added new features such as ACLs, Win32 data, encrypted data, ... Obviously, an older version of Bacula would not know how to read these newer data streams, but each newer version of Bacula should know how to read all the older streams.

If you want to be 100% should:

1. Try reading old tapes from time to time – e.g. at least once a year.
2. Keep statically linked copies of every version of Bacula that you use in production then if for some reason, we botch up old tape compatibility, you can always pull out an old copy of Bacula ...

The second point is probably overkill but if you want to be sure, it may save you someday.

43.2 Configuring and Testing TCP Wrappers

TCP Wrappers are implemented if you turn them on when configuring (`./configure --with-tcp-wrappers`). With this code enabled, you may control who may access your daemons. This control is done by modifying the file: `/etc/hosts.allow`. The program name that **Bacula** uses when applying these access restrictions is the name you specify in the daemon configuration file (see below for examples). You must not use the **twist** option in your `/etc/hosts.allow` or it will terminate the Bacula daemon when a connection is refused.

The exact name of the package you need loaded to build with TCP wrappers depends on the system. For example, on SuSE, the TCP wrappers libraries needed to link Bacula are contained in the `tcpd-devel` package. On Red Hat, the package is named `tcp-wrappers`.

Dan Langille has provided the following information on configuring and testing TCP wrappers with Bacula. If you read `hosts_options(5)`, you will see an option called `twist`. This option replaces the current process by an instance of the specified shell command. Typically, something like this is used:

```
ALL : ALL \
: severity auth.info \
: twist /bin/echo "You are not welcome to use %d from %h."
```

The `libwrap` code tries to avoid **twist** if it runs in a resident process, but that test will not protect the first `hosts_access()` call. This will result in the process (e.g. `bacula-fd`, `bacula-sd`, `bacula-dir`) being terminated if the first connection to their port results in the `twist` option being invoked. The potential, and I stress potential, exists for an attacker to prevent the daemons from running. This situation is eliminated if your `/etc/hosts.allow` file contains an appropriate rule set. The following example is sufficient:

```
undef-fd : localhost : allow
undef-sd : localhost : allow
undef-dir : localhost : allow
undef-fd : ALL : deny
undef-sd : ALL : deny
undef-dir : ALL : deny
```

You must adjust the names to be the same as the Name directives found in each of the daemon configuration files. They are, in general, not the same as the binary daemon names. It is not possible to use the daemon names because multiple daemons may be running on the same machine but with different configurations.

In these examples, the Director is `undef-dir`, the Storage Daemon is `undef-sd`, and the File Daemon is `undef-fd`. Adjust to suit your situation. The above example rules assume that the SD, FD, and DIR all reside on the same box. If you have a remote FD client, then the following rule set on the remote client will suffice:

```
undef-fd : director.example.org : allow
undef-fd : ALL : deny
```

where `director.example.org` is the host which will be contacting the client (ie. the box on which the Bacula Director daemon runs). The use of "ALL : deny" ensures that the `twist` option (if present) is not invoked. To properly test your configuration, start the daemon(s), then attempt to connect from an IP address which should be able to connect. You should see something like this:



```
$ telnet undef 9103
Trying 192.168.0.56...
Connected to undef.example.org.
Escape character is '^]'.
Connection closed by foreign host.
$
```

This is the correct response. If you see this:

```
$ telnet undef 9103
Trying 192.168.0.56...
Connected to undef.example.org.
Escape character is '^]'.
You are not welcome to use undef-sd from xeon.example.org.
Connection closed by foreign host.
$
```

then `twist` has been invoked and your configuration is not correct and you need to add the deny statement. It is important to note that your testing must include restarting the daemons after each connection attempt. You can also `tcpdchk(8)` and `tcpdmatch(8)` to validate your `/etc/hosts.allow` rules. Here is a simple test using `tcpdmatch`:

```
$ tcpdmatch undef-dir xeon.example.org
warning: undef-dir: no such process name in /etc/inetd.conf
client: hostname xeon.example.org
client: address 192.168.0.18
server: process undef-dir
matched: /etc/hosts.allow line 40
option: allow
access: granted
```

If you are running Bacula as a standalone daemon, the warning above can be safely ignored. Here is an example which indicates that your rules are missing a deny statement and the `twist` option has been invoked.

```
$ tcpdmatch undef-dir 10.0.0.1
warning: undef-dir: no such process name in /etc/inetd.conf
client: address 10.0.0.1
server: process undef-dir
matched: /etc/hosts.allow line 91
option: severity auth.info
option: twist /bin/echo "You are not welcome to use
undef-dir from 10.0.0.1."
access: delegated
```

43.3 Running as non-root

Security advice from Dan Langille:

It is a good idea to run daemons with the lowest possible privileges. In other words, if you can, don't run applications as root which do not have to be root. The Storage Daemon and the Director Daemon do not need to be root. The File Daemon needs to be root in order to access all files on your system. In order to run as non-root, you need to create a user and a group. Choosing `bacula` as both the user name and the group name sounds like a good idea to me.

The FreeBSD port creates this user and group for you. Here is what those entries looked like on my FreeBSD laptop:

```
bacula:*:1002:1002::0:0:Bacula Daemon:/var/db/bacula:/sbin/nologin
```

I used `vipw` to create this entry. I selected a User ID and Group ID of 1002 as they were unused on my system.

I also created a group in `/etc/group`:

```
bacula:*:1002:
```

The `bacula` user (as opposed to the Bacula daemon) will have a home directory of `/var/db/bacula` which is the default location for the Bacula database.

Now that you have both a `bacula` user and a `bacula` group, you can secure the `bacula` home directory by issuing this command:

```
chown -R bacula:bacula /var/db/bacula/
```



This ensures that only the bacula user can access this directory. It also means that if we run the Director and the Storage daemon as bacula, those daemons also have restricted access. This would not be the case if they were running as root.

It is important to note that the storage daemon actually needs to be in the operator group for normal access to tape drives etc (at least on a FreeBSD system, that's how things are set up by default) Such devices are normally chown root:operator. It is easier and less error prone to make Bacula a member of that group than it is to play around with system permissions.

Starting the Bacula daemons

To start the bacula daemons on a FreeBSD system, issue the following command:

```
/usr/local/etc/rc.d/bacula-dir start
/usr/local/etc/rc.d/bacula-sd start
/usr/local/etc/rc.d/bacula-fd start
```

To confirm they are all running:

```
$ ps auxx | grep bacula
root  63418  0.0  0.3 1856 1036 ?? Ss  4:09PM  0:00.00
        /usr/local/sbin/bacula-fd -v -c /usr/local/etc/bacula-fd.conf
bacula 63416  0.0  0.3 2040 1172 ?? Ss  4:09PM  0:00.01
        /usr/local/sbin/bacula-sd -v -c /usr/local/etc/bacula-sd.conf
bacula 63422  0.0  0.4 2360 1440 ?? Ss  4:09PM  0:00.00
        /usr/local/sbin/bacula-dir -v -c /usr/local/etc/bacula-dir.conf
```



Chapter 44

The Bootstrap File

The information in this chapter is provided so that you may either create your own bootstrap files, or so that you can edit a bootstrap file produced by **Bacula**. However, normally the bootstrap file will be automatically created for you during the **Bacula Console** chapter (chapter 1 on page 1) of the Bacula Community Console Manual, or by using a Write Bootstrap record in your Backup Jobs, and thus you will never need to know the details of this file.

The **bootstrap** file contains ASCII information that permits precise specification of what files should be restored, what volume they are on, and where they are on the volume. It is a relatively compact form of specifying the information, is human readable, and can be edited with any text editor.

44.1 Bootstrap File Format

The general format of a **bootstrap** file is:

<keyword>= <value>

Where each **keyword** and the **value** specify which files to restore. More precisely the **keyword** and their **values** serve to limit which files will be restored and thus act as a filter. The absence of a keyword means that all records will be accepted.

Blank lines and lines beginning with a pound sign (#) in the bootstrap file are ignored.

There are keywords which permit filtering by Volume, Client, Job, FileIndex, Session Id, Session Time, ...

The more keywords that are specified, the more selective the specification of which files to restore will be.

In fact, each keyword is **ANDed** with other keywords that may be present.

For example,

```
Volume = Test-001
VolSessionId = 1
VolSessionTime = 108927638
```

directs the Storage daemon (or the **bextract** program) to restore only those files on Volume Test-001 **AND** having VolumeSessionId equal to one **AND** having VolumeSession time equal to 108927638.

The full set of permitted keywords presented in the order in which they are matched against the Volume records are:

Volume The value field specifies what Volume the following commands apply to. Each Volume specification becomes the current Volume, to which all the following commands apply until a new current Volume (if any) is specified. If the Volume name contains spaces, it should be enclosed in quotes. At least one Volume specification is required.

Count The value is the total number of files that will be restored for this Volume. This allows the Storage daemon to know when to stop reading the Volume. This value is optional.

VolFile The value is a file number, a list of file numbers, or a range of file numbers to match on the current Volume. The file number represents the physical file on the Volume where the data is stored. For a tape volume, this record is used to position to the correct starting file, and once the tape is past the last specified file, reading will stop.

VolBlock The value is a block number, a list of block numbers, or a range of block numbers to match on the current Volume. The block number represents the physical block within the file on the Volume where the data is stored.



VolSessionTime The value specifies a Volume Session Time to be matched from the current volume.

VolSessionId The value specifies a VolSessionId, a list of volume session ids, or a range of volume session ids to be matched from the current Volume. Each VolSessionId and VolSessionTime pair corresponds to a unique Job that is backed up on the Volume.

JobId The value specifies a JobId, list of JobIds, or range of JobIds to be selected from the current Volume. Note, the JobId may not be unique if you have multiple Directors, or if you have reinitialized your database. The JobId filter works only if you do not run multiple simultaneous jobs. This value is optional and not used by Bacula to restore files.

Job The value specifies a Job name or list of Job names to be matched on the current Volume. The Job corresponds to a unique VolSessionId and VolSessionTime pair. However, the Job is perhaps a bit more readable by humans. Standard regular expressions (wildcards) may be used to match Job names. The Job filter works only if you do not run multiple simultaneous jobs. This value is optional and not used by Bacula to restore files.

Client The value specifies a Client name or list of Clients to will be matched on the current Volume. Standard regular expressions (wildcards) may be used to match Client names. The Client filter works only if you do not run multiple simultaneous jobs. This value is optional and not used by Bacula to restore files.

FileIndex The value specifies a FileIndex, list of FileIndexes, or range of FileIndexes to be selected from the current Volume. Each file (data) stored on a Volume within a Session has a unique FileIndex. For each Session, the first file written is assigned FileIndex equal to one and incremented for each file backed up.

This for a given Volume, the triple VolSessionId, VolSessionTime, and FileIndex uniquely identifies a file stored on the Volume. Multiple copies of the same file may be stored on the same Volume, but for each file, the triple VolSessionId, VolSessionTime, and FileIndex will be unique. This triple is stored in the Catalog database for each file.

To restore a particular file, this value (or a range of FileIndexes) is required.

FileRegex The value is a regular expression. When specified, only matching filenames will be restored.

```
FileRegex=~etc/passwd(.old)?
```

Slot The value specifies the autochanger slot. There may be only a single **Slot** specification for each Volume.

Stream The value specifies a Stream, a list of Streams, or a range of Streams to be selected from the current Volume. Unless you really know what you are doing (the internals of **Bacula**), you should avoid this specification. This value is optional and not used by Bacula to restore files.

***JobType** Not yet implemented.

***JobLevel** Not yet implemented.

The **Volume** record is a bit special in that it must be the first record. The other keyword records may appear in any order and any number following a Volume record.

Multiple Volume records may be specified in the same bootstrap file, but each one starts a new set of filter criteria for the Volume.

In processing the bootstrap file within the current Volume, each filter specified by a keyword is **AND**ed with the next. Thus,

```
Volume = Test-01
Client = "My machine"
FileIndex = 1
```

will match records on Volume **Test-01 AND** Client records for **My machine AND** FileIndex equal to **one**.

Multiple occurrences of the same record are **OR**ed together. Thus,

```
Volume = Test-01
Client = "My machine"
Client = "Backup machine"
FileIndex = 1
```



will match records on Volume **Test-01 AND** (Client records for **My machine OR Backup machine**) **AND** FileIndex equal to **one**.

For integer values, you may supply a range or a list, and for all other values except Volumes, you may specify a list. A list is equivalent to multiple records of the same keyword. For example,

```
Volume = Test-01
Client = "My machine", "Backup machine"
FileIndex = 1-20, 35
```

will match records on Volume **Test-01 AND** (Client records for **My machine OR Backup machine**) **AND** (FileIndex **1 OR 2 OR 3 ... OR 20 OR 35**).

As previously mentioned above, there may be multiple Volume records in the same bootstrap file. Each new Volume definition begins a new set of filter conditions that apply to that Volume and will be **ORed** with any other Volume definitions.

As an example, suppose we query for the current set of tapes to restore all files on Client **Rufus** using the **query** command in the console program:

```
Using default Catalog name=MySQL DB=bacula
*query
Available queries:
  1: List Job totals:
  2: List where a file is saved:
  3: List where the most recent copies of a file are saved:
  4: List total files/bytes by Job:
  5: List total files/bytes by Volume:
  6: List last 10 Full Backups for a Client:
  7: List Volumes used by selected JobId:
  8: List Volumes to Restore All Files:
Choose a query (1-8): 8
Enter Client Name: Rufus
+-----+-----+-----+-----+-----+-----+
| JobId | StartTime          | VolumeName | StartFile | VolSesId | VolSesTime |
+-----+-----+-----+-----+-----+-----+
| 154   | 2002-05-30 12:08 | test-02   | 0         | 1        | 1022753312 |
| 202   | 2002-06-15 10:16 | test-02   | 0         | 2        | 1024128917 |
| 203   | 2002-06-15 11:12 | test-02   | 3         | 1        | 1024132350 |
| 204   | 2002-06-18 08:11 | test-02   | 4         | 1        | 1024380678 |
+-----+-----+-----+-----+-----+-----+
```

The output shows us that there are four Jobs that must be restored. The first one is a Full backup, and the following three are all Incremental backups.

The following bootstrap file will restore those files:

```
Volume=test-02
VolSessionId=1
VolSessionTime=1022753312
Volume=test-02
VolSessionId=2
VolSessionTime=1024128917
Volume=test-02
VolSessionId=1
VolSessionTime=1024132350
Volume=test-02
VolSessionId=1
VolSessionTime=1024380678
```

As a final example, assume that the initial Full save spanned two Volumes. The output from **query** might look like:

```
+-----+-----+-----+-----+-----+-----+
| JobId | StartTime          | VolumeName | StartFile | VolSesId | VolSesTime |
+-----+-----+-----+-----+-----+-----+
| 242   | 2002-06-25 16:50 | File0003  | 0         | 1        | 1025016612 |
| 242   | 2002-06-25 16:50 | File0004  | 0         | 1        | 1025016612 |
| 243   | 2002-06-25 16:52 | File0005  | 0         | 2        | 1025016612 |
| 246   | 2002-06-25 19:19 | File0006  | 0         | 2        | 1025025494 |
+-----+-----+-----+-----+-----+-----+
```

and the following bootstrap file would restore those files:



```
Volume=File0003
VolSessionId=1
VolSessionTime=1025016612
Volume=File0004
VolSessionId=1
VolSessionTime=1025016612
Volume=File0005
VolSessionId=2
VolSessionTime=1025016612
Volume=File0006
VolSessionId=2
VolSessionTime=1025025494
```

44.2 Automatic Generation of Bootstrap Files

One thing that is probably worth knowing: the bootstrap files that are generated automatically at the end of the job are not as optimized as those generated by the restore command. This is because during Incremental and Differential jobs, the records pertaining to the files written for the Job are appended to the end of the bootstrap file. As consequence, all the files saved to an Incremental or Differential job will be restored first by the Full save, then by any Incremental or Differential saves.

When the bootstrap file is generated for the restore command, only one copy (the most recent) of each file is restored.

So if you have spare cycles on your machine, you could optimize the bootstrap files by doing the following:

```
./bconsole
restore client=xxx select all
done
no
quit
Backup bootstrap file.
```

The above will not work if you have multiple FileSets because that will be an extra prompt. However, the **restore client=xxx select all** builds the in-memory tree, selecting everything and creates the bootstrap file.

The **no** answers the **Do you want to run this (yes/mod/no)** question.

44.3 Bootstrap for bscan

If you have a very large number of Volumes to scan with **bscan**, you may exceed the command line limit (511 characters). In that case, you can create a simple bootstrap file that consists of only the volume names. An example might be:

```
Volume="Vol1001"
Volume="Vol1002"
Volume="Vol1003"
Volume="Vol1004"
Volume="Vol1005"
```

44.4 A Final Bootstrap Example

If you want to extract or copy a single Job, you can do it by selecting by JobId (code not tested) or better yet, if you know the VolSessionTime and the VolSessionId (printed on Job report and in Catalog), specifying this is by far the best. Using the VolSessionTime and VolSessionId is the way Bacula does restores. A bsr file might look like the following:

```
Volume="Vol1001"
VolSessionId=10
VolSessionTime=1080847820
```

If you know how many files are backed up (on the job report), you can enormously speed up the selection by adding (let's assume there are 157 files):

```
FileIndex=1-157
Count=157
```



Finally, if you know the File number where the Job starts, you can also cause bcopy to forward space to the right file without reading every record:

```
VolFile=20
```

There is nothing magic or complicated about a BSR file. Parsing it and properly applying it within Bacula **is** magic, but you don't need to worry about that.

If you want to see a **real** bsr file, simply fire up the **restore** command in the console program, select something, then answer no when it prompts to run the job. Then look at the file **restore.bsr** in your working directory.





Chapter 45

Bacula Copyright, Trademark, and Licenses

There are a number of different licenses that are used in Bacula. If you have a printed copy of this manual, the details of each of the licenses referred to in this chapter can be found in the online version of the manual at <http://www.bacula.org> .

45.1 CC-BY-SA

The Creative Commons Attribution-ShareAlike 4.0 International License (CC-BY-SA) is used for this manual, which is a free and open license. Though there are certain restrictions that come with this license you may in general freely reproduce it and even make changes to it. However, rather than distribute your own version of this manual, we would much prefer if you would send any corrections or changes to the Bacula project.

The most recent version of the manual can always be found online at <http://www.bacula.org> .

45.2 GPL

The vast bulk of the source code is released under the Affero GNU General Public License version 3.. Most of this code is copyrighted: Copyright ©2000-2014 Free Software Foundation Europe e.V. Portions may be copyrighted by other people. These files are released under different licenses which are compatible with the Bacula AGPLv3 license.

45.3 LGPL

Some of the Bacula library source code is released under the GNU Lesser General Public License. This permits third parties to use these parts of our code in their proprietary programs to interface to Bacula.

45.4 Public Domain

Some of the Bacula code, or code that Bacula references, has been released to the public domain. E.g. md5.c, SQLite.

45.5 Trademark

Bacula[®] is a registered trademark of Kern Sibbald.

45.6 Fiduciary License Agreement

Developers who have contributed significant changes to the Bacula code should have signed a Fiduciary License Agreement (FLA), which guarantees them the right to use the code they have developed, and also



ensures that the Free Software Foundation Europe (and thus the Bacula project) has the rights to the code. This Fiduciary License Agreement is found on the Bacula web site at: <http://www.bacula.org/en/FLA-bacula.en.pdf> and if you are submitting code, you should fill it out then sent to:

Kern Sibbald
Cotes-de-Montmoiret 9
1012 Lausanne
Switzerland

When you send in such a complete document, please notify me: kern at sibbald dot com.

45.7 Disclaimer

NO WARRANTY

BECAUSE THE PROGRAM IS LICENSED FREE OF CHARGE, THERE IS NO WARRANTY FOR THE PROGRAM, TO THE EXTENT PERMITTED BY APPLICABLE LAW. EXCEPT WHEN OTHERWISE STATED IN WRITING THE COPYRIGHT HOLDERS AND/OR OTHER PARTIES PROVIDE THE PROGRAM "AS IS" WITHOUT WARRANTY OF ANY KIND, EITHER EXPRESSED OR IMPLIED, INCLUDING, BUT NOT LIMITED TO, THE IMPLIED WARRANTIES OF MERCHANTABILITY AND FITNESS FOR A PARTICULAR PURPOSE. THE ENTIRE RISK AS TO THE QUALITY AND PERFORMANCE OF THE PROGRAM IS WITH YOU. SHOULD THE PROGRAM PROVE DEFECTIVE, YOU ASSUME THE COST OF ALL NECESSARY SERVICING, REPAIR OR CORRECTION. IN NO EVENT UNLESS REQUIRED BY APPLICABLE LAW OR AGREED TO IN WRITING WILL ANY COPYRIGHT HOLDER, OR ANY OTHER PARTY WHO MAY MODIFY AND/OR REDISTRIBUTE THE PROGRAM AS PERMITTED ABOVE, BE LIABLE TO YOU FOR DAMAGES, INCLUDING ANY GENERAL, SPECIAL, INCIDENTAL OR CONSEQUENTIAL DAMAGES ARISING OUT OF THE USE OR INABILITY TO USE THE PROGRAM (INCLUDING BUT NOT LIMITED TO LOSS OF DATA OR DATA BEING RENDERED INACCURATE OR LOSSES SUSTAINED BY YOU OR THIRD PARTIES OR A FAILURE OF THE PROGRAM TO OPERATE WITH ANY OTHER PROGRAMS), EVEN IF SUCH HOLDER OR OTHER PARTY HAS BEEN ADVISED OF THE POSSIBILITY OF SUCH DAMAGES.

45.8 Authors

The following people below have contributed to making this document what it is today:

Alexandre Baron `jbalexfr` at `users dot sourceforge dot net`; Arno Lehmann `jarnol` at `users dot sourceforge dot net`; Bastian Friedrich `jbastian dot friedrich` at `collax dot com`; Christopher S Hull `jcsh` at `raid solutions dot com`; Dan Langille Davide Franco `jdfranco` at `dflc dot ch`; Dirk H Bartley `jdbartley` at `schupan dot com`; Eric Bollengier `jeric.bollengier` at `baculasystems dot com`; Frank Sweetser James Harper `bendigoit dot com dot au`; Jeremy C Reed `jjeremy-c-reed` at `users dot sourceforge dot net`; Jose Herrera `jherrera.js` at `yahoo dot com`; Jo Simoens Juan Luis Francis `jindpnday` at `users dot sourceforge dot net`; Karl Cunningham `karlec` at `users dot sourceforge dot net`; Kern Sibbald `jkern` at `sibbald dot com`; Landon Fuller `jlandonf` at `opendarwin dot org`; Lucas Di Pentima Ludovic Strappazon Meno Abels Mikael Kermorgant `jmikael dot kermorgant` at `gmail dot com`; Nicolas Boichat Peter Buschman Philippe Chauvat `jphilippe dot chauvat` at `baculasystems dot com`; Philipp Storz Richard Mortimer `jrichm` at `oldelvet dot org dot uk`; Robert Nelson `jrobertn` at `the-nelsons dot org`; Scott Barninger Sebastien Guilbaud Thomas Glatthor Thomas Mueller `jthomas` at `chaschperli dot ch`; Thorsten Engel `jthorsten dot engel` at `matrix-computer dot com`; Victor Hugo dos Santos `jvictorhugops` at `users dot sourceforge dot net`



Creative Commons Attribution-ShareAlike 4.0 International

Attribution-ShareAlike 4.0 International

Creative Commons Corporation (Creative Commons) is not a law firm and does not provide legal services.

Using Creative Commons Public Licenses

Creative Commons public licenses provide a standard set of terms and conditions that creators and other

Considerations for licensors: Our public licenses are intended for use by those authorized to grant

Considerations for the public: By using one of our public licenses, a licensor grants the public

Creative Commons Attribution-ShareAlike 4.0 International Public License

By exercising the Licensed Rights (defined below), You accept and agree to be bound by the terms and

Section 1 Definitions.

Adapted Material means material subject to Copyright and Similar Rights that is derived from or

Adapter's License means the license You apply to Your Copyright and Similar Rights in Your contr

BY-SA Compatible License means a license listed at creativecommons.org/compatiblelicenses, appro

Copyright and Similar Rights means copyright and/or similar rights closely related to copyright

Effective Technological Measures means those measures that, in the absence of proper authority, ,

Exceptions and Limitations means fair use, fair dealing, and/or any other exception or limitatio

License Elements means the license attributes listed in the name of a Creative Commons Public Li

Licensed Material means the artistic or literary work, database, or other material to which the

Licensed Rights means the rights granted to You subject to the terms and conditions of this Publ

Licensor means the individual(s) or entity(ies) granting rights under this Public License.

Share means to provide material to the public by any means or process that requires permission u

Sui Generis Database Rights means rights other than copyright resulting from Directive 96/9/EC o

You means the individual or entity exercising the Licensed Rights under this Public License. You

Section 2 Scope.

License grant.

Subject to the terms and conditions of this Public License, the Licensor hereby grants You a

reproduce and Share the Licensed Material, in whole or in part; and

produce, reproduce, and Share Adapted Material.

Exceptions and Limitations. For the avoidance of doubt, where Exceptions and Limitations app

Term. The term of this Public License is specified in Section 6(a).

Media and formats; technical modifications allowed. The Licensor authorizes You to exercise

Downstream recipients.

Offer from the Licensor Licensed Material. Every recipient of the Licensed Material aut

Additional offer from the Licensor Adapted Material. Every recipient of Adapted Materia

No downstream restrictions. You may not offer or impose any additional or different term

No endorsement. Nothing in this Public License constitutes or may be construed as permission

Other rights.

Moral rights, such as the right of integrity, are not licensed under this Public License, no

Patent and trademark rights are not licensed under this Public License.

To the extent possible, the Licensor waives any right to collect royalties from You for the

Section 3 License Conditions.

Your exercise of the Licensed Rights is expressly made subject to the following conditions.

Attribution.

If You Share the Licensed Material (including in modified form), You must:

- retain the following if it is supplied by the Licensor with the Licensed Material:
 - identification of the creator(s) of the Licensed Material and any others designated a copyright notice;
 - a notice that refers to this Public License;
 - a notice that refers to the disclaimer of warranties;
 - a URI or hyperlink to the Licensed Material to the extent reasonably practicable;
- indicate if You modified the Licensed Material and retain an indication of any previous modifications;
- indicate the Licensed Material is licensed under this Public License, and include the text of this Public License in the Licensed Material.

You may satisfy the conditions in Section 3(a)(1) in any reasonable manner based on the medium in which You share the Licensed Material.

If requested by the Licensor, You must remove any of the information required by Section 3(a) if You share the Licensed Material.

In addition to the conditions in Section 3(a), if You Share Adapted Material You produce, the license for the Adapted Material You apply must be a Creative Commons license with the same License Elements as the Licensed Material. You must include the text of, or the URI or hyperlink to, the Adapter's License You apply. You may not offer or impose any additional or different terms or conditions on, or apply any

Section 4 Sui Generis Database Rights.

Where the Licensed Rights include Sui Generis Database Rights that apply to Your use of the Licensed Material, for the avoidance of doubt, Section 2(a)(1) grants You the right to extract, reuse, reproduce, a substantial portion of the database contents in a database in which You share the Licensed Material. You must comply with the conditions in Section 3(a) if You Share all or a substantial portion of

For the avoidance of doubt, this Section 4 supplements and does not replace Your obligations under t

Section 5 Disclaimer of Warranties and Limitation of Liability.

Unless otherwise separately undertaken by the Licensor, to the extent possible, the Licensor off To the extent possible, in no event will the Licensor be liable to You on any legal theory (incl

The disclaimer of warranties and limitation of liability provided above shall be interpreted in

Section 6 Term and Termination.

This Public License applies for the term of the Copyright and Similar Rights licensed here. Howe

Where Your right to use the Licensed Material has terminated under Section 6(a), it reinstates: automatically as of the date the violation is cured, provided it is cured within 30 days of upon express reinstatement by the Licensor.

For the avoidance of doubt, this Section 6(b) does not affect any right the Licensor may have to For the avoidance of doubt, the Licensor may also offer the Licensed Material under separate ter Sections 1, 5, 6, 7, and 8 survive termination of this Public License.

Section 7 Other Terms and Conditions.

The Licensor shall not be bound by any additional or different terms or conditions communicated Any arrangements, understandings, or agreements regarding the Licensed Material not stated herei

Section 8 Interpretation.

For the avoidance of doubt, this Public License does not, and shall not be interpreted to, reduc To the extent possible, if any provision of this Public License is deemed unenforceable, it shall No term or condition of this Public License will be waived and no failure to comply consented to Nothing in this Public License constitutes or may be interpreted as a limitation upon, or waiver

Creative Commons is not a party to its public licenses. Notwithstanding, Creative Commons may elect
Creative Commons may be contacted at creativecommons.org.



Affero GNU General Public License

Version 3, 19 November 2007

Copyright © 2007 Free Software Foundation, Inc. <http://fsf.org/>

Everyone is permitted to copy and distribute verbatim copies of this license document, but changing it is not allowed.

The GNU Affero General Public License is a free, copyleft license for software and other kinds of works, specifically designed to ensure cooperation with the community in the case of network server software.

The licenses for most software and other practical works are designed to take away your freedom to share and change the works. By contrast, our General Public Licenses are intended to guarantee your freedom to share and change all versions of a program—to make sure it remains free software for all its users.

When we speak of free software, we are referring to freedom, not price. Our General Public Licenses are designed to make sure that you have the freedom to distribute copies of free software (and charge for them if you wish), that you receive source code or can get it if you want it, that you can change the software or use pieces of it in new free programs, and that you know you can do these things.

Developers that use our General Public Licenses protect your rights with two steps: (1) assert copyright on the software, and (2) offer you this License which gives you legal permission to copy, distribute and/or modify the software.

A secondary benefit of defending all users' freedom is that improvements made in alternate versions of the program, if they receive widespread use, become available for other developers to incorporate. Many developers of free software are heartened and encouraged by the resulting cooperation. However, in the case of software used on network servers, this result may fail to come about. The GNU General Public License permits making a modified version and letting the public access it on a server without ever releasing its source code to the public.

The GNU Affero General Public License is designed specifically to ensure that, in such cases, the modified source code becomes available to the community. It requires the operator of a network server to provide the source code of the modified version running there to the users of that server. Therefore, public use of a modified version, on a publicly accessible server, gives the public access to the source code of the modified version.

An older license, called the Affero General Public License and published by Affero, was designed to accomplish similar goals. This is a different license, not a version of the Affero GPL, but Affero has released a new version of the Affero GPL which permits relicensing under this license.

The precise terms and conditions for copying, distribution and modification follow.

TERMS AND CONDITIONS

0. Definitions.

“This License” refers to version 3 of the GNU Affero General Public License.

“Copyright” also means copyright-like laws that apply to other kinds of works, such as semiconductor masks.

“The Program” refers to any copyrightable work licensed under this License. Each licensee is addressed as “you”. “Licensees” and “recipients” may be individuals or organizations.

To “modify” a work means to copy from or adapt all or part of the work in a fashion requiring copyright permission, other than the making of an exact copy. The resulting work is called a “modified version” of the earlier work or a work “based on” the earlier work.

A “covered work” means either the unmodified Program or a work based on the Program.

To “propagate” a work means to do anything with it that, without permission, would make you directly or secondarily liable for infringement under applicable copyright law, except executing it on a computer or modifying a private copy. Propagation includes copying, distribution (with or without modification), making available to the public, and in some countries other activities as well.

To “convey” a work means any kind of propagation that enables other parties to make or receive copies. Mere interaction with a user through a computer network, with no transfer of a copy, is not conveying.

An interactive user interface displays “Appropriate Legal Notices” to the extent that it includes a convenient and prominently visible feature that (1) displays an appropriate copyright notice, and (2) tells the user that there is no warranty for the work (except to the extent that warranties are provided), that licensees may convey the work under this License, and how to view a copy of this License. If the



interface presents a list of user commands or options, such as a menu, a prominent item in the list meets this criterion.

1. Source Code.

The “source code” for a work means the preferred form of the work for making modifications to it. “Object code” means any non-source form of a work.

A “Standard Interface” means an interface that either is an official standard defined by a recognized standards body, or, in the case of interfaces specified for a particular programming language, one that is widely used among developers working in that language.

The “System Libraries” of an executable work include anything, other than the work as a whole, that (a) is included in the normal form of packaging a Major Component, but which is not part of that Major Component, and (b) serves only to enable use of the work with that Major Component, or to implement a Standard Interface for which an implementation is available to the public in source code form. A “Major Component”, in this context, means a major essential component (kernel, window system, and so on) of the specific operating system (if any) on which the executable work runs, or a compiler used to produce the work, or an object code interpreter used to run it.

The “Corresponding Source” for a work in object code form means all the source code needed to generate, install, and (for an executable work) run the object code and to modify the work, including scripts to control those activities. However, it does not include the work’s System Libraries, or general-purpose tools or generally available free programs which are used unmodified in performing those activities but which are not part of the work. For example, Corresponding Source includes interface definition files associated with source files for the work, and the source code for shared libraries and dynamically linked subprograms that the work is specifically designed to require, such as by intimate data communication or control flow between those subprograms and other parts of the work.

The Corresponding Source need not include anything that users can regenerate automatically from other parts of the Corresponding Source.

The Corresponding Source for a work in source code form is that same work.

2. Basic Permissions.

All rights granted under this License are granted for the term of copyright on the Program, and are irrevocable provided the stated conditions are met. This License explicitly affirms your unlimited permission to run the unmodified Program. The output from running a covered work is covered by this License only if the output, given its content, constitutes a covered work. This License acknowledges your rights of fair use or other equivalent, as provided by copyright law.

You may make, run and propagate covered works that you do not convey, without conditions so long as your license otherwise remains in force. You may convey covered works to others for the sole purpose of having them make modifications exclusively for you, or provide you with facilities for running those works, provided that you comply with the terms of this License in conveying all material for which you do not control copyright. Those thus making or running the covered works for you must do so exclusively on your behalf, under your direction and control, on terms that prohibit them from making any copies of your copyrighted material outside their relationship with you.

Conveying under any other circumstances is permitted solely under the conditions stated below. Sub-licensing is not allowed; section 10 makes it unnecessary.

3. Protecting Users’ Legal Rights From Anti-Circumvention Law.

No covered work shall be deemed part of an effective technological measure under any applicable law fulfilling obligations under article 11 of the WIPO copyright treaty adopted on 20 December 1996, or similar laws prohibiting or restricting circumvention of such measures.

When you convey a covered work, you waive any legal power to forbid circumvention of technological measures to the extent such circumvention is effected by exercising rights under this License with respect to the covered work, and you disclaim any intention to limit operation or modification of the work as a means of enforcing, against the work’s users, your or third parties’ legal rights to forbid circumvention of technological measures.

4. Conveying Verbatim Copies.

You may convey verbatim copies of the Program’s source code as you receive it, in any medium, provided that you conspicuously and appropriately publish on each copy an appropriate copyright notice; keep intact all notices stating that this License and any non-permissive terms added in accord



with section 7 apply to the code; keep intact all notices of the absence of any warranty; and give all recipients a copy of this License along with the Program.

You may charge any price or no price for each copy that you convey, and you may offer support or warranty protection for a fee.

5. Conveying Modified Source Versions.

You may convey a work based on the Program, or the modifications to produce it from the Program, in the form of source code under the terms of section 4, provided that you also meet all of these conditions:

- (a) The work must carry prominent notices stating that you modified it, and giving a relevant date.
- (b) The work must carry prominent notices stating that it is released under this License and any conditions added under section 7. This requirement modifies the requirement in section 4 to “keep intact all notices”.
- (c) You must license the entire work, as a whole, under this License to anyone who comes into possession of a copy. This License will therefore apply, along with any applicable section 7 additional terms, to the whole of the work, and all its parts, regardless of how they are packaged. This License gives no permission to license the work in any other way, but it does not invalidate such permission if you have separately received it.
- (d) If the work has interactive user interfaces, each must display Appropriate Legal Notices; however, if the Program has interactive interfaces that do not display Appropriate Legal Notices, your work need not make them do so.

A compilation of a covered work with other separate and independent works, which are not by their nature extensions of the covered work, and which are not combined with it such as to form a larger program, in or on a volume of a storage or distribution medium, is called an “aggregate” if the compilation and its resulting copyright are not used to limit the access or legal rights of the compilation’s users beyond what the individual works permit. Inclusion of a covered work in an aggregate does not cause this License to apply to the other parts of the aggregate.

6. Conveying Non-Source Forms.

You may convey a covered work in object code form under the terms of sections 4 and 5, provided that you also convey the machine-readable Corresponding Source under the terms of this License, in one of these ways:

- (a) Convey the object code in, or embodied in, a physical product (including a physical distribution medium), accompanied by the Corresponding Source fixed on a durable physical medium customarily used for software interchange.
- (b) Convey the object code in, or embodied in, a physical product (including a physical distribution medium), accompanied by a written offer, valid for at least three years and valid for as long as you offer spare parts or customer support for that product model, to give anyone who possesses the object code either (1) a copy of the Corresponding Source for all the software in the product that is covered by this License, on a durable physical medium customarily used for software interchange, for a price no more than your reasonable cost of physically performing this conveying of source, or (2) access to copy the Corresponding Source from a network server at no charge.
- (c) Convey individual copies of the object code with a copy of the written offer to provide the Corresponding Source. This alternative is allowed only occasionally and noncommercially, and only if you received the object code with such an offer, in accord with subsection 6b.
- (d) Convey the object code by offering access from a designated place (gratis or for a charge), and offer equivalent access to the Corresponding Source in the same way through the same place at no further charge. You need not require recipients to copy the Corresponding Source along with the object code. If the place to copy the object code is a network server, the Corresponding Source may be on a different server (operated by you or a third party) that supports equivalent copying facilities, provided you maintain clear directions next to the object code saying where to find the Corresponding Source. Regardless of what server hosts the Corresponding Source, you remain obligated to ensure that it is available for as long as needed to satisfy these requirements.
- (e) Convey the object code using peer-to-peer transmission, provided you inform other peers where the object code and Corresponding Source of the work are being offered to the general public at no charge under subsection 6d.

A separable portion of the object code, whose source code is excluded from the Corresponding Source as a System Library, need not be included in conveying the object code work.

A “User Product” is either (1) a “consumer product”, which means any tangible personal property which is normally used for personal, family, or household purposes, or (2) anything designed or sold for incorporation into a dwelling. In determining whether a product is a consumer product, doubtful cases shall be resolved in favor of coverage. For a particular product received by a particular user, “normally used” refers to a typical or common use of that class of product, regardless of the status of the particular user or of the way in which the particular user actually uses, or expects or is expected to use, the product. A product is a consumer product regardless of whether the product has substantial commercial, industrial or non-consumer uses, unless such uses represent the only significant mode of use of the product.

“Installation Information” for a User Product means any methods, procedures, authorization keys, or other information required to install and execute modified versions of a covered work in that User Product from a modified version of its Corresponding Source. The information must suffice to ensure that the continued functioning of the modified object code is in no case prevented or interfered with solely because modification has been made.

If you convey an object code work under this section in, or with, or specifically for use in, a User Product, and the conveying occurs as part of a transaction in which the right of possession and use of the User Product is transferred to the recipient in perpetuity or for a fixed term (regardless of how the transaction is characterized), the Corresponding Source conveyed under this section must be accompanied by the Installation Information. But this requirement does not apply if neither you nor any third party retains the ability to install modified object code on the User Product (for example, the work has been installed in ROM).

The requirement to provide Installation Information does not include a requirement to continue to provide support service, warranty, or updates for a work that has been modified or installed by the recipient, or for the User Product in which it has been modified or installed. Access to a network may be denied when the modification itself materially and adversely affects the operation of the network or violates the rules and protocols for communication across the network.

Corresponding Source conveyed, and Installation Information provided, in accord with this section must be in a format that is publicly documented (and with an implementation available to the public in source code form), and must require no special password or key for unpacking, reading or copying.

7. Additional Terms.

“Additional permissions” are terms that supplement the terms of this License by making exceptions from one or more of its conditions. Additional permissions that are applicable to the entire Program shall be treated as though they were included in this License, to the extent that they are valid under applicable law. If additional permissions apply only to part of the Program, that part may be used separately under those permissions, but the entire Program remains governed by this License without regard to the additional permissions.

When you convey a copy of a covered work, you may at your option remove any additional permissions from that copy, or from any part of it. (Additional permissions may be written to require their own removal in certain cases when you modify the work.) You may place additional permissions on material, added by you to a covered work, for which you have or can give appropriate copyright permission.

Notwithstanding any other provision of this License, for material you add to a covered work, you may (if authorized by the copyright holders of that material) supplement the terms of this License with terms:

- (a) Disclaiming warranty or limiting liability differently from the terms of sections 15 and 16 of this License; or
- (b) Requiring preservation of specified reasonable legal notices or author attributions in that material or in the Appropriate Legal Notices displayed by works containing it; or
- (c) Prohibiting misrepresentation of the origin of that material, or requiring that modified versions of such material be marked in reasonable ways as different from the original version; or
- (d) Limiting the use for publicity purposes of names of licensors or authors of the material; or
- (e) Declining to grant rights under trademark law for use of some trade names, trademarks, or service marks; or



- (f) Requiring indemnification of licensors and authors of that material by anyone who conveys the material (or modified versions of it) with contractual assumptions of liability to the recipient, for any liability that these contractual assumptions directly impose on those licensors and authors.

All other non-permissive additional terms are considered “further restrictions” within the meaning of section 10. If the Program as you received it, or any part of it, contains a notice stating that it is governed by this License along with a term that is a further restriction, you may remove that term. If a license document contains a further restriction but permits relicensing or conveying under this License, you may add to a covered work material governed by the terms of that license document, provided that the further restriction does not survive such relicensing or conveying.

If you add terms to a covered work in accord with this section, you must place, in the relevant source files, a statement of the additional terms that apply to those files, or a notice indicating where to find the applicable terms.

Additional terms, permissive or non-permissive, may be stated in the form of a separately written license, or stated as exceptions; the above requirements apply either way.

8. Termination.

You may not propagate or modify a covered work except as expressly provided under this License. Any attempt otherwise to propagate or modify it is void, and will automatically terminate your rights under this License (including any patent licenses granted under the third paragraph of section 11).

However, if you cease all violation of this License, then your license from a particular copyright holder is reinstated (a) provisionally, unless and until the copyright holder explicitly and finally terminates your license, and (b) permanently, if the copyright holder fails to notify you of the violation by some reasonable means prior to 60 days after the cessation.

Moreover, your license from a particular copyright holder is reinstated permanently if the copyright holder notifies you of the violation by some reasonable means, this is the first time you have received notice of violation of this License (for any work) from that copyright holder, and you cure the violation prior to 30 days after your receipt of the notice.

Termination of your rights under this section does not terminate the licenses of parties who have received copies or rights from you under this License. If your rights have been terminated and not permanently reinstated, you do not qualify to receive new licenses for the same material under section 10.

9. Acceptance Not Required for Having Copies.

You are not required to accept this License in order to receive or run a copy of the Program. Ancillary propagation of a covered work occurring solely as a consequence of using peer-to-peer transmission to receive a copy likewise does not require acceptance. However, nothing other than this License grants you permission to propagate or modify any covered work. These actions infringe copyright if you do not accept this License. Therefore, by modifying or propagating a covered work, you indicate your acceptance of this License to do so.

10. Automatic Licensing of Downstream Recipients.

Each time you convey a covered work, the recipient automatically receives a license from the original licensors, to run, modify and propagate that work, subject to this License. You are not responsible for enforcing compliance by third parties with this License.

An “entity transaction” is a transaction transferring control of an organization, or substantially all assets of one, or subdividing an organization, or merging organizations. If propagation of a covered work results from an entity transaction, each party to that transaction who receives a copy of the work also receives whatever licenses to the work the party’s predecessor in interest had or could give under the previous paragraph, plus a right to possession of the Corresponding Source of the work from the predecessor in interest, if the predecessor has it or can get it with reasonable efforts.

You may not impose any further restrictions on the exercise of the rights granted or affirmed under this License. For example, you may not impose a license fee, royalty, or other charge for exercise of rights granted under this License, and you may not initiate litigation (including a cross-claim or counterclaim in a lawsuit) alleging that any patent claim is infringed by making, using, selling, offering for sale, or importing the Program or any portion of it.



11. Patents.

A “contributor” is a copyright holder who authorizes use under this License of the Program or a work on which the Program is based. The work thus licensed is called the contributor’s “contributor version”.

A contributor’s “essential patent claims” are all patent claims owned or controlled by the contributor, whether already acquired or hereafter acquired, that would be infringed by some manner, permitted by this License, of making, using, or selling its contributor version, but do not include claims that would be infringed only as a consequence of further modification of the contributor version. For purposes of this definition, “control” includes the right to grant patent sublicenses in a manner consistent with the requirements of this License.

Each contributor grants you a non-exclusive, worldwide, royalty-free patent license under the contributor’s essential patent claims, to make, use, sell, offer for sale, import and otherwise run, modify and propagate the contents of its contributor version.

In the following three paragraphs, a “patent license” is any express agreement or commitment, however denominated, not to enforce a patent (such as an express permission to practice a patent or covenant not to sue for patent infringement). To “grant” such a patent license to a party means to make such an agreement or commitment not to enforce a patent against the party.

If you convey a covered work, knowingly relying on a patent license, and the Corresponding Source of the work is not available for anyone to copy, free of charge and under the terms of this License, through a publicly available network server or other readily accessible means, then you must either (1) cause the Corresponding Source to be so available, or (2) arrange to deprive yourself of the benefit of the patent license for this particular work, or (3) arrange, in a manner consistent with the requirements of this License, to extend the patent license to downstream recipients. “Knowingly relying” means you have actual knowledge that, but for the patent license, your conveying the covered work in a country, or your recipient’s use of the covered work in a country, would infringe one or more identifiable patents in that country that you have reason to believe are valid.

If, pursuant to or in connection with a single transaction or arrangement, you convey, or propagate by procuring conveyance of, a covered work, and grant a patent license to some of the parties receiving the covered work authorizing them to use, propagate, modify or convey a specific copy of the covered work, then the patent license you grant is automatically extended to all recipients of the covered work and works based on it.

A patent license is “discriminatory” if it does not include within the scope of its coverage, prohibits the exercise of, or is conditioned on the non-exercise of one or more of the rights that are specifically granted under this License. You may not convey a covered work if you are a party to an arrangement with a third party that is in the business of distributing software, under which you make payment to the third party based on the extent of your activity of conveying the work, and under which the third party grants, to any of the parties who would receive the covered work from you, a discriminatory patent license (a) in connection with copies of the covered work conveyed by you (or copies made from those copies), or (b) primarily for and in connection with specific products or compilations that contain the covered work, unless you entered into that arrangement, or that patent license was granted, prior to 28 March 2007.

Nothing in this License shall be construed as excluding or limiting any implied license or other defenses to infringement that may otherwise be available to you under applicable patent law.

12. No Surrender of Others’ Freedom.

If conditions are imposed on you (whether by court order, agreement or otherwise) that contradict the conditions of this License, they do not excuse you from the conditions of this License. If you cannot convey a covered work so as to satisfy simultaneously your obligations under this License and any other pertinent obligations, then as a consequence you may not convey it at all. For example, if you agree to terms that obligate you to collect a royalty for further conveying from those to whom you convey the Program, the only way you could satisfy both those terms and this License would be to refrain entirely from conveying the Program.

13. Remote Network Interaction; Use with the GNU General Public License.

Notwithstanding any other provision of this License, if you modify the Program, your modified version must prominently offer all users interacting with it remotely through a computer network (if your version supports such interaction) an opportunity to receive the Corresponding Source of your version by providing access to the Corresponding Source from a network server at no charge, through some



standard or customary means of facilitating copying of software. This Corresponding Source shall include the Corresponding Source for any work covered by version 3 of the GNU General Public License that is incorporated pursuant to the following paragraph.

Notwithstanding any other provision of this License, you have permission to link or combine any covered work with a work licensed under version 3 of the GNU General Public License into a single combined work, and to convey the resulting work. The terms of this License will continue to apply to the part which is the covered work, but the work with which it is combined will remain governed by version 3 of the GNU General Public License.

14. Revised Versions of this License.

The Free Software Foundation may publish revised and/or new versions of the GNU Affero General Public License from time to time. Such new versions will be similar in spirit to the present version, but may differ in detail to address new problems or concerns.

Each version is given a distinguishing version number. If the Program specifies that a certain numbered version of the GNU Affero General Public License “or any later version” applies to it, you have the option of following the terms and conditions either of that numbered version or of any later version published by the Free Software Foundation. If the Program does not specify a version number of the GNU Affero General Public License, you may choose any version ever published by the Free Software Foundation.

If the Program specifies that a proxy can decide which future versions of the GNU Affero General Public License can be used, that proxy’s public statement of acceptance of a version permanently authorizes you to choose that version for the Program.

Later license versions may give you additional or different permissions. However, no additional obligations are imposed on any author or copyright holder as a result of your choosing to follow a later version.

15. Disclaimer of Warranty.

THERE IS NO WARRANTY FOR THE PROGRAM, TO THE EXTENT PERMITTED BY APPLICABLE LAW. EXCEPT WHEN OTHERWISE STATED IN WRITING THE COPYRIGHT HOLDERS AND/OR OTHER PARTIES PROVIDE THE PROGRAM “AS IS” WITHOUT WARRANTY OF ANY KIND, EITHER EXPRESSED OR IMPLIED, INCLUDING, BUT NOT LIMITED TO, THE IMPLIED WARRANTIES OF MERCHANTABILITY AND FITNESS FOR A PARTICULAR PURPOSE. THE ENTIRE RISK AS TO THE QUALITY AND PERFORMANCE OF THE PROGRAM IS WITH YOU. SHOULD THE PROGRAM PROVE DEFECTIVE, YOU ASSUME THE COST OF ALL NECESSARY SERVICING, REPAIR OR CORRECTION.

16. Limitation of Liability.

IN NO EVENT UNLESS REQUIRED BY APPLICABLE LAW OR AGREED TO IN WRITING WILL ANY COPYRIGHT HOLDER, OR ANY OTHER PARTY WHO MODIFIES AND/OR CONVEYS THE PROGRAM AS PERMITTED ABOVE, BE LIABLE TO YOU FOR DAMAGES, INCLUDING ANY GENERAL, SPECIAL, INCIDENTAL OR CONSEQUENTIAL DAMAGES ARISING OUT OF THE USE OR INABILITY TO USE THE PROGRAM (INCLUDING BUT NOT LIMITED TO LOSS OF DATA OR DATA BEING RENDERED INACCURATE OR LOSSES SUSTAINED BY YOU OR THIRD PARTIES OR A FAILURE OF THE PROGRAM TO OPERATE WITH ANY OTHER PROGRAMS), EVEN IF SUCH HOLDER OR OTHER PARTY HAS BEEN ADVISED OF THE POSSIBILITY OF SUCH DAMAGES.

17. Interpretation of Sections 15 and 16.

If the disclaimer of warranty and limitation of liability provided above cannot be given local legal effect according to their terms, reviewing courts shall apply local law that most closely approximates an absolute waiver of all civil liability in connection with the Program, unless a warranty or assumption of liability accompanies a copy of the Program in return for a fee.

END OF TERMS AND CONDITIONS

How to Apply These Terms to Your New Programs



If you develop a new program, and you want it to be of the greatest possible use to the public, the best way to achieve this is to make it free software which everyone can redistribute and change under these terms.

To do so, attach the following notices to the program. It is safest to attach them to the start of each source file to most effectively state the exclusion of warranty; and each file should have at least the “copyright” line and a pointer to where the full notice is found.

```
<one line to give the program's name and a brief idea of what it does.>
```

```
Copyright (C) <textyear> <name of author>
```

```
This program is free software: you can redistribute it and/or modify  
it under the terms of the GNU Affero General Public License as published by  
the Free Software Foundation, either version 3 of the License, or  
(at your option) any later version.
```

```
This program is distributed in the hope that it will be useful,  
but WITHOUT ANY WARRANTY; without even the implied warranty of  
MERCHANTABILITY or FITNESS FOR A PARTICULAR PURPOSE. See the  
GNU Affero General Public License for more details.
```

```
You should have received a copy of the GNU Affero General Public License  
along with this program. If not, see <http://www.gnu.org/licenses/>.
```

Also add information on how to contact you by electronic and paper mail.

If your software can interact with users remotely through a computer network, you should also make sure that it provides a way for users to get its source. For example, if your program is a web application, its interface could display a “Source” link that leads users to an archive of the code. There are many ways you could offer source, and different solutions will be better for different programs; see section 13 for the specific requirements.

You should also get your employer (if you work as a programmer) or school, if any, to sign a “copyright disclaimer” for the program, if necessary. For more information on this, and how to apply and follow the GNU AGPL, see <http://www.gnu.org/licenses/>.



GNU Lesser General Public License

image of a Philosophical GNU [English — Japanese]

- Why you shouldn't use the Lesser GPL for your next library
- What to do if you see a possible LGPL violation
- Translations of the LGPL
- The GNU Lesser General Public License as a text file
- The GNU Lesser General Public License as a Texinfo file

This GNU Lesser General Public License counts as the successor of the GNU Library General Public License. For an explanation of why this change was necessary, read the Why you shouldn't use the Lesser GPL for your next library article.

45.9 Table of Contents

- GNU LESSER GENERAL PUBLIC LICENSE
 - Preamble
 - TERMS AND CONDITIONS FOR COPYING, DISTRIBUTION AND MODIFICATION
 - How to Apply These Terms to Your New Libraries

45.10 GNU LESSER GENERAL PUBLIC LICENSE

Version 2.1, February 1999

Copyright (C) 1991, 1999 Free Software Foundation, Inc.
51 Franklin St, Fifth Floor, Boston, MA 02110-1301 USA
Everyone is permitted to copy and distribute verbatim copies
of this license document, but changing it is not allowed.
[This is the first released version of the Lesser GPL. It also counts
as the successor of the GNU Library Public License, version 2, hence
the version number 2.1.]

45.11 Preamble

The licenses for most software are designed to take away your freedom to share and change it. By contrast, the GNU General Public Licenses are intended to guarantee your freedom to share and change free software--to make sure the software is free for all its users.

This license, the Lesser General Public License, applies to some specially designated software packages--typically libraries--of the Free Software Foundation and other authors who decide to use it. You can use it too, but we suggest you first think carefully about whether this license or the ordinary General Public License is the better strategy to use in any particular case, based on the explanations below. When we speak of free software, we are referring to freedom of use, not price. Our General Public Licenses are designed to make sure that you have the freedom to distribute copies of free software (and charge for this service if you wish); that you receive source code or can get it if you want it; that you can change the software and use pieces of it in new free programs; and that you are informed that you can do these things. To protect your rights, we need to make restrictions that forbid distributors to deny you these rights or to ask you to surrender these rights. These restrictions translate to certain responsibilities for you if you distribute copies of the library or if you modify it.

For example, if you distribute copies of the library, whether gratis or for a fee, you must give the recipients all the rights that we gave you. You must make sure that they, too, receive or can get the source code. If you link other code with the library, you must provide complete object files to the recipients, so that they can relink them with the library after making changes to the library and recompiling it. And you must show them these terms so they know their rights.

We protect your rights with a two-step method: (1) we copyright the library, and (2) we offer you this license, which gives you legal permission to copy, distribute and/or modify the library.

To protect each distributor, we want to make it very clear that there is no warranty for the free library. Also, if the library is modified by someone else and passed on, the recipients should know that what they have is not the original version, so that the original author's reputation will not be affected by problems that might be introduced by others.

Finally, software patents pose a constant threat to the existence of any free program. We wish to make sure that a company cannot effectively restrict the users of a free program by obtaining a restrictive license from a patent holder. Therefore, we insist that any patent license obtained for a version of the library must be consistent with the full freedom of use specified in this license.

Most GNU software, including some libraries, is covered by the ordinary GNU General Public License. This license, the GNU Lesser General Public License, applies to certain designated libraries, and is quite different from the ordinary General Public License. We use this license for certain libraries in order to permit linking those libraries into non-free programs.

When a program is linked with a library, whether statically or using a shared library, the combination of the two is legally speaking a combined work, a derivative of the original library. The ordinary General Public License therefore permits such linking only if the entire combination fits its criteria of freedom. The Lesser General Public License permits more lax criteria for linking other code with the library.

We call this license the "Lesser" General Public License because it does Less to protect the user's freedom than the ordinary General Public License. It also provides other free software developers Less of an advantage over competing non-free programs. These disadvantages are the reason we use the ordinary General Public License for many libraries. However, the Lesser license provides advantages in certain special circumstances.

For example, on rare occasions, there may be a special need to encourage the widest possible use of a certain library, so that it becomes a de-facto standard. To achieve this, non-free programs must be allowed to use the library. A more frequent case is that a free library does the same job as widely used non-free libraries. In this case, there is little to gain by limiting the free library to free software only, so we use the Lesser General Public License.

In other cases, permission to use a particular library in non-free programs enables a greater number of people to use a large body of free software. For example, permission to use the GNU C Library in non-free programs enables many more people to use the whole GNU operating system, as well as its variant, the GNU/Linux operating system.

Although the Lesser General Public License is Less protective of the users' freedom, it does ensure that the user of a program that is linked with the Library has the freedom and the wherewithal to run that program using a modified version of the Library.

The precise terms and conditions for copying, distribution and modification follow. Pay close attention to the difference between a "work based on the library" and a "work that uses the library". The former contains code derived from the library, whereas the latter must be combined with the library in order to run.

45.12 TERMS AND CONDITIONS

TERMS AND CONDITIONS FOR COPYING, DISTRIBUTION AND MODIFICATION

0. This License Agreement applies to any software library or other program which contains a notice placed by the copyright holder or other authorized party saying it may be distributed under the terms of this Lesser General Public License (also called "this License"). Each licensee is addressed as "you".

A "library" means a collection of software functions and/or data prepared so as to be conveniently linked with application programs (which use some of those functions and data) to form executables.

The "Library", below, refers to any such software library or work which has been distributed under these terms. A "work based on the Library" means either the Library or any derivative work under copyright law: that is to say, a work containing the Library or a portion of it, either verbatim or with modifications and/or translated straightforwardly into another language. (Hereinafter, translation is included without limitation in the term "modification".)

"Source code" for a work means the preferred form of the work for making modifications to it. For a library, complete source code means all the source code for all modules it contains, plus any associated interface definition files, plus the scripts used to control compilation and installation of the library.

Activities other than copying, distribution and modification are not covered by this License; they are outside its scope. The act of running a program using the Library is not restricted, and output from such a program is covered only if its contents constitute a work based on the Library (independent of the use of the Library in a tool for writing it). Whether that is true depends on what the Library does and what the program that uses the Library does.

1. You may copy and distribute verbatim copies of the Library's complete source code as you receive it, in any medium, provided that you conspicuously and appropriately publish on each copy an appropriate



copyright notice and disclaimer of warranty; keep intact all the notices that refer to this License and to the absence of any warranty; and distribute a copy of this License along with the Library.

You may charge a fee for the physical act of transferring a copy, and you may at your option offer warranty protection in exchange for a fee.

2. You may modify your copy or copies of the Library or any portion of it, thus forming a work based on the Library, and copy and distribute such modifications or work under the terms of Section 1 above, provided that you also meet all of these conditions:

- **a)** The modified work must itself be a software library.
- **b)** You must cause the files modified to carry prominent notices stating that you changed the files and the date of any change.
- **c)** You must cause the whole of the work to be licensed at no charge to all third parties under the terms of this License.
- **d)** If a facility in the modified Library refers to a function or a table of data to be supplied by an application program that uses the facility, other than as an argument passed when the facility is invoked, then you must make a good faith effort to ensure that, in the event an application does not supply such function or table, the facility still operates, and performs whatever part of its purpose remains meaningful.

(For example, a function in a library to compute square roots has a purpose that is entirely well-defined independent of the application. Therefore, Subsection 2d requires that any application-supplied function or table used by this function must be optional: if the application does not supply it, the square root function must still compute square roots.)

These requirements apply to the modified work as a whole. If identifiable sections of that work are not derived from the Library, and can be reasonably considered independent and separate works in themselves, then this License, and its terms, do not apply to those sections when you distribute them as separate works. But when you distribute the same sections as part of a whole which is a work based on the Library, the distribution of the whole must be on the terms of this License, whose permissions for other licensees extend to the entire whole, and thus to each and every part regardless of who wrote it.

Thus, it is not the intent of this section to claim rights or contest your rights to work written entirely by you; rather, the intent is to exercise the right to control the distribution of derivative or collective works based on the Library.

In addition, mere aggregation of another work not based on the Library with the Library (or with a work based on the Library) on a volume of a storage or distribution medium does not bring the other work under the scope of this License.

3. You may opt to apply the terms of the ordinary GNU General Public License instead of this License to a given copy of the Library. To do this, you must alter all the notices that refer to this License, so that they refer to the ordinary GNU General Public License, version 2, instead of to this License. (If a newer version than version 2 of the ordinary GNU General Public License has appeared, then you can specify that version instead if you wish.) Do not make any other change in these notices.

Once this change is made in a given copy, it is irreversible for that copy, so the ordinary GNU General Public License applies to all subsequent copies and derivative works made from that copy.

This option is useful when you wish to copy part of the code of the Library into a program that is not a library.

4. You may copy and distribute the Library (or a portion or derivative of it, under Section 2) in object code or executable form under the terms of Sections 1 and 2 above provided that you accompany it with the complete corresponding machine-readable source code, which must be distributed under the terms of Sections 1 and 2 above on a medium customarily used for software interchange.

If distribution of object code is made by offering access to copy from a designated place, then offering equivalent access to copy the source code from the same place satisfies the requirement to distribute the source code, even though third parties are not compelled to copy the source along with the object code.

5. A program that contains no derivative of any portion of the Library, but is designed to work with the Library by being compiled or linked with it, is called a "work that uses the Library". Such a work, in isolation, is not a derivative work of the Library, and therefore falls outside the scope of this License.

However, linking a "work that uses the Library" with the Library creates an executable that is a derivative of the Library (because it contains portions of the Library), rather than a "work that uses the library". The executable is therefore covered by this License. Section 6 states terms for distribution of such executables.



When a "work that uses the Library" uses material from a header file that is part of the Library, the object code for the work may be a derivative work of the Library even though the source code is not. Whether this is true is especially significant if the work can be linked without the Library, or if the work is itself a library. The threshold for this to be true is not precisely defined by law.

If such an object file uses only numerical parameters, data structure layouts and accessors, and small macros and small inline functions (ten lines or less in length), then the use of the object file is unrestricted, regardless of whether it is legally a derivative work. (Executables containing this object code plus portions of the Library will still fall under Section 6.)

Otherwise, if the work is a derivative of the Library, you may distribute the object code for the work under the terms of Section 6. Any executables containing that work also fall under Section 6, whether or not they are linked directly with the Library itself.

6. As an exception to the Sections above, you may also combine or link a "work that uses the Library" with the Library to produce a work containing portions of the Library, and distribute that work under terms of your choice, provided that the terms permit modification of the work for the customer's own use and reverse engineering for debugging such modifications.

You must give prominent notice with each copy of the work that the Library is used in it and that the Library and its use are covered by this License. You must supply a copy of this License. If the work during execution displays copyright notices, you must include the copyright notice for the Library among them, as well as a reference directing the user to the copy of this License. Also, you must do one of these things:

- **a)** Accompany the work with the complete corresponding machine-readable source code for the Library including whatever changes were used in the work (which must be distributed under Sections 1 and 2 above); and, if the work is an executable linked with the Library, with the complete machine-readable "work that uses the Library", as object code and/or source code, so that the user can modify the Library and then relink to produce a modified executable containing the modified Library. (It is understood that the user who changes the contents of definitions files in the Library will not necessarily be able to recompile the application to use the modified definitions.)
- **b)** Use a suitable shared library mechanism for linking with the Library. A suitable mechanism is one that (1) uses at run time a copy of the library already present on the user's computer system, rather than copying library functions into the executable, and (2) will operate properly with a modified version of the library, if the user installs one, as long as the modified version is interface-compatible with the version that the work was made with.
- **c)** Accompany the work with a written offer, valid for at least three years, to give the same user the materials specified in Subsection 6a, above, for a charge no more than the cost of performing this distribution.
- **d)** If distribution of the work is made by offering access to copy from a designated place, offer equivalent access to copy the above specified materials from the same place.
- **e)** Verify that the user has already received a copy of these materials or that you have already sent this user a copy.

For an executable, the required form of the "work that uses the Library" must include any data and utility programs needed for reproducing the executable from it. However, as a special exception, the materials to be distributed need not include anything that is normally distributed (in either source or binary form) with the major components (compiler, kernel, and so on) of the operating system on which the executable runs, unless that component itself accompanies the executable.

It may happen that this requirement contradicts the license restrictions of other proprietary libraries that do not normally accompany the operating system. Such a contradiction means you cannot use both them and the Library together in an executable that you distribute.

7. You may place library facilities that are a work based on the Library side-by-side in a single library together with other library facilities not covered by this License, and distribute such a combined library, provided that the separate distribution of the work based on the Library and of the other library facilities is otherwise permitted, and provided that you do these two things:

- **a)** Accompany the combined library with a copy of the same work based on the Library, uncombined with any other library facilities. This must be distributed under the terms of the Sections above.
- **b)** Give prominent notice with the combined library of the fact that part of it is a work based on the Library, and explaining where to find the accompanying uncombined form of the same work.



8. You may not copy, modify, sublicense, link with, or distribute the Library except as expressly provided under this License. Any attempt otherwise to copy, modify, sublicense, link with, or distribute the Library is void, and will automatically terminate your rights under this License. However, parties who have received copies, or rights, from you under this License will not have their licenses terminated so long as such parties remain in full compliance.

9. You are not required to accept this License, since you have not signed it. However, nothing else grants you permission to modify or distribute the Library or its derivative works. These actions are prohibited by law if you do not accept this License. Therefore, by modifying or distributing the Library (or any work based on the Library), you indicate your acceptance of this License to do so, and all its terms and conditions for copying, distributing or modifying the Library or works based on it.

10. Each time you redistribute the Library (or any work based on the Library), the recipient automatically receives a license from the original licensor to copy, distribute, link with or modify the Library subject to these terms and conditions. You may not impose any further restrictions on the recipients' exercise of the rights granted herein. You are not responsible for enforcing compliance by third parties with this License.

11. If, as a consequence of a court judgment or allegation of patent infringement or for any other reason (not limited to patent issues), conditions are imposed on you (whether by court order, agreement or otherwise) that contradict the conditions of this License, they do not excuse you from the conditions of this License. If you cannot distribute so as to satisfy simultaneously your obligations under this License and any other pertinent obligations, then as a consequence you may not distribute the Library at all. For example, if a patent license would not permit royalty-free redistribution of the Library by all those who receive copies directly or indirectly through you, then the only way you could satisfy both it and this License would be to refrain entirely from distribution of the Library.

If any portion of this section is held invalid or unenforceable under any particular circumstance, the balance of the section is intended to apply, and the section as a whole is intended to apply in other circumstances.

It is not the purpose of this section to induce you to infringe any patents or other property right claims or to contest validity of any such claims; this section has the sole purpose of protecting the integrity of the free software distribution system which is implemented by public license practices. Many people have made generous contributions to the wide range of software distributed through that system in reliance on consistent application of that system; it is up to the author/donor to decide if he or she is willing to distribute software through any other system and a licensee cannot impose that choice.

This section is intended to make thoroughly clear what is believed to be a consequence of the rest of this License.

12. If the distribution and/or use of the Library is restricted in certain countries either by patents or by copyrighted interfaces, the original copyright holder who places the Library under this License may add an explicit geographical distribution limitation excluding those countries, so that distribution is permitted only in or among countries not thus excluded. In such case, this License incorporates the limitation as if written in the body of this License.

13. The Free Software Foundation may publish revised and/or new versions of the Lesser General Public License from time to time. Such new versions will be similar in spirit to the present version, but may differ in detail to address new problems or concerns.

Each version is given a distinguishing version number. If the Library specifies a version number of this License which applies to it and "any later version", you have the option of following the terms and conditions either of that version or of any later version published by the Free Software Foundation. If the Library does not specify a license version number, you may choose any version ever published by the Free Software Foundation.

14. If you wish to incorporate parts of the Library into other free programs whose distribution conditions are incompatible with these, write to the author to ask for permission. For software which is copyrighted by the Free Software Foundation, write to the Free Software Foundation; we sometimes make exceptions for this. Our decision will be guided by the two goals of preserving the free status of all derivatives of our free software and of promoting the sharing and reuse of software generally.

NO WARRANTY

15. BECAUSE THE LIBRARY IS LICENSED FREE OF CHARGE, THERE IS NO WARRANTY FOR THE LIBRARY, TO THE EXTENT PERMITTED BY APPLICABLE LAW. EXCEPT WHEN OTHERWISE STATED IN WRITING THE COPYRIGHT HOLDERS AND/OR OTHER PARTIES PROVIDE THE LIBRARY "AS IS" WITHOUT WARRANTY OF ANY KIND, EITHER EXPRESSED OR IMPLIED, INCLUDING, BUT NOT LIMITED TO, THE IMPLIED WARRANTIES OF MERCHANTABILITY AND FITNESS FOR A PARTICULAR PURPOSE. THE ENTIRE RISK AS TO THE QUALITY AND PERFORMANCE OF THE LIBRARY IS WITH YOU. SHOULD THE LIBRARY PROVE DEFECTIVE, YOU ASSUME THE COST OF ALL NECESSARY SERVICING, REPAIR OR CORRECTION.

16. IN NO EVENT UNLESS REQUIRED BY APPLICABLE LAW OR AGREED TO IN WRITING WILL ANY COPYRIGHT HOLDER, OR ANY OTHER PARTY WHO MAY MODIFY AND/OR RE-



DISTRIBUTE THE LIBRARY AS PERMITTED ABOVE, BE LIABLE TO YOU FOR DAMAGES, INCLUDING ANY GENERAL, SPECIAL, INCIDENTAL OR CONSEQUENTIAL DAMAGES ARISING OUT OF THE USE OR INABILITY TO USE THE LIBRARY (INCLUDING BUT NOT LIMITED TO LOSS OF DATA OR DATA BEING RENDERED INACCURATE OR LOSSES SUSTAINED BY YOU OR THIRD PARTIES OR A FAILURE OF THE LIBRARY TO OPERATE WITH ANY OTHER SOFTWARE), EVEN IF SUCH HOLDER OR OTHER PARTY HAS BEEN ADVISED OF THE POSSIBILITY OF SUCH DAMAGES.

END OF TERMS AND CONDITIONS

45.13 How to Apply These Terms to Your New Libraries

If you develop a new library, and you want it to be of the greatest possible use to the public, we recommend making it free software that everyone can redistribute and change. You can do so by permitting redistribution under these terms (or, alternatively, under the terms of the ordinary General Public License).

To apply these terms, attach the following notices to the library. It is safest to attach them to the start of each source file to most effectively convey the exclusion of warranty; and each file should have at least the "copyright" line and a pointer to where the full notice is found.

```
{\it one line to give the library's name and an idea of what it does.}
Copyright (C) {\it year} {\it name of author}
This library is free software; you can redistribute it and/or
modify it under the terms of the GNU Lesser General Public
License as published by the Free Software Foundation; either
version 2.1 of the License, or (at your option) any later version.
This library is distributed in the hope that it will be useful,
but WITHOUT ANY WARRANTY; without even the implied warranty of
MERCHANTABILITY or FITNESS FOR A PARTICULAR PURPOSE. See the GNU
Lesser General Public License for more details.
You should have received a copy of the GNU Lesser General Public
License along with this library; if not, write to the Free Software
Foundation, Inc., 51 Franklin St, Fifth Floor, Boston, MA 02110-1301
USA
```

Also add information on how to contact you by electronic and paper mail.

You should also get your employer (if you work as a programmer) or your school, if any, to sign a "copyright disclaimer" for the library, if necessary. Here is a sample; alter the names:

```
Yoyodyne, Inc., hereby disclaims all copyright interest in
the library "Frob" (a library for tweaking knobs) written
by James Random Hacker.
{\it signature of Ty Coon}, 1 April 1990
Ty Coon, President of Vice
```

That's all there is to it! Return to GNU's home page .

FSF & GNU inquiries & questions to gnu@gnu.org . Other ways to contact the FSF.

Comments on these web pages to webmasters@www.gnu.org , send other questions to gnu@gnu.org .

Copyright notice above. Free Software Foundation, Inc., 51 Franklin St, Fifth Floor, Boston, MA 02110-1301
USA USA

Updated: 27 Nov 2000 paulv





Chapter 46

Thanks

I thank everyone who has helped this project. Unfortunately, I cannot thank everyone (bad memory). However, the AUTHORS file in the main source code directory should include the names of all persons who have contributed to the Bacula project. Just the same, I would like to include thanks below to special contributors as well as to the major contributors to the current release.

Thanks to Richard Stallman for starting the Free Software movement and for bringing us gcc and all the other GNU tools as well as the GPL license.

Thanks to Linus Torvalds for bringing us Linux.

Thanks to all the Free Software programmers. Without being able to peek at your code, and in some cases, take parts of it, this project would have been much more difficult.

Thanks to John Walker for suggesting this project, giving it a name, contributing software he has written, and for his programming efforts on Bacula as well as having acted as a constant sounding board and source of ideas.

Thanks to the apcupsd project where I started my Free Software efforts, and from which I was able to borrow some ideas and code that I had written.

Special thanks to D. Scott Barninger for writing the bacula RPM spec file, building all the RPM files and loading them onto Source Forge. This has been a tremendous help.

Many thanks to Karl Cunningham for converting the manual from html format to LaTeX. It was a major effort flawlessly done that will benefit the Bacula users for many years to come. Thanks Karl.

Thanks to Dan Langille for the **incredible** amount of testing he did on FreeBSD. His perseverance is truly remarkable. Thanks also for the many contributions he has made to improve Bacula (pthreads patch for FreeBSD, improved start/stop script and addition of Bacula userid and group, stunnel, ...), his continuing support of Bacula users. He also wrote the PostgreSQL driver for Bacula and has been a big help in correcting the SQL.

Thanks to multiple other Bacula Packagers who make and release packages for different platforms for Bacula.

Thanks to Christopher Hull for developing the native Windows Bacula emulation code and for contributing it to the Bacula project.

Thanks to Robert Nelson for bringing our Windows implementation up to par with all the same features that exist in the Unix/Linux versions.

Thanks to Thorsten Engel for his excellent knowledge of Win32 systems, and for making the Windows File daemon Unicode compatible, as well as making the Windows File daemon interface to Microsoft's Volume Shadow Copy (VSS). These two are big pluses for Bacula!

Thanks to Landon Fuller for writing both the communications and the data encryption code for Bacula.

Thanks to Arno Lehmann for his excellent and infatigable help and advice to users.

Thanks to all the Bacula users, especially those of you who have contributed ideas, bug reports, patches, and new features.

Bacula can be enabled with data encryption and/or communications encryption. If this is the case, you will be including OpenSSL code that contains cryptographic software written by Eric Young (eay@cryptsoft.com) and also software written by Tim Hudson (tjh@cryptsoft.com).

The Bat (Bacula Administration Tool) graphs are based in part on the work of the Qwt project (<http://qwt.sf.net>).

The original variable expansion code used in the LabelFormat comes from the Open Source Software Project (www.ossfp.org). It has been adapted and extended for use in Bacula. This code is now deprecated.

There have been numerous people over the years who have contributed ideas, code, and help to the Bacula project. The file AUTHORS in the main source release file contains a list of contributors. For all those who I have left out, please send me a reminder, and in any case, thanks for your contribution.



Thanks to the Free Software Foundation Europe e.V. for assuming the responsibilities of protecting the Bacula copyright.

Copyrights and Trademarks

Certain words and/or products are Copyrighted or Trademarked such as Windows (by Microsoft). Since they are numerous, and we are not necessarily aware of the details of each, we don't try to list them here. However, we acknowledge all such Copyrights and Trademarks, and if any copyright or trademark holder wishes a specific acknowledgment, notify us, and we will be happy to add it where appropriate.



46.1 Bacula Bugs

Well fortunately there are not too many bugs, but thanks to Dan Langille, we have a bugs database where bugs are reported. Generally, when a bug is fixed, a patch for the currently released version will be attached to the bug report.

The directory **patches** in the current SVN always contains a list of the patches that have been created for the previously released version of Bacula. In addition, the file **patches-version-number** in the **patches** directory contains a summary of each of the patches.

A "raw" list of the current task list and known issues can be found in **kernstodo** in the main Bacula source directory.